

GRINDING: AN OVERVIEW OF  
OPERATION AND DESIGN

by

John W. Schlantz  
Mineral Processing Engineer

ABSTRACT

This paper was specifically prepared for presentation at a mill operators symposium held in Spruce Pine, NC in October of 1987. The purpose of this discussion was to review grinding concepts and show how better understanding of these concepts are leading to new ideas in the design of comminution circuits. This paper covers topics relating to grinding mechanisms and laws, energy relationships, types of mills, control factors and design of such circuits.

## TABLE OF CONTENTS

|  |    |
|--|----|
| ABSTRACT . . . . .                                   | i  |
| INTRODUCTION . . . . .                               | 1  |
| GENERAL REVIEW . . . . .                             | 2  |
| Breakage Forces . . . . .                            | 3  |
| Grinding Laws . . . . .                              | 5  |
| TUMBLING MILLS . . . . .                             | 7  |
| Characteristics . . . . .                            | 8  |
| Types . . . . .                                      | 9  |
| Rod Mills . . . . .                                  | 10 |
| Ball Mills . . . . .                                 | 12 |
| Autogenous Mills . . . . .                           | 15 |
| Grinding Circuits . . . . .                          | 16 |
| Open Circuit Grinding . . . . .                      | 17 |
| Closed Circuit Grinding . . . . .                    | 18 |
| CONTROL OF CIRCUITS . . . . .                        | 19 |
| Variables . . . . .                                  | 19 |
| Automatic Control . . . . .                          | 21 |
| CIRCUIT DESIGN . . . . .                             | 22 |
| Bond Method . . . . .                                | 23 |
| Step 1: Grindability Test . . . . .                  | 23 |
| Step 2: Conversion to an 8 ft. Mill . . . . .        | 24 |
| Step 3: Allowance for Size Reduction Ratio . . . . . | 25 |
| Step 4: Scale-up to Larger Mills . . . . .           | 25 |
| Step 5: Corrections for Milling Conditions . . . . . | 26 |
| PSU GRINDING CIRCUIT SIMULATOR . . . . .             | 26 |
| REFERENCES . . . . .                                 | 31 |

TABLE OF CONTENTS (cont.)

|          |   |         |
|----------|---|---------|
| Fig. 1.  | Breakage Mechanisms . . . . .                         | 32      |
| Fig. 2.  | Grinding Laws . . . . .                               | 33      |
| Fig. 3.  | Patterns of Tumbling . . . . .                        | 34      |
| Fig. 4.  | Classification of Rod Mills . . . . .                 | 35      |
| Fig. 5.  | Determination of Media Charge . . . . .               | 36      |
| Fig. 6.  | Grinding Action in Rod Mills . . . . .                | 37      |
| Fig. 7.  | Classification of Ball Mills . . . . .                | 38      |
| Fig. 8.  | Open Circuit Grinding . . . . .                       | 39      |
| Fig. 9.  | Closed Circuit Grinding . . . . .                     | 40      |
| Fig. 10. | Grinding Circuit Variables . . . . .                  | 41      |
| Fig. 11. | Bond's Equations . . . . .                            | 42      |
| Fig. 12. | Equations for Size Mass Balance Method . . . . .      | 43      |
| Fig. 13. | Nomenclature Utilized in PSU Simulator . . . . .      | 44 - 45 |
| Fig. 14. | Grinding Circuits in PSU Grinding Circuit Simulator . | 46      |

GRINDING: AN OVERVIEW OF  
OPERATION AND DESIGN

by

John W. Schlantz  
Mineral Processing Engineer

North Carolina State University  
Minerals Research Laboratory  
180 Coxe Avenue  
Asheville, North Carolina 28801

## INTRODUCTION

The importance of comminution circuits in any mineral processing facility is often misunderstood or, at the very least, not fully appreciated. Grinding, because it is normally the final stage of this comminution, takes on a special importance and is often described as the key to successful plant operation and production.

The grinding circuits carry responsibilities that can have an impact on all phases of the operation, including efficient mill operation and successful production, with its main purpose being to exercise close control on product size. In other words, the grinding mill must produce an optimum mesh of grind.

An optimum mesh of grind is important for several reasons, with the most basic being achievement of liberation of the mineral species contained in the ore. If the mill is not grinding fine enough, or undergrinding the ore, it produces a product which is coarse and may have a low degree of liberation, which will result in poor recoveries, poor concentration ratios and uneconomical operation. Other factors which contribute to the importance of this optimum mesh of grind is consideration of downstream processing and possible customer size specifications imposed on the product.

Probably the most critical reason for good control over the

grinding circuit is associated with the tremendous amount of energy consumed in this unit process. It is no great secret that grinding circuits are the largest power consumer and most costly phase of most operations and it has been estimated that 50% of the 100 billion kilowatt hours of electricity used in U. S. mills per year can be attributed to the grinding circuits. An extra 19% of power must be supplied to grind the ore to one screen size finer based on standard size scales.

Because of the aforementioned reasons, responsible and efficient operation of grinding circuits is critical and much of this responsibility will fall on the personnel who operate these circuits. Recent research is showing that the mechanisms of grinding are very complex and it is felt that a basic understanding of grinding concepts may lead to improved operation. Therefore, this discussion will focus on providing some general knowledge concerning grinding, covering topics such as grinding laws, types of mills and how they operate, critical variables and how they can be controlled, and some comparisons of design methods which show how grinding concepts have evolved.

#### GENERAL REVIEW

In order to appreciate what is actually taking place in a grinding mill it may be helpful to review some of the mechanisms of breakage, energy relations and laws that attempt to explain these occurrences.

### Breakage Forces

Basically materials can be classified into two categories. A material is either described as ductile or brittle. A ductile material, when stressed to failure, will normally break into two pieces. Stressing of a brittle material will result in shattering, or breakage into many pieces of different sizes of which the fracture paths cannot be controlled. Because ore behaves as a brittle material, the pattern of breakage presents problems in grinding by attempting to create fracture within specified limits without having any control over the fracture process.

There are several mechanisms through which breakage of a particle can occur (Fig. 1). These mechanisms are:

- 1) Impact or Compression - Forces Applied Normally
- 2) Chipping - Forces Applied Obliquely
- 3) Abrasion - Forces Applied Parallel

Regardless of the mechanism involved, in any fracture process the particle must be raised to a state of strain which will initiate the propagation of fracture cracks. In order to create this state of strain, energy greater than or equal to the stored strain energy of the particle must be supplied. The factors that decide how much energy is required to overcome this stored energy are:

- 1) Presence of preexisting cracks or flaws
- 2) Degree of plastic flow in the solid vs. complete brittleness

### 3) Geometry and rate of stress application

In most mills, the forces which act on a particle to create fracture can occur thru one or more of several means, which include:

- 1) Collision between particles
- 2) Pressure loading on the particles
- 3) Shear and abrasion by particles falling through the grinding media
- 4) Impact of falling media on particles
- 5) Shock transmitted through a crop load, or packed bed

Therefore, when deciding upon the required energy, or the power which must be supplied to a grinding mill, several factors must be considered.

- 1) Efficient conversion of input energy to mechanical action
- 2) Efficient transfer of the mechanical action to the particle
- 3) Matching the stress produced by the mechanical action to the failure stress of the particles

Unfortunately, most of the energy supplied to a grinding mill is lost primarily as heat, noise and deformation of rock and equipment. Only a small amount of the supplied energy actually reports as energy of new surfaces created from broken products although this is the true value of useful energy consumed in the mill. This is the direct reason why grinding circuits are so cost intensive.



### Grinding Laws

Over the years, many attempts have been made, in the form of mathematical laws, to explain the relationships of energy, breakage and particle size (Fig. 2).

The first of these laws was Rittinger's Law, which states that the energy required for fracture is proportional to the new surface produced. This relationship can be expressed mathematically as:  $E_R = C_R (1/d_2 - 1/d_1)$  Where  $C_R = \text{Constant}$

$d_2 = \text{Product Size}$

$d_1 = \text{Feed Size}$

This law requires that the grinding rate function is proportional to particle size which would be the case only for very hard materials over limited size ranges.

Rittinger's Law was followed by Kick's Law, which formed the basis that the energy required for fracture is proportional to the volume broken. This law can be expressed as:

$$E_k = C_k \log (d_2/d_1)$$

This law implies that grinding rate is independent of particle size because it is based on a constant and a reduction ratio, indicating equal amounts of energy would be required to achieve size reductions regardless of particle size. However, it is well known that more energy is required for fine grinding as compared to coarse grinding, thus it is felt this law is valid for very short grinding times with particles confined in coarse size ranges.

Probably the most accepted law was that of Bond, which tends

to fall between Kick and Rittinger. Bond's basis was that work input is proportional to the new crack tip length produced in particle breakage and equals the work represented by the product minus that represented by the feed. Bond's law is characterized by the well known Bond Work Index and can be expressed as:

$$W = \frac{10 W_i}{\sqrt{P}} - \frac{10 W_i}{\sqrt{F}}$$

Where W = work input            P = 80% passing size of product

W<sub>i</sub> = work index            F = 80% passing size of feed

Bond's Law has been found to apply reasonably well in the range of conventional rod mill and ball mill grinding.

Other laws, such as those proposed by Charles and Holmes, have been investigated and all seem to have similar flaws, which include:

- 1) All are based on an applied energy to size reduction relationship which is considered too simplistic for such a complex process.
- 2) They do not apply to the entire spectrum of size ranges.
- 3) All were very liberal with assumptions.
- 4) They do not consider mechanical concepts such as recycle ratios, classifier effectiveness, optimum media charges, lifter designs, changes in mill feed, etc.
- 5) They are all purely empirical relationships evolved from fitting laboratory data to predictable equations and relationships.

Because of these discrepancies in the older laws, a newer

method is being evolved which considers factors such as mill size, mill power (specific grinding energy), efficient grinding conditions, recycle and classification efficiencies, mill circuit behavior under varying conditions, mill selection for complex circuits and economic optimization. This new method is termed the size-mass balance concept.

The size-mass balance method is based on knowing how quickly a certain size particle breaks and in what sizes its products appear. This method combines concepts of specific rates of breakage, residence time distributions and mathematical descriptions of classification plus a set of relationships which describe how each factor in the size-mass balance varies with mill conditions and mill size. With such methodology circuits can be simulated, compared and optimized for technical and economic performance on paper before a final design is adopted. This method will be described in more detail later in this discussion.

#### TUMBLING MILLS

Most grinding, whether done wet or dry, is usually performed in rotating cylindrical steel vessels known as tumbling mills. These mills usually contain a charge of loose crushing bodies, or grinding medium, which is free to move inside the drum. The grinding media normally employed is steel rods or balls, ceramic pebbles, hard rock, or, in some instances, the ore itself.

### Characteristics

Regardless of the grinding media utilized all tumbling mills effect breakage according to the same basic principles. As the mill rotates the grinding charge is raised from a level surface position with liners preventing slippage of the charge so that the media moves with the shell until they fall and tumble down over the mass of the charge. The pattern in which the charge tumbles is directly related to the speed of rotation of the mill (Fig. 3).

The various tumbling patterns are described as cascading and cataracting. Cascading describes the portion of the media that tends to roll down to the toe of the mill which results in abrasive-type comminution, leading to finer grinding and increased liner wear. Cateracting is experienced by the portion of the charge that is raised high enough in the mill to actually fall back down to the toe. This action leads to impact comminution, which produces a coarser product. Most mills utilize a combination of the two in actual operation.

As stated, all tumbling patterns are a result of the rotational speed of the mill. A critical speed does exist for each mill that creates centrifuging of the charge and no tumbling action occurs. The media is theoretically carried around in a fixed position against the shell. This critical speed can be calculated for any tumbling mill using the formula (Fig. 3):

$$N_C = \frac{42.3}{\sqrt{D-d}}$$

Where  $N_C$  = Critical speed

$D$  = Mill diameter

$d$  = Charge diameter

All tumbling mills are operated at a percentage of this critical speed to achieve the correct tumbling patterns.

Even though tumbling mills have been developed to a high degree of mechanical efficiency and reliability they are still extremely wasteful in terms of expended energy because, even with correct tumbling action of the medium, ore is broken as a result of repeated, random impacts, indicating that grinding is subject to the laws of probability. This indicates that the tumbling mill merely provides a vehicle in which a multitude of fracture opportunities exists, leading to perhaps a definition that it is a device for converting electrical energy into mechanical energy and incidentally causes fracture in the process.

### Types

Tumbling mills are categorized according to the grinding medium utilized. There are three basic types:

- 1) Rod mills
- 2) Ball mills
- 3) Autogenous

Rod mills, obviously, are charged with steel rods while ball mills employ steel or ceramic balls, or pebbles. The autogenous mills are charged with large pieces of the ore itself, which

serve as the actual grinding medium.

### Rod Mills

Rod mills are often described as fine crushers or coarse grinders as they do produce a relatively coarse product, taking feed as coarse as 50 mm with products as fine as 300 mm (50 mesh) with reduction ratios of 15 - 20 to 1. A distinctive feature of rod mills is that its length is 1.5 to 2.5 times the diameter. Because rods longer than 6 m tend to bend, a maximum size for rod mills does exist.

Rod mills are classified according to the type of discharge (Fig. 4). There are 3 main categories:

- 1) Center Peripheral Discharge - This unit is fed at both ends thru the trunnions and discharged thru ports spaced along the center. Normally gives a coarse grind with minimum fines and has a limited reduction ratio.
- 2) End Peripheral Discharge - This type is fed thru one trunnion end and discharges from the other end by means of several peripheral apertures. It is used mainly for dry and damp grinding, producing a moderately coarse product.
- 3) Overflow Discharge - This rod mill is the most widely used and is fed thru the trunnion at one end and discharged thru the trunnion at the other end. It is used for wet grinding only with its principle function being the conversion of crushed product to ball mill feed, although it is often used to produce a final grind.

Rod mills are initially charged with a selection of assorted

diameter rods calculated to provide a maximum grinding surface and to approximate a seasoned load. The maximum size media can be calculated from the following equation (Fig. 5):

$$M = \frac{FW_i}{KC_s} \frac{S}{\sqrt{D}}$$

Where: M = dia. of topsize media in inches

F = 80% passing size of the feed (microns)

$W_i$  = work index

$C_s$  = percent of critical speed

S = specific gravity of feed

D = inside mill diameter

K = constant, 200 for ball mills, 300 for rod mills

Once the top size of rods has been determined, the initial charge can be made up according to the chart shown in Fig. 5. These sizes will range from 5 in. to 1-1/2 in. in diameter (150 to 25 mm). It should be noted that this data supplies a good starting point but optimum charge is normally determined thru trial and error practices. The rod charge normally occupies 35% of the mill volume with a void space of 22% of this. The new stacked rod charge should weigh approximately 382 lb/ft<sup>3</sup>. Overcharging of the mill will result in inefficient grinding and increased wear.

To maintain optimum grinding conditions, worn rods (less than 25 mm in diameter) should be replaced with fresh rods of the maximum diameter. Rod consumption (wear) is usually in the range of 0.1 to 1.0 kg of steel per ton of ore.

Rod mills are normally operated at 50 to 65% of critical speed. This allows the rods to tumble in a cascading-type pattern instead of cataracting, which tends to tangle the rods. Pulp densities usually range from 60 to 75% solids with finer feeds requiring lower pulp densities, although optimum conditions are ultimately dictated by the ore itself.

Actual grinding action results from line contact of rods on particles (Fig. 6). The coarse feed tends to spread the rods at the feed end producing a wedge or cone shaped array. This creates a tendency for grinding to take place preferentially on larger particles, thus producing minimum fines. This action gives a product of relatively narrow size ranges with little oversize or slimes. Because of this controlled size reduction rod mills are nearly always run in open circuit.

Rod mill grinding does present several cost advantages which should be considered when selecting a mill. These advantages are:

- 1) The size distribution of the product is controlled by the grinding action, virtually eliminating the need for closed circuit equipment.
- 2) The grinding medium is low cost.
- 3) Rod mills generally have high grinding efficiencies with low steel consumption as compared to other mills.

### Ball Mills

Conventional ball mills are generally characterized with



shorter length to diameter ratios of the magnitude of 1.5 to 1.0. Ball mills with ratios of 3 to 5 are designated as tube mills, which are divided into several compartments with each compartment having a different ball charge. Tube mills with only one compartment are termed pebble mills. In industrial minerals applications, pebble mills are normally used for fine grinding and usually contain ceramic liners and ceramic-type media to avoid contamination. In some circumstances, coarse, hard rock pebbles may constitute the grinding medium.

Ball mills, like rod mills, are classified according to the type of discharge the mill is equipped with. The two types of discharge are (Fig. 7):

- 1) Grate Discharge - These mills are fitted with discharge grates between the cylindrical mill shell and the discharge trunnion. This type discharge requires a lower pulp density than others which reduces retention times, resulting in very little overgrinding but also discharges a large fraction of coarse particles, necessitating closed circuit operation.
- 2) Overflow Discharge - This ball mill discharge is very similar to the rod mill overflow discharge although many times a scalping screen is needed to collect smaller or worn grinding medium which may overflow with pulp. This type is the simplest to operate and is the most used. Power consumption may be as much as 15% less than the grate discharge mill although grinding efficiencies are nearly equal.

Control of the product size thru the grinding action in a ball mill is inferior to that associated with the rod mills. This is due to the grinding action being a purely random process with the probability of a fine particle being struck the same as that of a coarse particle being struck. If run in open circuit, this results in a product with a wide range of particle size and overgrinding becomes a problem. Closed circuit operation lessens this effect and most ball mill circuits are operated in this mode.

Pulp densities in ball mills are maintained as high as possible, usually in the range of 65 to 80% solids. This allows the balls to be coated with a layer of ore. If the pulp becomes too dilute metal to metal contact increases, resulting in increased steel consumption and inefficient grinding. Like the rod mill, finer grinding requires a more dilute pulp.

The ball charge should contain as small balls as possible to offer the greatest grinding area. The largest balls should be just heavy enough to break the coarsest particle. An accurate seasoned charge will consist of a wide range of ball sizes. The optimum ball charge can be determined the same as for rods, using the equation shown in Fig. 5 to calculate the top ball size. Once this top size is determined the proper distribution can be chosen from the chart in Fig. 5. As with the rod mill, replacement balls should be of the largest required. Steel consumption is again in the range of 0.1 to 1.0 kg per ton of new feed.

The media charge in a ball mill is normally larger than that of the rod mill, occupying 40 to 50% of the total mill volume. A ball charge generally weighs out at 280 lbs./ft<sup>3</sup> giving a void space of 44% of the volume occupied by the charge.

Ball mills are also normally operated at higher speeds than rod mills, usually between 70 to 80% of critical. This allows more of a cataracting action of the charge, which results in more impact on the particles.

### Autogenous Mills

In autogenous mills comminution is achieved by the action of the ore particles on each other. Usually coarse rock is screened from the crusher circuit and stored for grinding medium. This type of grinding is becoming increasingly popular because, if the ore is susceptible to this grind, medium costs can be eliminated.

Autogenous mills generally have a large diameter relative to length, such as the cascade mill and are run at high speeds of 80 to 85% of critical. The load volume is in the range of 35 to 40% of the total and these mills can effect very large reduction ratios. The product size is generally in the range of the natural grain size or crystal size of the ore.

This type of grinding is used most often on friable, grainy material such as silica rock, asbestos, slag, bauxite, dolomite, ferrosilicon, limestone, taconite and cement clinker. More detailed testing is also required initially because all ores cannot be treated in this manner and, although medium costs are eliminated, overall power consumption can be much higher than

conventional grinding.

### Grinding Circuits

There is no such thing as a "best" configuration of equipment for grinding. The circuit which works well on one ore may be totally unsatisfactory for another ore. The general trend in industry today is flowsheet simplification, using larger parallel circuits instead of multiple-line circuits with smaller mills. This change has been brought about by the savings of both capital and operating costs that are associated with larger equipment.

In any grinding installation a choice must be made between wet or dry grinding. Most mineral processing facilities utilize wet grinding, which has the following advantages over dry grinding:

- 1) lower power consumption per ton of product
- 2) higher capacity per unit of mill volume
- 3) makes possible the use of wet screening or classification for close product control
- 4) elimination of dust problems
- 5) allows the use of simple handling and transport methods (i.e., pumps, pipes, launders, etc.)

A choice must also be made between open and closed circuit operation. While both have their own advantages, the final decision is usually based on factors such as mill selection, product requirements, tonnage requirements and ore

characteristics.

### Open Circuit Grinding

Open circuit grinding consists of one or more grinding mills, either parallel or in series, that discharges a final ground product without classification equipment and no return of coarse discharge back to the mill. Some very simplistic examples of open circuit grinding are (Fig. 8):

- 1) Rod mill
- 2) Ball Mill
- 3) Rod mill, ball mill combination

Not all ores can be ground in an open circuit type of arrangement. Some conditions which do favor open circuit grinding are:

- 1) small reduction ratios
- 2) reduction of particles to a coarse, natural grain size
- 3) recirculation of cleaner flotation middlings for regrinding
- 4) a non-critical size distribution of the final ground product

Some advantages of operating in the open circuit mode vs closed circuit are:

- 1) minimum equipment requirements
- 2) high pulp density discharge
- 3) simplicity of operation

### Closed Circuit Grinding

Closed circuit grinding consists of one or more mills discharging ground product to classifiers which in turn return the coarse product from the size separation back to the mill for further grinding. In this circuit, grinding efficiency is very dependent upon the size separation effected so care should be exercised in selecting the type and size of classifier used to close the system.

This type of grinding is the most common circuit found in mineral processing facilities, mainly because a lot of ores and product requirements are not suitable for open circuit grinding. Some advantages presented by grinding in closed circuit are:

- 1) This arrangement usually results in higher mill capacity and lower power consumption per ton of product.
- 2) It eliminates overgrinding by removing fines early.
- 3) It avoids coarse material in the final ground product by returning this material to the mill.

Although closed circuit grinding offers many choices for arrangement of the equipment as well as combinations of equipment, some of the more common circuits are (Fig. 9):

- 1) Rod mill/Classifier
- 2) Ball mill/Classifier
- 3) Rod mill/Ball mill/Classifier
- 4) Rod mill/Classifier/Ball mill/Classifier

### CONTROL OF CIRCUITS

The importance of the grinding circuit to overall production in any facility should be obvious by now. Because of the responsibilities assigned to grinding it becomes essential that a grinding mill accepts a certain required tonnage of ore per day while yielding a product that is of a known and controllable particle size. This leads to the conclusion that close control over the grinding circuit is extremely important.

#### Variables

There are many factors which can contribute to fluctuations in performance of a mill, but some of the most common found in industrial practice are:

- 1) changes in ore taken from different parts of the mine
- 2) changes in crusher settings
- 3) wear in the crushers
- 4) screen damage in the crusher circuit

These are a few things that operators should look for when changes in mill performance are noticed. Stockpiling of ore ahead of the mill can aid in smoothing out some of the fluctuations although it must be stored in such a manner that no segregation occurs.

In operating a grinding circuit, like any other unit process, variables key to the performance must be dealt with. Some of the principle variables affecting control of grinding mills are (Fig. 10):

- 1) changes in feed rate
- 2) changes in circulating loads
- 3) size distribution of the ore
- 4) hardness of the ore
- 5) rate of water addition
- 6) interruptions in operation (i.e., stoppage for replacement of grinding medium, clearing of choked classifiers, etc.)

Of these variables, feed size distribution and ore hardness are the two most significant because they can affect the actual grinding mechanics.

The only two variables that can be independently controlled by the operator are feed rate and water addition. All other variables depend on and respond to changes in these two items, thus these are used to control the grind. Too dilute a pulp, which can arise from a decrease in feed rate or an increase in water addition, will decrease retention time in the mill, resulting in a coarser product and increased wear. Under opposite circumstances, (high feed rate, decrease in water) pulp densities can become too high. This can lead to an increase in retention time resulting in a finer product. However, in most situations concerning too thick of a pulp the pulp viscosity will become so great that the grinding medium may begin to float and actual grinding will cease, and if not corrected, the mill will eventually choke.



### Automatic Control

Since grinding is extremely energy intensive and the product from grinding affects subsequent processes, close control is essential. It is now generally accepted that some form of automatic control is required.

In implementing instrumentation for process control the objective must first be clearly defined. Some examples of these objectives relating to grinding circuits may be:

- 1) to maintain a constant product size at maximum thruput
- 2) to maintain a constant feed rate within a limited range of product size
- 3) To maximize production per unit time in conjunction with downstream circuit performance.

Instrumentation to control process variables is receiving more and more attention lately. Some general methodology used to control some of the more critical variables are as follows:

- 1) Feed Rate - Variable speed belt feeders, audio controllers, which are sound sensitive devices that will measure feedrates according to noise levels in the mill.
- 2) Medium Charge - Can be controlled thru continuous monitoring of mill power consumption.
- 3) Flowrates and Densities - Can be measured with magnetic flowmeters and nuclear density gauges.
- 4) Sump Levels - Controlled by bubble tubes, capacitance type devices or other electronic devices.
- 5) Product Particle Size - Can be measured directly by the

use of on-line monitors or inferred thru mathematical modelling.

This is a very general run down of types or methods of control although specific devices are readily available. The best choice of controllers will depend on the characteristics of individual circuits.

### CIRCUIT DESIGN

There are many methods available to size grinding mills and to design grinding circuits. The majority of these methods have been around for some time and are largely a matter of using data from laboratory tests, applying empirical equations to this data, and fine tuning with correction factors that are often based on accumulated experience. Different manufacturers of grinding mills use different methods and it is at times difficult to check on the validity of the sizing estimates when estimates from different sources are widely divergent.

This part of the discussion will focus on two methods of sizing mills. The first will be the Bond method, which has been considered by most as the standard for a long time. The second will be a computer simulation developed at Penn State University which utilizes the relatively new concept (as applied to grinding) of the size-mass balance theory. These two methods are radically different in their approach and exemplify the differences between the older (empirical relationships) and more recent theories.

## Bond Method

The Bond method of sizing grinding mills has enjoyed wide acceptance in the mineral industry. It has two major engineering advantages, which are its simplicity and the fact that experience has shown that it does work for many (but not all) circumstances.

The Bond method can be broken down into 5 major components:

- 1) Standardized grindability tests on the material
- 2) An empirical equation which is designed to convert the test results to observed results in an 8 ft. diameter wet overflow mill operating in closed circuit with a circulating load of 250%.
- 3) An empirical equation to allow for overall reduction ratios in closed circuit operation
- 4) Scale-up relationships to predict results for larger mills
- 5) A series of empirical correction factors, based on experience, to allow for milling conditions

By looking at each of these 5 steps in detail, a good idea of the methodology of the Bond method can be obtained (Fig. 11).

### Step 1: Grindability Test

The Bond method does utilize a standard laboratory test procedure to supply the basic data. The feed for this test is crushed to 100% -6 mesh and approximately 80% finer than 2000 micron. The ore charge to be used is specified at 700 cm<sup>3</sup>, the weight of which is determined by packing the material in a graduated cylinder. This charge is then placed dry in a 12 X 12

in. mill rotating at 70 rpm (85% of critical) with a specified ball charge of:

43 balls - 1.75 in.

67 balls - 1.17 in.

10 balls - 1.0 in.

71 balls - 0.75 in.

95 balls - 0.61 in.

This ball charge should equal a total of 20.1 kilograms.

This charge, with the above conditions, is ground for a set number of revolutions, removed from the mill and sieved at the desired screen size. The undersize is removed and weighed while the oversize is returned to the mill with fresh feed added to reestablish the initial material charge weight. The new charge is reground and the process is continued until a constant 350% circulating load is achieved. At this point the net grams of screen undersize produced per mill revolution is determined ( $G_{bp}$ ).

#### Step 2: Conversion to an 8 ft. Mill

From the results of the grindability test (Step 1) a work index ( $W_i$ ) that is unique to the ore being tested can be determined using the following equation:

$$\text{eq.1} \quad W_i = (1.10)(4.45) \left| (P_1^{0.23})(G_{bp})^{0.82} \left[ \frac{10}{\sqrt{P_{80}}} - \frac{10}{\sqrt{F_{80}}} \right] \right. \text{kwh/t}$$

Where  $P_i$  = opening of test sieve in microns

$P_{80}$  = 80% passing size of the test product (microns)

$F_{80}$  = 80% passing size of the test feed (microns)

Step 3: Allowance for Size Reduction Ratio

Equation 1 calculates the work index which is used to calculate the specific grinding energy from the following equation:

$$\text{eq. 2} \quad E = Wi \left( \frac{10}{\sqrt{P_{80}}} - \frac{10}{\sqrt{F_{80}}} \right), \text{ kwh/t}$$

Where  $P_{80}$  = 80% passing size of circuit product

$F_{80}$  = 80% passing size of circuit feed

Step 4: Scale-up to Larger Mills

To convert to a larger mill than one having an 8 ft. diameter, the value of the work index ( $Wi$ ) must be scaled accordingly using the following equation:

$$\text{eq. 3} \quad Wi = (Wi)_{\text{test}} (2.44/D)^{0.2}, \quad D < 3.81\text{m (12.5 ft.)}$$

$$Wi = (Wi)_{\text{test}} (0.914), \quad D > 3.81\text{m (12.5 ft.)}$$

This allows a new specific energy to be calculated for larger mills from eq. 2.

Using the correct specific energy value ( $E$ ) for the desired mill diameter, the required shaft power for a desired feed rate can be determined from:

$$\text{eq. 4} \quad Mp = QE, \text{ kw}$$

Where  $MP$  = shaft power

$Q$  = feed rate

The shaft power,  $MP$ , can be related to mill power as a function of mill dimension using:

$$\text{eq. 5} \quad M_p = 7.33J \phi_c (1-0.937J) \left(1 - \frac{0.1}{2^9 - 10\phi_c}\right) (P_b LD^{2.3})$$

Where:  $P_b$  = density of grinding medium (t/M<sup>3</sup>)

$\phi_c$  = fraction of critical speed

$J$  = formal ball loading

$L$  = mill length

$D$  = mill diameter

All values in eq. 5 have either been determined or can be specified, therefore the necessary values of mill length necessary to give this power can be determined.

#### Step 5: Corrections for Milling Conditions

Correction factors for specific mill conditions can be calculated or taken from tables to adjust the work index,  $W_i$ . This may not be necessary, although equations and/or values are available for conditions such as allowances for oversized feed, fineness of grind, low reduction ratios and converting from closed circuit to open circuit.

#### PSU GRINDING CIRCUIT SIMULATOR

A simulation of any physical process is a mathematical model which behaves on computation in a manner identical to that of the real process. Generally, a simulation is only an approximation to the real behavior, especially for a process as complicated as milling and the mathematical models can be more or less complex depending on how closely one wishes to simulate the real situation.

The Penn State University Grinding Circuit Simulator

utilizes the size-mass rate balance concept in simulating a grinding circuit. This method uses two breakage concepts as its basis (Fig. 12).

1) Specific Rate of Breakage - fractional rate of breakage per unit of time per mass of the size particles are broken from. This is expressed mathematically by eq. 1 shown in Fig. 12.

2) Primary Breakage Distribution Function - Description of Function - Material breaks and the fragments produced are mixed back in with the general mass of powder in the mill. If this distribution of fragments can be measured before any of the fragments are reselected for further breakage, the result is the Primary Breakage Distribution. The mathematical expression for this function is also shown in Fig. 12.

These two principles sum up to define the overall basis of the program as the rate of some size  $i$  particles leaving the mill is equal to the rate of size  $i$  particles entering the mill plus the rate of production of size  $i$  particles from breakage of larger particles within the mill minus the rate of disappearance by breakage of size  $i$  particles within the mill.

The details of the program itself (i.e., flowsheet, computations, etc.) and the laboratory procedures required to generate much of the input data are much too complex to be included within this discussion. However, once the necessary data has been compiled, the program becomes very "user friendly,"

allowing easy input of the data as well as changing of conditions.

The program allows the selection of 5 basic mill circuits, which is an indication of the flexibility of the system. These circuits are (Fig. 14):

- 1) Open Circuit
- 2) Normal Closed Circuit
- 3) Reverse Closed Circuit
- 4) Open Circuit/Scalped Feed
- 5) Combined Closed Circuit

This is the first choice offered by the program. Once the proper circuit has been selected, it is shown on the monitor for verification. Following this selection, the program asks for the input data.

The required input data for simulation of the desired circuit includes feed size distribution, classifier size selectivity values, mill selection values, breakage values and time of grind. To be more specific, examples of required input are:

- . No. of size intervals desired in evaluation
- . No. of different ball diameters in both simulated and test mill
- . Diameter of both simulated and test mill
- . Maximum feed size
- . Scale-up constants which correspond to effects of mill and



- ball diameter on specific breakage rates and large particle size corrections
- . Operating conditions such as media charges, powder charges, and critical speeds utilized in both the simulated and the test mills
  - . Whether grinding is wet or dry
  - . Parameters for specific breakage rate calculations (determined from laboratory testing)
  - . Parameters for primary breakage distribution calculations (determined from laboratory testing) Four values are required for each ball diameter
  - . Feed size distribution
  - . Classifier data such as  $d_{50}$  values, sharpness index and apparent by-pass
  - . Time of grind

After all the data has been entered, the computer will calculate the specific rate of breakage, a residence time distribution for the simulated mill and the primary breakage function. The output generated will use these values to predict the performance of the simulated mill under the desired conditions. The predicted performance includes flowrates of each stream in the simulated circuit, predicted size distributions for each stream, classifier performance based on predicated mill discharge and % circulating loads, if applicable.

This simulation can be extremely helpful to operators of existing mills because it will automatically predict the

variation in mill output for different feed makeups, changed mill conditions and changed classifier parameters. Alternatively, from a design viewpoint, the effects of these same parameters on mill size, for a given feed rate, can also be predicted.

In contrast to other methods of design, this technique sizes the mill based on the rates of breakage occurring in the mill. The energy input necessary to run the mill then follows from the size and mechanics necessary to turn the device. This does seem to be a far more logical approach rather than estimating the energy first followed by making the mill big enough to consume this amount of energy.

REFERENCES

Prasher, C. L., Crushing and Grinding Process Handbook, Wiley and Sons Limited, New York, 1987.

Mular, A. L., Bhappu, R. B., Mineral Processing Plant Design, 2nd Edition, AIME, New York, 1980.

Austin, L. G., Klimpel, R. R., Luckie, P. T., Process Engineering of Size Reduction, AIME, New York, 1984.

Pryor, E. J., Mineral Processing, 3rd Edition, Elsevier Publishing Company, New York, 1965.

Wills, B. A., Mineral Processing Technology, 3rd Edition, Pergamon Press, New York, 1985.

Thomas, R., E/MJ Operating Handbook of Mineral Processing, McGraw-Hill, New York, 1977.

Brown, J. H., Unit Operations in Mineral Processing, International Academic Services Ltd., Ontario, 1979.

Fig. 1. Breakage Mechanisms

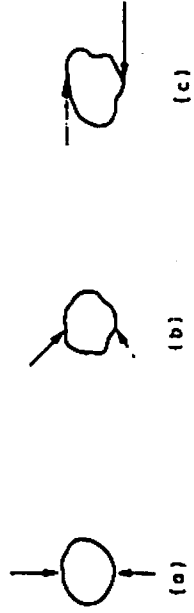

Mechanisms of breakage: (a) impact or compression, (b) chipping, (c) abrasion.

Fig. 2. Grinding Laws

Rittinger's Law

$$E_R = C_R (1/d_2 - 1/d_1) \quad \text{Where: } \begin{array}{l} E_R = \text{Specific Energy} \\ C_R = \text{Constant} \\ d_2 = \text{Product Size} \\ d_1 = \text{Feed Size} \end{array}$$

Kirk's Law

$$E_K = C_K \log (d_2/d_1) \quad \text{Where: } \begin{array}{l} E_K = \text{Specific Energy} \\ C_K = \text{Constant} \\ d_2 = \text{Product Size} \\ d_1 = \text{Feed Size} \end{array}$$

Bond's Law

$$W = \frac{10 W_i}{\sqrt{P}} - \frac{10 W_i}{\sqrt{F}} \quad \text{Where: } \begin{array}{l} W = \text{Work Input} \\ W_i = \text{Work Index} \\ P = 80\% \text{ Passing Size of Product} \\ F = 80\% \text{ Passing Size of Feed} \end{array}$$

Fig. 3. Patterns of Tumbling

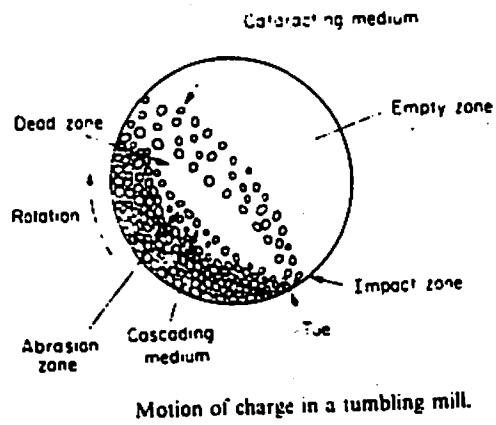

$$N_c = \frac{42.3}{\sqrt{D-d}}$$

Where  $N_c$  = Critical Speed  
 $D$  = Mill Diameter  
 $d$  = Charge Diameter

Fig. 4. Classification of Rod Mills

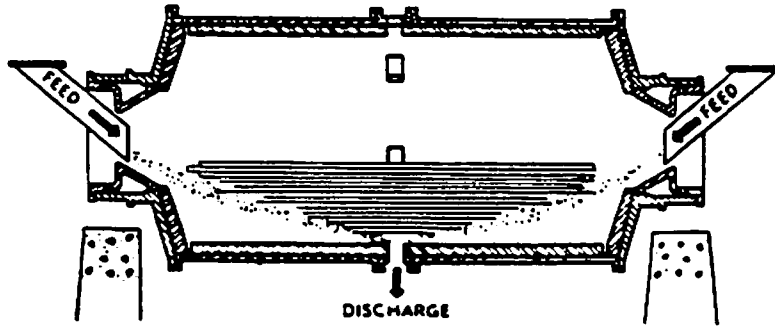

Central peripheral discharge mill.

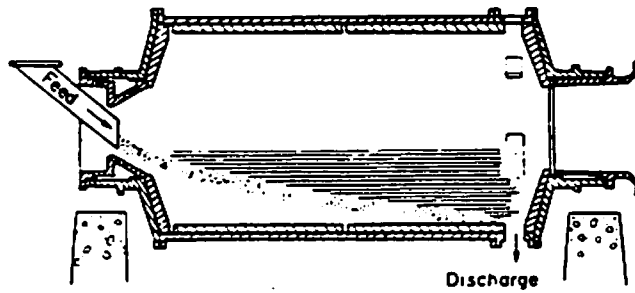

End peripheral discharge mill.

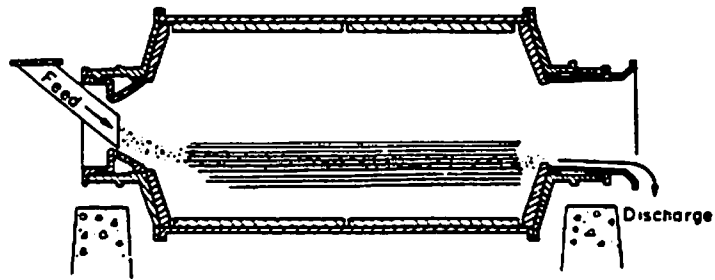

Overflow mill.

Fig. 5. Determination of Media Charge

$$M = \sqrt{\frac{FW_i}{KC_s}} \sqrt{\frac{S}{D}}$$

- M = diameter of topline media in inches
- F = size in microns of the screen opening which 80% of the feed will pass
- W<sub>i</sub> = work index
- C<sub>s</sub> = percent of critical speed
- S = specific gravity of feed
- D = diameter of mill inside liners in feet
- K = constant, the value of which is 200 for ball mills and 300 for rod mills

TABLE OF INITIAL CHARGES

| Rod Diameter (Inches) | Rod Size Distribution For Startup Charge (% Weight) |    |    |    |    |
|-----------------------|---|----|----|----|----|
|                       | 5   | 4% | 4  | 3% | 3  |
| 5                     | 19  |    |    |    |    |
| 4%                    | 17  | 21 |    |    |    |
| 4                     | 16  | 19 | 24 |    |    |
| 3%                    | 15  | 18 | 23 | 28 |    |
| 3                     | 13  | 17 | 20 | 22 | 30 |
| 2%                    | 10  | 15 | 18 | 20 | 28 |
| 2                     | 10  | 10 | 15 | 17 | 23 |
| 1%                    |   |    |    | 15 | 21 |

| Ball Diameter (Inches) | Ball Size Distribution For Startup Charge (% Weight) |      |      |      |      |      |      |      |      |      |      |     |
|------------------------|--|------|------|------|------|------|------|------|------|------|------|-----|
|                        | 5  | 4%   | 4    | 3%   | 3    | 2%   | 2    | 1%   | 1%   | 1    | %    | %   |
| 5                      | 17.0   |      |      |      |      |      |      |      |      |      |      |     |
| 4%                     | 25.0   | 18.0 |      |      |      |      |      |      |      |      |      |     |
| 4                      | 20.0   | 30.0 | 20.0 |      |      |      |      |      |      |      |      |     |
| 3%                     | 15.0   | 21.5 | 32.0 | 22.0 |      |      |      |      |      |      |      |     |
| 3                      | 10.0   | 14.0 | 21.0 | 35.0 | 26.0 |      |      |      |      |      |      |     |
| 2%                     | 6.4  | 9.1  | 12.5 | 19.0 | 36.0 | 22.0 |      |      |      |      |      |     |
| 2                      | 3.8  | 5.4  | 8.6  | 14.6 | 22.6 | 39.0 | 38.0 |      |      |      |      |     |
| 1%                     | 2.8  | 2.4  | 3.4  | 5.3  | 9.2  | 16.5 | 35.0 | 28.0 |      |      |      |     |
| 1%                     |  | 1.8  | 1.2  | 2.0  | 3.2  | 6.1  | 13.0 | 36.0 | 30.0 |      |      |     |
| 1                      |  |      | 1.3  | 1.0  | 1.7  | 2.9  | 6.4  | 16.0 | 32.0 | 22.0 |      |     |
| %                      |  |      |      | 1.1  | 1.3  | 1.4  | 3.1  | 8.0  | 14.5 | 52.0 | 24.0 |     |
| %                      |  |      |      |      |      | 2.1  | 4.5  | 12.0 | 23.5 | 26.0 | 78.0 | 100 |



Fig. 6. Grinding Action in Rod Mills

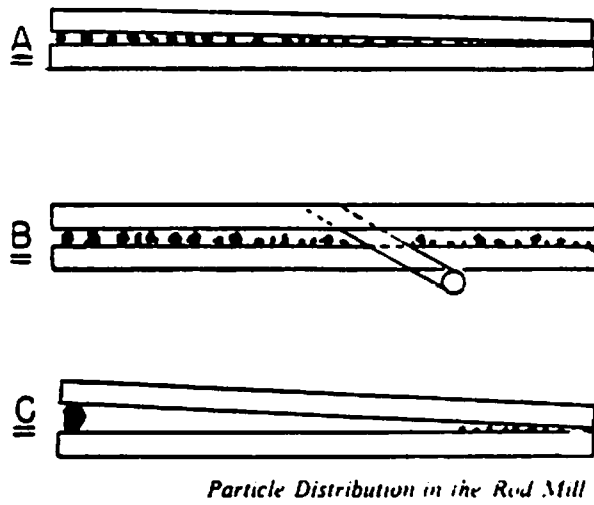
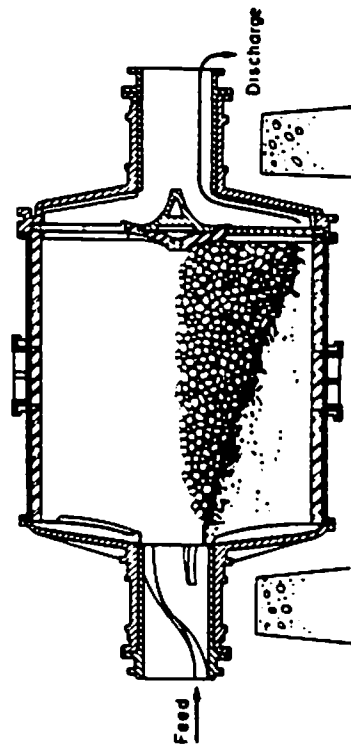
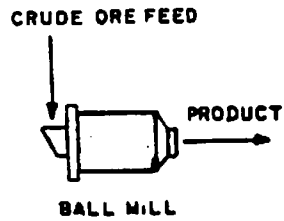
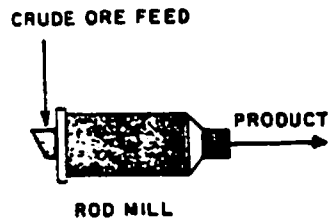
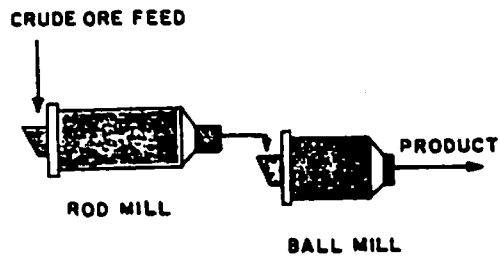

Fig. 7. Classification of Ball Mills



Grate discharge mill.

Fig. 8. Open Circuit Grinding



Open-Circuit Grinding

Fig. 9. Closed Circuit Grinding

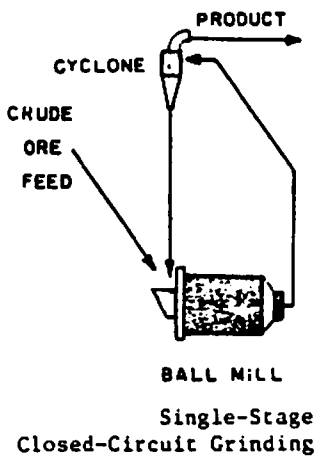
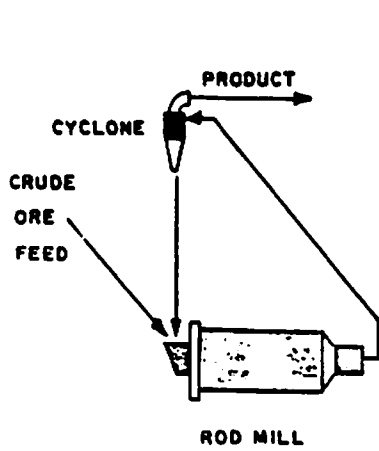

Single-Stage Closed-Circuit Grinding

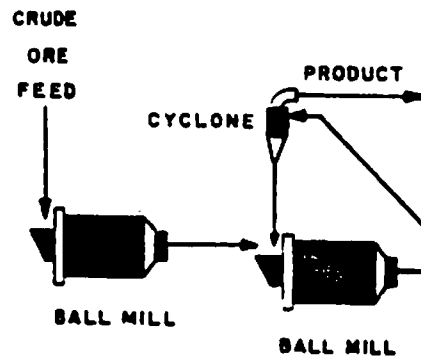

Ball Mill-Ball Mill, Closed-Circuit Grinding

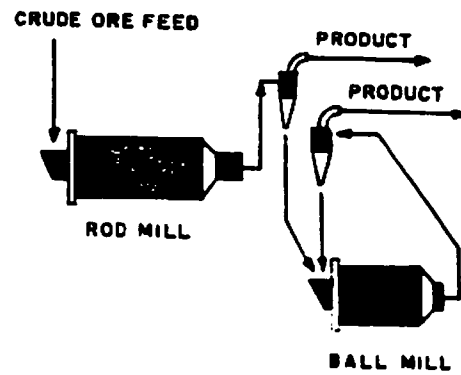

Two Stages Grinding and Classification

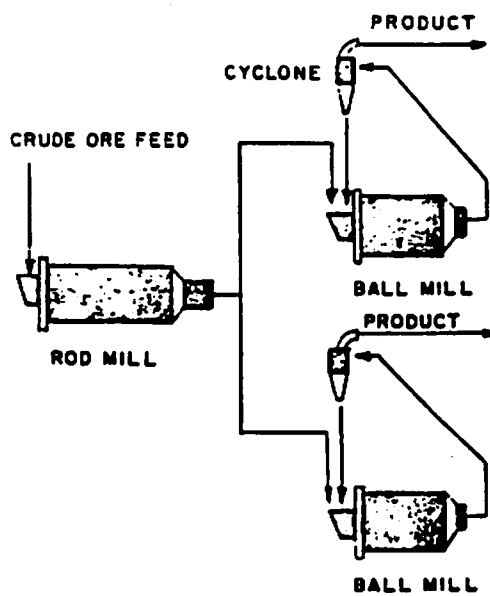

Rod Mill-Ball Mill, Closed-Circuit Grinding

Fig. 10. Grinding Circuit Variables

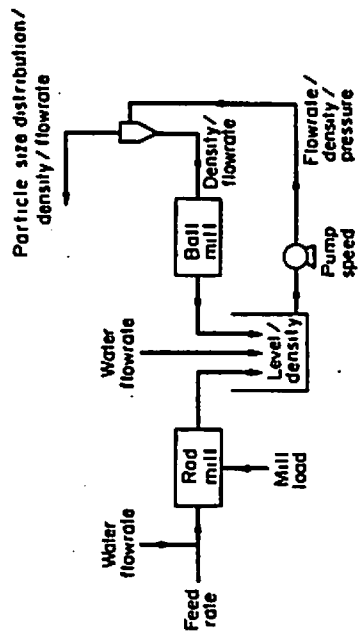

Grinding circuit control variables.

Fig. 11. Bond's Equations

$$\text{eq. 1} \quad W_i = (1.10)(4.45) \left( (P_1^{0.23})(G_{bp})^{0.82} \left[ \frac{10}{\sqrt{P_{80}}} - \frac{10}{\sqrt{F_{80}}} \right] \right)$$

Where:  $W_i$  = Work Index  
 $G_{bp}$  = Net gms per revolution  
 $P$  = 80% Passing Size of test product  
 $F$  = 80% passing size of test feed

$$\text{eq. 2} \quad E = W_i \left( \frac{10}{\sqrt{P}} - \frac{10}{\sqrt{F}} \right)$$

Where  $P$  = 80% passing size of circuit product  
 $F$  = 80% passing size of circuit feed

$$\text{eq. 3} \quad \begin{aligned} W_i &= (W_i)_{\text{test}} (2.44/D)^{0.2}, \quad D < 3.81\text{m (12.5 ft.)} \\ W_i &= (W_i)_{\text{test}} (0.914), \quad D > 3.81\text{m (12.5 ft.)} \end{aligned}$$

$$\text{eq. 4} \quad M_p = QE, \quad \text{Where: } M_p = \text{shaft power} \\ Q = \text{feed rate}$$

$$\text{eq. 5} \quad M_p = 7.33J \rho_c (1 - 0.937J) \left( 1 - \frac{0.1}{2^9 - 10\theta_c} \right) (P_b LD^{2.3})$$

Where:  $P_b$  = density of grinding medium ( $t/M^3$ )  
 $\theta_c$  = fraction of critical speed  
 $J$  = formal ball loading  
 $L$  = mill length  
 $D$  = mill diameter

Fig. 12. Equations for Size Mass Balance Method

SPECIFIC RATE OF BREAKAGE FUNCTION - SCALE UP FORMULAS

$$S_1(d) = a_T (x_1/x_0)^\alpha \left( \frac{1}{1+(x_1/C_{1T})^\lambda} \right) C_2 C_3 C_4 C_5$$

where

$$C_1 = (D/D_T)^{N_2} (d/d_T)^{N_3}$$

$$C_2 = (d_T/d)^{N_0} \left[ \frac{1+(d^*/d_T)^{\lambda^*}}{1+(d^*/d)^{\lambda^*}} \right]$$

$$C_3 = \begin{cases} (D/D_T)^{N_1} & D \leq 3.8m \\ \left( \frac{3.8}{D_T} \right)^{N_1} \left( \frac{D}{3.8} \right)^{N_1 - \Delta} & D \geq 3.8m \end{cases}$$

$$C_4 = \left( \frac{1+6.6J_T^{2.3}}{1+6.6J^{2.3}} \right) \exp[-c(U-U_T)]$$

$$C_5 = \left( \frac{\phi_c^{-0.1}}{\phi_{cT}^{-0.1}} \right) \left( \frac{1+\exp[15.7(\phi_{cT}^{-0.94})]}{1+\exp[15.7(\phi_c^{-0.94})]} \right)$$

BREAKAGE DISTRIBUTION FUNCTION

$$B_{i,1} = \phi_1 (x_{i-1})^Y + (1-\phi_1) (x_{i-1}/x_1)^B \quad n \geq 1$$

$$\phi_j = \phi_1 (x_j/x_1)^{-\delta} \quad \delta > 0, \phi_j \leq 1$$

FIGURE 13 - NOMENCLATURE UTILIZED IN PSU SIMULATOR

NOMENCLATURE

- A  $(x_i/u_T)/[(D/D_T)^{N_2}(d_{max}/d_T)^2]$  (-)
- b  $d_{min}/d_{max}$  (-)
- c constant in Eq. 1 which defines the effect of hold-up on breakage rates (-)
- d ball diameter (L)
- $d_T$  ball diameter used in laboratory test mill (L)
- $d_{max}$  make-up ball diameter (L)
- $d_{min}$  minimum diameter of ball in equilibrium ball charge (L)
- D mean internal mill diameter (L)
- $D_T$  D for the laboratory test mill (L)
- J volume fraction of mill filled by ball bed (-)
- $J_T$  J for the laboratory test (-)
- $m_k$  weight fraction of ball charge of ball size class k (-)
- $N_o$  exponent in Eq. 1, exponent of effect of ball diameter on specific breakage rates (-)
- $N_1$  exponent in Eq. 1, exponent of effect of mill diameter on specific breakage rates (-)
- $N_2$  exponent in Eq. 1, exponent of effect of mill diameter on large particle size correction (-)
- $S_i$  specific rate of breakage of particle size interval i, fraction per unit time (1/T)
- U fractional interstitial filling of voids of ball bed by particles (-)
- $U_T$  U for the laboratory test mill (-)



- $x_i$  upper size of particle size interval  $i$  (L)
- $x_o$  standard size (L)
- $x$   $d/d_{max}$  (L)
- $a_T$  pre-exponential factor in Eq. 1, proportionality factor for specific breakage rates (1/T)
- $\alpha$  exponential factor in Eq. 1, defines variation of specific breakage rates with particle size (-)
- $\Lambda$  factor in Eq. 1, defines the decrease in specific breakage rates of large particles (-)
- $\mu_T$  the particle size for which the specific breakage rate is one-half that expected from  $S_i = \alpha(x_i/x_o)^2$ , in the laboratory test mill with ball diameter  $d_T$  (L)
- $\phi_c$  rotational speed of mill as a fraction of critical speed (-)
- $\phi_{cT}$   $\phi_c$  for the laboratory test mill (-)
- $\phi_j$  is the intercept of the breakage distribution function - eqn (2)
- $\gamma$  is the slope of the lower side of the breakage distributions function - eqn (2)
- $\beta$  is the slope of the upper side of the breakage distribution function

Fig. 14. Grinding Circuits in PSU Grinding Circuit Simulator

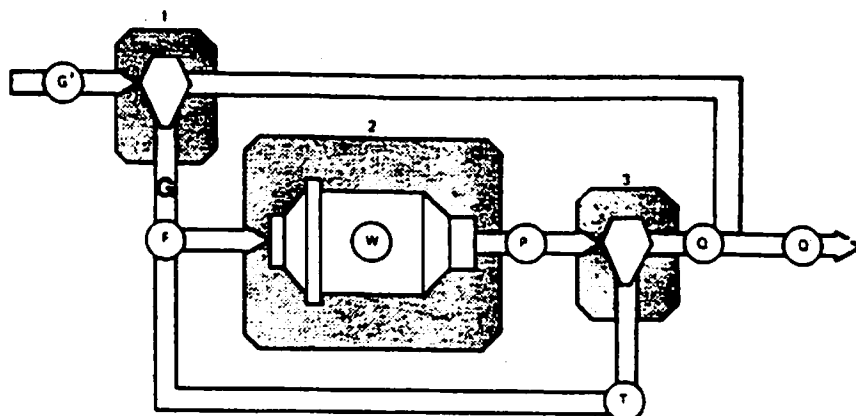
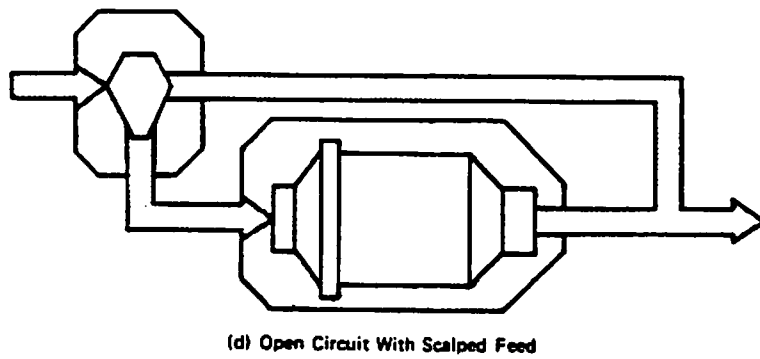
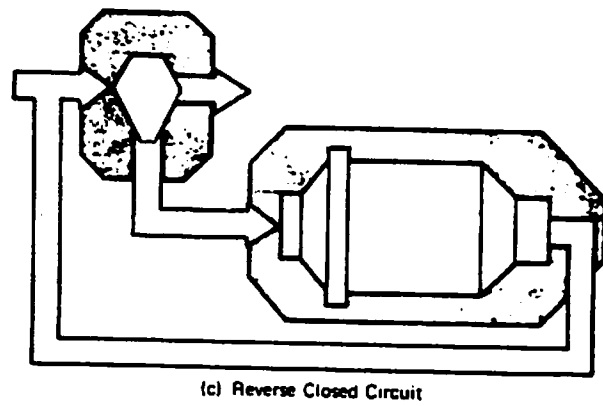
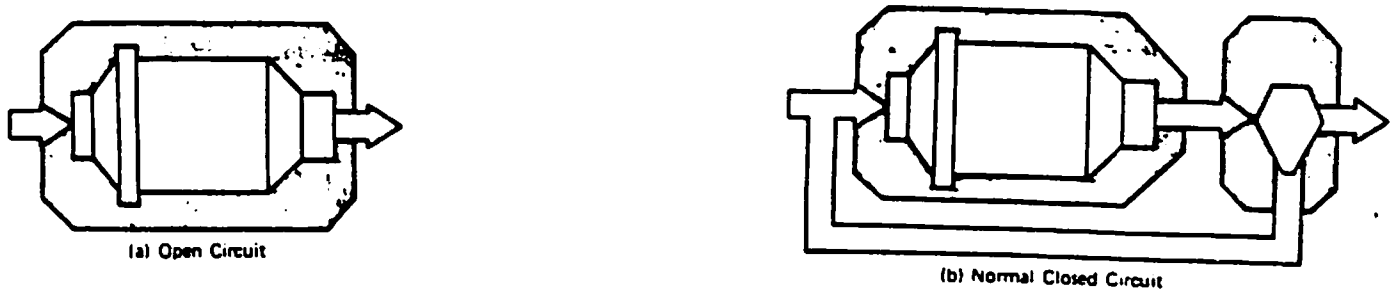

General single-stage mill circuit with pre- and post-classifier: the combined closed circuit.