

Roasting Arsenical Gold Ores and Concentrates

By F. R. ARCHIBALD*

(Annual General Meeting, Montreal, Que., April, 1949)

(Transactions, Volume LII, 1949, pp. 76-86)

INTRODUCTION

IT IS the purpose of this paper to review the subject of roasting as preparation of refractory gold ores and concentrates for cyanidation, with particular reference to operations at the mill of Beattie Gold Mines (Que.), Ltd., Duparquet, Quebec. Two earlier papers relating to the Beattie roasting operations (1,2) are cited as background to the present discussion, and more general reference is made to other publications relating to geology and metallurgy at Beattie (3,4,5). The Beattie roasting plant was built in 1937 as an addition to the existing flotation and cyanidation plant to permit complete processing of the ore at the mine property. Previously, the flotation concentrate had been cyanided, yielding 70 per cent of the gold values, followed by re-flotation of a concentrate from the cyanide residue. This re-floated residue was shipped to a smelter for recovery of gold values unavailable from direct cyanidation. The roasting plant itself is of interest through application in its design of multiple-hearth roasters and a Cottrell plant for separate recovery of dust and arsenic. In the laboratory and plant studies that accompanied development of the plant into a dependable and efficient working unit have been found principles and ideas applicable to other roasting problems. Before enlarging on these aspects relating particularly to the Beattie problems and plant, brief consideration is given to roasting in general.

GENERAL CONSIDERATIONS

The subject of roasting for metallurgical purposes generally has been covered by Dwight(6) and Hayward(7), and the literature on roasting gold and silver ores, up to 1940,

*Chemical Engineer. Oliver Iron Mining Company, Duluth, Minn.

was reviewed in detail by von Bernerwitz(8). Present discussion assumes the adequacy of these treatments and there will be added only such comments as serve to point up the ensuing discussion.

At the outset it is emphasized that each ore may present a special set of problems, the solution of which, or even a pattern for their solution, may not be found in any record of experience. In consideration of arsenical ores, however, particularly when the gold-bearing minerals are pyrite and arsenopyrite, there are general similarities that have been found to respond to the type of roasting procedure developed at Beattie. In one case as compared to another, it may be necessary to modify the temperature range, the time or other variable, and in some cases to add reducing or other chemical agents. The physical and chemical nature of a specific ore is necessarily accepted but, if the necessity for roasting is indicated, the treatment prior to the roasting step should be studied and engineered to suit the best interests of the roasting operation. For example, if a flotation step is employed, the requirements aimed at in the way of concentrate grade, particle size, and composition may be considerably different if it is planned to ship, smelt, roast, or cyanide the concentrate directly. This is a point that has not generally been emphasized. It may, for example, be preferable to float or otherwise add low grade or barren silica, or silicate gangue, to dilute the sulphide and arsenic mineral content. It may be possible by attention to grinding and flotation technique to avoid or reject siliceous slime components which are generally detrimental to roasting. In another case it might prove advantageous to mine and add pyritic ore, low or barren in gold values, with a view to aiding elimination of arsenic, and adding fuel in roasting. A

more obvious example would be rejection of barren or low grade arsenic minerals by selective flotation in cases where the gold is largely associated otherwise. This angle is emphasized, since too often, even in laboratory work, a concentrate is accepted for roasting studies or operations that could be modified to advantage by attention to the inherent nature of the ore and its preparation.

When the ore contains tellurides, copper, lead, antimony, carbonaceous matter, or other specific component that necessitates or influences roasting, special problems may arise. The present discussion is limited to arsenical and sulphide ores and concentrates, complicated only by the more usual silicate and carbonate gangue components.

Informative studies on the refractory nature of arsenical ores and compounds carrying gold values were reported by Leaver and Woolf (9) and the roasting procedure recommended by them in the paper cited, involving a short period roast at 450°C., is considered an important departure from the school of thought submitting a long, slow roast as the preferred procedure for arsenical ores. This matter is discussed at greater length in the following pages. At this point emphasis is laid on the demonstration by these authors that the presence of ferric arsenate is most detrimental and the detrimental effect can be largely eliminated by roasting with admixed pyrite. The same tendency, illustrated in the earlier papers on Beattie, and confirmed by later work, has been supplemented by later studies which show that elemental arsenic, when alloyed with gold, aids rather than hinders dissolution of gold in cyanide solution. The same appears to be true of gold-silver-arsenic alloys, which dissolve readily in cyanide solution. Evidence is that arsenic is most detrimental in the higher state of oxidation, particularly in the

presence of, or in combination with, iron oxide.

It was found that siliceous gangue slimes contributed to the refractory behaviour of Beattie concentrate and there is other evidence in the literature that finely ground silica and silicates are detrimental, particularly in the case of silver. Clevenger and Caron(10) reported the formation of silica-silver compounds in roasting, and Bouton, Riddell and Duschak(11) attributed similar results to adsorption of silver on the siliceous surfaces. Leaver and Woolf reported no evidence that gold behaved in this way, but investigation of the refractory components of Beattie ore gave evidence that dissolution of gold is hindered by the presence of finely ground siliceous components, particularly in the presence of a high proportion of silver. The presence of coarse silicate gangue, or calcite, does not appear to be detrimental, and the former can serve to advantage as a diluting material. It is not necessary, nor advisable, to liberate all the mineral particles from the gangue if they are finely disseminated, provided there are sufficient particles exposed to permit satisfactory concentration, and that a grinding operation follows roasting.

In consideration of roasting procedure, it is quite generally agreed that reducing conditions should be maintained in the early stages of the roast to ensure elimination of the arsenic in the arsenious state (1,2,9,12,13,14). Provided this has been satisfactorily accomplished, the finishing stages of the roast can be done under active oxidizing conditions. It is not enough that reducing conditions alone be maintained during the period of arsenic elimination as it is also necessary to maintain movement of the charge and a good flow of gas over or through the charge to carry off the arsenious oxide as it is produced. Laboratory procedure in particular is apt to err in this regard if the roasting is done in a closed muffle. Sulphur, present in the arsenopyrite and ordinarily also in varying proportions of other sulphides, is a satisfactory source of reducing agent and atmosphere, and full advantage should be taken of its presence for that purpose. In specific cases it may be necessary to add coal, coke, or other extraneous reducing agent, or to use chemical agents such as sodium chloride, but it is believed that, if full advantage is taken of the possibilities inherent in the ore or concentrate, and application of physico-chemical principles to them, more satisfactory and economical results will be obtained than by application of nostrums. Many

ideas were tried in the Beattie laboratory and a few were given trial in the plant, but none of them gave as good improvement, or promise of improvement, as the less spectacular devices resulting from patient attention to improvement and control of flotation and the operation of the roasters in accordance with guidance from laboratory studies and detailed operating data.

A second important consideration in roasting procedure is that of the time-temperature sequence. More complete elimination, or inactivation, of arsenic, and prevention of undesirable side reactions, can be accomplished by control of temperature to follow a generalized curve illustrated in the earlier papers on Beattie roasting and repeated later in this presentation. The variables of temperature, SO_2 concentration, and rate of roasting are interdependent and may conveniently be represented on one diagram(2). The word 'inactivation' of arsenic is used through observation that gold extraction from roasted calcine, though generally so, is not necessarily a function of the percentage of residual arsenic. The naturally occurring ratio of pyrite to arsenopyrite, and the total content of these minerals, will affect the shape of the most desirable curve. For Beattie concentrate, it proved best to hold the temperature about 900°F . during the period of arsenic elimination, followed by a rise to $1,300^\circ$ before completion of the roast. These general principles have been applied with success to other arsenical ores in laboratory studies and at least one operating plant(14).

More recent work on an ore carrying a much higher proportion of arsenopyrite than pyrite has shown that, in this case, the temperature at which the arsenic is eliminated can be advantageously raised to $1,250^\circ\text{F}$. In consideration of the lower heat of combustion of arsenopyrite and the lower content of sulphur to carry off the arsenic, it is understandable that this should be so and it is not considered contradictory to the general principles stated.

In considering the matter of roasting-plant design, the basic character is set by the type of roaster selected. There are three general types of roasting furnace in use—(1) the horizontal, multiple-spindle type, of which the Edwards furnace and modifications of it are typical; (2) the rotary kiln; and (3) the vertical, multiple-hearth furnaces with rabble arms attached to a central shaft, of which the Wedge furnaces used at Beattie are typical. Modifications of the vertical type in which the

number of hearths is reduced, and the distance between them thus increased in part of the furnace, are of advantage in some cases. Sulphur and arsenic are eliminated much more rapidly when the charge drops in thin streams through the furnace gases than when rabbled on a hearth. This is a fundamental difference in roasting behaviour in a multiple-hearth furnace as compared with the Edwards type of furnace and explains why the capacity of the former is so much greater per unit of hearth area. Reference to the literature on roasting gold ores and concentrates shows that the Edwards type has been the most popular in this field, although in the metallurgical field generally the multiple-hearth type is by far the commonest and the former practically confined in use to the metallurgy of gold. The use of a rotary kiln for roasting concentrate has not been widespread and it is probably significant that one such installation at Boliden has been discontinued in favour of Wedge type roasters where both had previously been in use(15).

The use of Wedge roasters at Beattie was a fortunate selection, if for nothing else than the fact that it was possible to roast concentrate with sulphur content of 15 per cent or even less, without the use of extraneous fuel. It was also possible to maintain a roasting procedure reasonably close to that found most suitable in laboratory tests. The manner in which this roasting procedure developed and a discussion of it is now given, followed by a description of the Beattie roasting plant and its operation.

LABORATORY STUDIES AND DEVELOPMENT OF THE BEATTIE ROASTING PROCEDURE

In the first operations at Beattie, a flotation concentrate assaying about 2 oz. gold per ton was made and shipped to the smelter at Tacoma, Washington. In 1934, a cyanide plant was added to permit recovery of 70 per cent of the value of the concentrate at the property and a shipping concentrate was made by re-flotation of the cyanide residue. There were a number of economic advantages to this procedure, but the chief metallurgical advantage was that the combination permitted better flotation recoveries through removal of the necessity for a high-grade sulphide concentrate in the first step.

It was obvious that advantages were still to be gained by complete processing of the ore at the mine, provided a satisfactory method of

treatment could be found. First trials at roasting with conventional procedures did not give good promise and it was hoped that the necessity for burning off the sulphur and arsenic and collecting the latter could be avoided. Such a process was proposed by Professor G. J. MacKay, of Queen's University, and a lot of work was put on it both at the University and the mine. In addition to the laboratory studies, a pilot plant was built and operated for several months, on a scale in keeping with the specially built 6-foot-diameter, 3-hearth muffle-fired Wedge-type furnace. The capacity of this furnace was 2 tons of concentrate per day.

This work was based on Professor MacKay's finding that, after heating arsenical ores or concentrates, mixed with soda-ash equal to 5 to 10 per cent of their weight, in the absence of air for a period of 20 to 60 minutes at temperatures between 950° and 1,200°F., and then quenching in water, residues very low in gold values could be obtained by cyanidation of the calcine. Residues assaying as low as 0.05 oz. gold per ton were obtained from 2.00 oz. concentrate using this method. Difficulties due to dissolution of gold in the quench solution, the colloidal nature of these solutions, and the presence of considerable dissolved arsenic in them, were problems that yielded fairly satisfactorily to special treatments, but the continuous operation of a furnace for this purpose with exclusion of air was found impractical. This conclusion is considered worth recording since the most important reason for it may not be obvious. There was some distillation of arsenic sulphide from the charge, which, although largely retained within it, was subject to partial oxidation by the air in the charge and admitted through leaks. Arsenic sulphide with a slight admixture of arsenious oxide has a very low melting point and the presence of this sticky material made mechanical operation of the furnace practically impossible. A somewhat similar attempt to remove arsenic from sulphide-arsenopyrite ore at Boliden(16) by distillation of arsenic sulphide was abandoned, due partly to the same cause.

The writer has, through the intervening years, been intrigued by certain aspects of the MacKay process that, if pursued by intensive laboratory study, should throw revealing light on the causes underlying difficulties in extraction of gold from arsenical ores. For example, the

results of an early test using the MacKay procedure were as follows:

Head sample.....	2.00 oz. Au/ton
Cyanide heads.....	1.13 ..
Cyanide residue.....	0.016 ..
Extraction in quench sol'n	43.5%
Extract'n in cyanide sol'n	55.7%
Total extraction.....	99.2%
Cyanide consumption—11 lb. KCN per ton of concentrate.	

Results such as this led to a trial in which the object was to determine how much gold could be recovered in the quench solution when an effort was made in that direction. It was found that 94 per cent of the gold in a 1.92 oz. concentrate could be extracted in this way without the use of cyanide at all.

It is known that gold forms soluble sulpharsenate and polysulphide compounds and it is believed that the gold was taken into the quench solution through such agency. It could be precipitated from the solution by gentle aeration, particularly in the presence of a trace of manganese salt. Such precipitates assayed from 30 to 40 oz. per ton in gold and the gold so precipitated was not readily soluble in cyanide solution. Incomplete analysis of one precipitate showed it to contain 50.0 per cent arsenic and 41.2 per cent sulphur.

Further laboratory studies in this direction were contemplated, but when the MacKay process was abandoned as a practical answer to the Beattie problem, more pressing studies replaced this line of attack.

During the latter part of 1935 and in 1936, various schemes for treatment of Beattie ore were investigated and of these the most promising turned out to be a roasting procedure of a conventional nature except that a prolonged roasting period at initially low temperatures was employed, and the calcine was ground exceedingly fine for the cyanidation step. These tests were conducted at the mine and verified and extended by similar tests at the Bureau of Mines laboratories in Ottawa. Whereas roasting tests without special attention to temperature control yielded calcines from which only 87 per cent of the gold could be extracted by cyanide, the special procedure permitted extraction up to 95 per cent from a 2.00 oz. concentrate. The procedure has been described in detail in a Bureau of Mines report(5) and in a Canadian patent to W. G. Hubler(17). It was on the basis of this procedure that the Beattie roasting plant was designed. It can be described briefly as an oxidizing roast requiring fully oxidizing conditions over an extended roasting period, preferably

6 to 7 hours, and an increasing temperature range as the roast progressed, reaching a maximum of 1,500° to 1,600°F. When the grade of flotation concentrate was lowered, including more of the refractory middling products, to better flotation recovery, the per cent cyanide extraction after roasting was lower than for treatment of the 2.00 oz. concentrate already noted. Thus for a 1.00 oz. concentrate, the cyanide extraction would be about 92 per cent. This, too, varied seasonally as mining operations were switched from open pit to underground, and, as mining continued, more and more of the most refractory types of ore were encountered. Operation of the roasting plant for the first 18 months was based on this procedure, but during this time it became evident from laboratory studies that real advantages could be gained by adopting, as a guide to plant operation, the procedure already described in published papers (1,2). The operating aspects are dealt with more fully in a later section of this paper. At this point, the laboratory procedure is reviewed.

The type of laboratory apparatus used has already been described(1). The important factors requiring control are temperature, roasting atmosphere, circulation of gases, and efficient rabbling. It is important to use sufficient weight of charge to supply the necessary reducing atmosphere without restriction of gas circulation. The operation of roasting arsenopyrite concentrate, according to what may be termed the 'Beattie roast', consists of four steps, as follows: (1) *Pre-heating*.—This should be accomplished as rapidly as possible, and preferably in a reducing atmosphere, to avoid formation of arsenates; (2) *Arsenic elimination*.—It is important in this step to maintain the reducing atmosphere with as high a concentration of SO₂ as possible. It is equally important to have the fuming proceed as rapidly as possible in keeping with the ability to dissipate the heat and gaseous products. Vigorous rabbling, or lifting and sifting the charge through the furnace atmosphere, in a manner similar to the dropping from hearth to hearth in a multiple-hearth roaster, aids in the operation; (3) *Complete oxidation*.—The end point of step (2) is observable by a sharp reduction in visible arsenic fume given off. The roast should be continued until the charge ceases to glow when rabbled; (4) *Cooling*.—The roasted charge should be allowed to cool in the furnace to a temperature suitable for quenching. With some concentrates it is

important that this cooling step be accomplished gradually, for reasons probably related to oxidation of iron compounds.

The description just given seems to fit the requirements for roasting arsenical concentrates generally. No mention has been made of temperature ranges, and it is in this particular that variations may be required from one type of mineral combination to another. The type of time-temperature curve developed as most satisfactory for Beattie concentrate seems applicable to cases in which there is a high proportion of pyrite to arsenopyrite. In these cases, the decomposition of pyrite appears to speed the elimination of arsenic and promote it at a much lower temperature than is the case with materials predominantly arsenopyrite. Indeed, it is a requirement for a satisfactory roast on Beattie concentrate that the temperature be kept low (about 900°F.) during the period of arsenic elimination. Not only does the sulphur from pyrite serve as a source of heat, and as a reducing agent, but the volume of gas generated from it within the charge serves to sweep out the volatile arsenic compounds somewhat in the manner of zinc distillation in carbon monoxide from zinc oxide-carbon mixtures.

It is not unexpected to find that concentrate composed largely of arsenopyrite with a minor content of pyrite requires a higher roasting temperature for arsenic elimination. The principles relating to reducing furnace atmosphere, circulation of gas, and rabbling of the charge, are considered as applicable as in other cases.

A time-temperature curve, illustrative of the roast most satisfactory for Beattie concentrate is shown in Figure 1. The relative time intervals and total time will vary somewhat with the weight of charge, analysis of concentrate, and furnace characteristics. The end-points of steps 2 and 3 should be determined by observation of the progress of the roast rather than adherence to a time schedule.

Detailed results of tests on Beattie concentrate, and on concentrate from the Hard Rock gold mine, following the procedure just described, were given in the paper already cited(1). For completeness in this discussion, the results of three representative tests are given in Tables IA and IB. In test A, high-grade Beattie concentrate was used; in B, representative 1.00 oz. Beattie concentrate; and in C, Hard Rock bulk concentrate.

TABLE IA.—CHEMICAL DATA

	Fe%	S%	As%
A.—Concentrate.....	41.40	45.95	1.65
Calcine.....	57.40	0.048	0.73
B.—Concentrate.....	16.90	16.14	2.21
Calcine.....	18.80	1.55	0.34
C.—Concentrate.....	38.50	35.20	8.40
Calcine.....	57.20	0.165	0.67

TABLE IB.—ASSAYS AND RECOVERY

	AU ASSAY, oz./ton			% RECOVERY BY CYANIDAT'N
	CONC'TE	CALCINE	RESIDUE	
A...	2.30	3.00	0.12	96.3
B...	1.00	1.11	0.07	93.7
C...	1.44	2.16*	0.15	93.0

*Calculated on basis of iron analysis, concentrate and calcine.

Recent studies at the laboratories of Nepheline Products, Ltd., Lakefield, Ontario, and at the Bureau of Mines, Ottawa, have shown that, for roasting a concentrate with a low ratio of sulphur to arsenic (principally arsenopyrite), a temperature of 1,200° to 1,250°F. is required through the stage of arsenic elimination, following which the temperature may be held at that level until the roast is completed, or may be lowered to 900°F. for the oxidation step. It is expected that these studies

will be fully reported in due course by the investigators concerned. The author is indebted to the Lakefield laboratory for permission to include the data in Table II for purposes of present illustration. The concentrate used assayed 4.92 oz./ton in gold; 24.24 per cent Fe; 16.37 per cent S; and 16.28 per cent As. The procedure in test A was to put the charge in the furnace at 1,250°F. and maintain this temperature through both the arsenic elimination and oxidation steps. In test B, the procedure was similar, except that the temperature was permitted to drop to 900°F. for the oxidation step following active arsenic fuming. In test C, the Beattie roasting procedure, as illustrated in Figure 1, was used. In all cases, reducing conditions were maintained for arsenic elimination by regulation of draft and furnace-door opening, and the roast was finished under oxidizing conditions.

In laboratory tests, the pre-heating stage can be greatly shortened by manipulation of the furnace, but it is considered wiser to adjust the rate of pre-heating to suit the practical limitations of a plant furnace. If it is critical for a specific ore that the pre-heating be done rapidly, special provision for so doing will be required in engineering the plant.

It has been emphasized that a primary consideration in roasting arsenical ores is control of the furnace atmosphere to suit the needs of the successive steps, and that the most desirable time - temperature

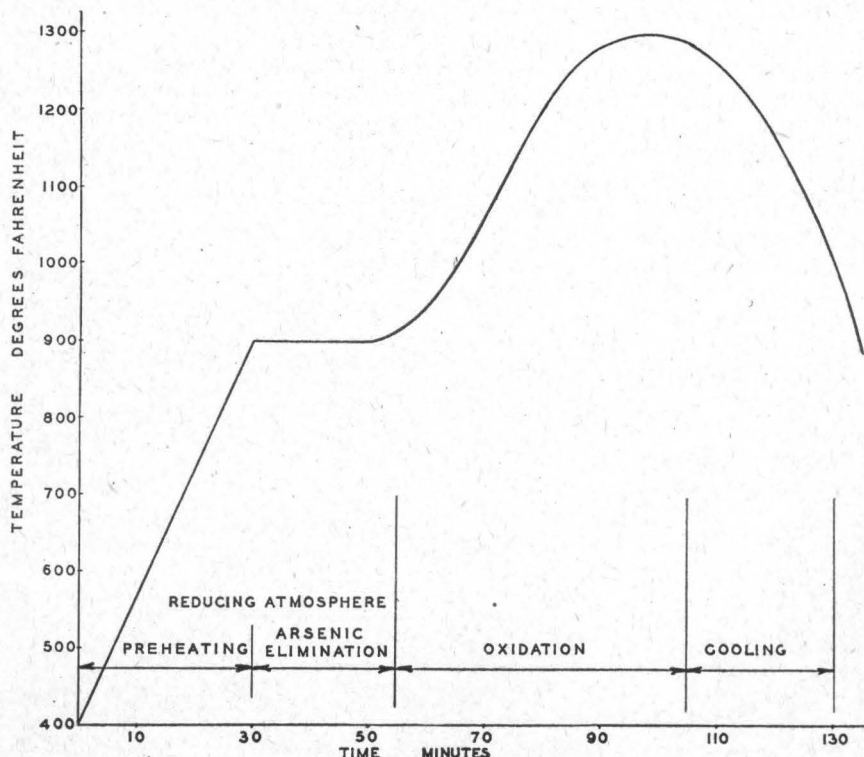

Figure 1.—Time-temperature curve, Beattie roast.

TABLE II.—ROASTING CONCENTRATE WITH LOW S/AS RATIO

TEST NO.	ASSAYS OF CALCINE				RESIDUE Au, oz./ton	% GOLD RECOVERY BY CYANIDATION
	Au, oz./ton	Fe, %	S, %	As, %		
A.....	6.18	30.46	0.12	0.75	0.233	96.20
B.....	6.14	30.23	0.15	0.75	0.23	96.25
C.....	6.21	30.58	0.13	1.09	0.33	94.68

curve will assume a shape characteristic of the particular ore or concentrate, and is dependent on its mineral composition. A brief study of the chemical reactions and principles involved is now presented to show how the differences in behaviour and requirements from one ore to another may arise.

Arsenopyrite (FeAsS) has been reported to dissociate slightly at temperatures as low as 220°C. and arsenic has been manufactured by distillation of arsenopyrite or lollingite, out of contact with air, at 650° to 700°C. Apparently, the vapour pressure of arsenic and diffusion in the gaseous phase are controlling factors.

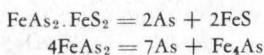

Vapour pressure constants for arsenic, in the temperature range now considered, are given as $A' = 6,950$ and $B' = 10,800$ (18), employing the approximate equation,

$$\log p = -\frac{A'}{T} + B'$$

The minimum distillation temperature at atmospheric pressure would be expected to be 605°C. (1,121°F.).

Assuming that the mechanism of the roast according to the procedure described involves the reactions given, followed by oxidation to arsenious oxide, $4\text{As} + 3\text{O}_2 = \text{As}_4\text{O}_6$, the necessity for a furnace temperature of 1,200°F. in the case of nearly pure arsenopyrite is clear. Such a mechanism has not been proven, but the somewhat similar reactions in zinc metallurgy are well-known.

Consider now that an inert, or reducing, gas such as sulphur vapour or SO_2 is evolved simultaneously from the charge, or circulated through it so that the volume concentration of arsenic vapour is reduced to one-twentieth of the total vapour in contact with the arsenopyrite, then the minimum temperature for distillation of arsenic will be 481°C. (898°F.). Such a reduction in the case of representative Beattie concentrate carrying 16 per cent S

and 2.4 per cent As would be accomplished by utilization of about one-third of the total sulphur content for dilution.

The shape of the time-temperature curve shown in Figure 1 for roasting Beattie concentrate fits reasonably with this interpretation, adding the further expected effect that, as the bulk of the arsenic is volatilized, and the vapour pressure remaining becomes low, it will be necessary to increase the temperature to a final value considerably in excess of 1,121°F.

It is evident that oxidizing conditions during the early part of the roast, forming ferric arsenate surfaces, will retard or prevent the volatilization at low temperatures.

It would be expected that an addition of pulverized coal or coke toward the end of the arsenic elimination step might aid in its completion by reducing arsenates and providing a gaseous carrier. This was found to be the case, although the advantage gained was not great enough to offset the cost of coal and its preparation.

The use of common salt was investigated from time to time and a great many variations in its treatment were tried. A survey of all the data shows that the use of salt is a tricky business, that results are inconsistent in spite of efforts to standardize other conditions, and that losses in fume when salt is used are likely to offset any improvement in percentage cyanide extraction from the calcine. Many other devices were tried in the laboratory but none of them gave promise of practical advantage as great as the following of the principles already

set out with respect to gas concentration and temperature control.

Some of the chemical reactions involved in roasting ores of the type under consideration are set out here for reference in the ensuing discussions.

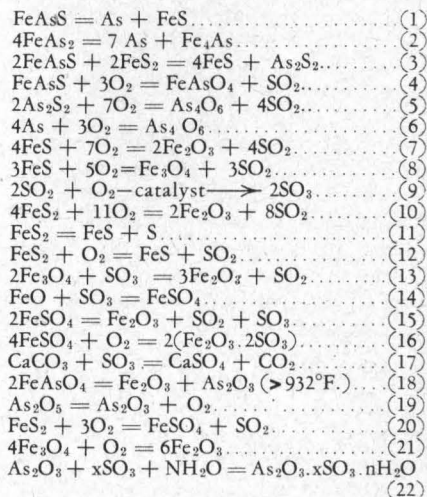

The first twelve are considered the most important and desirable reactions.

For clean concentrates carrying a small proportion of slimes and free from other interfering elements, the behaviour on roasting can be fairly well explained on the basis of these equations and the principles outlined. However, there are factors, still unexplained, that contributed to the refractory behaviour of Beattie concentrate. Using identical laboratory test conditions and technique, variations in cyanide extraction from calcines of 2 per cent or more were observed from one sample to another taken at different times, particularly as mining operations changed seasonally from open pit to underground, or from one part of the mine to another.

The set of tests for which data are given in Tables III and IV illustrate this fact as well as showing the effect of variations in rabbling technique and temperature curve. In the first set of tests (Table III), roaster feed for June 3rd, 1944, was used, assaying 0.84 oz./ton gold; 15.16 per cent Fe, 14.25 per cent S, and 0.79 per cent As. In test A, the

TABLE III.—ROASTING TEST DATA

TEST NO.	CALCINE ASSAY				RESIDUE Au, oz./ton	% CYANIDE EXTRACTION
	Au, oz./ton	Fe, %	S, %	As, %		
A.....	0.94	17.01	1.94	0.30	0.13	86.20
B.....	0.95	17.18	1.26	0.34	0.07	92.65
C.....	0.95	17.09	1.50	0.38	0.055	94.19

TABLE IV.—ROASTING TEST DATA

TEST No.	CALCINE ASSAY				RESIDUE Au, oz./ton	% CYANIDE EXTRACTION
	Au, oz./ton	Fe, %	S, %	As, %		
A.....	1.10	18.09	1.26	0.30	0.12	89.12
B.....	1.09	17.87	1.12	0.30	0.09	91.74
C.....	1.08	17.76	1.31	0.30	0.085	92.15

charge was rabbled briefly at half-minute intervals; in *B* it was rabbled continuously and vigorously; and in both *A* and *B* the temperature curve followed the current roaster plant curves. In test *C*, the standard laboratory temperature curve was followed, differing chiefly from *A* and *B* in that the curve was more flattened during the period of arsenic fuming. As will be brought out later, under the section on plant operation, operating limitations made it impossible to adhere strictly to the laboratory curve.

In the set of tests for which data are given in Table IV, the head samples was taken from the roaster feed for June 27th, 1944, and assayed 0.94 oz./ton gold; 15.41 per cent Fe; 14.38 per cent S; and 1.20 per cent As. In test *A*, the charge was rabbled at half-minute intervals; in test *B* at half-minute intervals with lifting and dropping the charge to simulate the drop between roaster hearths; and in *C*, the standard laboratory procedure was followed.

Studies aimed at identification of refractory elements in Beattie ore were reported in an earlier paper(1). It was shown then that, in addition to such behaviour attributable to arsenic, there were elements related to slime components, to those components relatively high in iron with reference to the sulphide content, and to those components with a high ratio of silver to gold.

These studies were continued after publication of the paper, but in the main the results merely added confirmation to findings already reported. Present discussion is limited to three points:

(1) It was shown that the finely disseminated sulphides characteristic

of Beattie flotation middlings exhibited particularly refractory behaviour for reasons difficult to assess. In chemical composition, the sulphides in this material approach that of a mixture of pyrrhotite and arsenopyrite, and the gold content is so finely disseminated as to be sub-microscopic and may be of colloidal or even atomic dimensions. This cannot be stated with certainty on the basis of available data, but such evidence as could be gained with the tools available lends support to the colloidal theory with respect to the association of most of the unavailable gold with iron compounds, before, during, and after roasting. It has been demonstrated that fine grinding of calcine beyond 90 per cent minus 375 mesh does not result in increased cyanide extraction. Norwood(13) has reported studies and an interpretation that points to inclusion of sub-microscopic gold in iron oxide structures. His evidence, however, is not of the positive kind that might have been shown by X-ray methods and other tools now available for structural studies, although not likely to be found in gold mine laboratories. The extreme refractory character of the finely disseminated minerals in a 'middling' concentrate fraction selected from the Beattie flotation plant is shown in Table V.

(2) It was also shown in the earlier paper(1) that siliceous gangue slimes reduced the effectiveness of roasting. Whether this is due to smothering, to catalysis of undesirable reactions, to actual combination with or adsorption of gold, or to a combination of these has not been proven. It was shown that a particular rock formation in the

mine designated 'bleached breccia', and from which variable tonnages were included with the ore, contributed especially to the flotation plant slime problem and roasting plant dust problem. Further laboratory studies on the influence of multiclone and hot Cottrell dust returned to the roasters showed that the extractability of gold was lowered on the average, 1.28 per cent if the dust (15 per cent of the weight of charge) were added after the arsenic elimination period (1,080°F.); 4.40 per cent if added just prior to this step (850°F.); and 3.36 per cent if added to the cold charges before roasting. Addition of cold Cottrell dust (crude white arsenic) to concentrate before roasting, up to 5 per cent of the weight of charge, had only a slight harmful effect on gold recovery.

Hot Cottrell dust contained partially roasted sulphides and an appreciable concentration of iron relative to roaster feed. The sample used in the tests to which reference is made contained 23.32 per cent Fe, 4.38 per cent S, and 1.52 per cent As. When roasted alone, cyanide extraction from the resulting calcine was 85.3 per cent.

(3) From the studies in which Beattie concentrate was separated into fractions showing varying degrees of refractory behaviour(1), and evidence that at least occasional particles of electrum were to be found in Beattie cyanide residue(19), it was suspected that gold-silver alloys, rich in silver, might be responsible for resistance to cyanidation. Such alloys would also be expected to be more susceptible to surface contamination with arsenate compounds, and more likely to contain alloyed arsenic. A photomicrograph of Beattie residue showing a particle identified as electrum is shown in Figure 2. A much smaller particle (about 1 micron diameter) is shown enclosed in hematite in Figure 3.

Considerable study and experiment were directed toward further light on this aspect, but the evidence indicates that the presence of precious-metal particles of size observable under the microscope is only occasional and could account for only a small fraction of the residual gold in Beattie calcines after cyanidation. Moreover, it was found that synthetic gold-silver alloys of the composition indicated by Beattie ore product assays were readily dissolved in cyanide solution; and that gold-silver-arsenic alloys dissolved much more rapidly than arsenic-free alloys.

TABLE V.—DATA ON REFRACTORY MIDDLING CONCENTRATE

	ASSAYS				BY CYANIDATION	
	Au, oz./ton	Fe, %	S, %	As, %	RESIDUE (oz.)	% EXTRACTION
Middling concentrate.....	0.26	10.5	6.47	3.52	0.18	30.8
After roasting.....	0.29	11.8	0.99	1.97	0.10	65.5

This and the fact that intensive ball-milling of calcine does not aid extraction beyond the point already noted argue against refractory behaviour being due to arsenic-containing gold alloys, or to gold surfaces contaminated with arsenic. This theory is frequently propounded—as recently as 1941 by Russian authors(20)—but the evidence for it is considered inconclusive.

Since no literature has appeared on the solubility of gold-silver-arsenic alloys in cyanide solution, the results of studies made by the staff of Nepheline Products, Ltd., in co-operation with the author are summarized here.

The system Au-As was studied by A. P. Schleicher(21) and his method of making the alloys was followed. The alloying metals employed were proof gold (999.9 fine) obtained from

the Royal Canadian Mint, Ottawa; 'C.P.' silver foil; and purified granulated arsenic. In the first set of tests, alloys of the compositions shown in Table VI, A to D, were used.

TABLE VI.—COMPOSITION OF ALLOYS

ALLOY	PERCENTAGE COMPOSITION		
	GOLD	SILVER	ARSENIC
A.....	Proof	0	0
B.....	93.82	6.17	0
C.....	86.72	12.49	0.73
D.....	83.72	13.69	2.59
E.....	37.50	36.51	25.99
F.....	49.58	48.77	0

One-gram beads of each alloy were given successive treatments in dilute cyanide solution. In each case the relative solubilities after a given

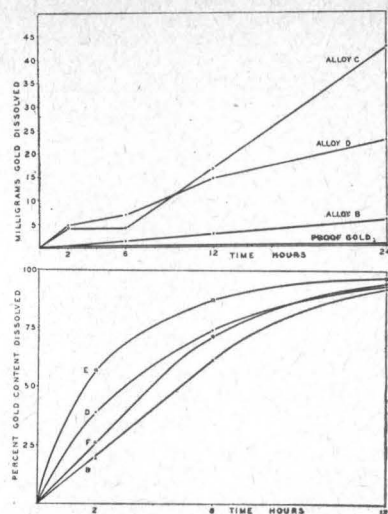

Figures 4 and 5.—Rates of dissolution of some gold alloys.

(Top) Beads
(Bottom) Filings

period of agitation showed the same trends as shown in Figure 4.

For a second set of tests, two additional alloys were prepared of composition shown under E and F in Table VI. In this case, the alloys were reduced to minus 100 mesh filings before cyanidation, and 0.5 gram samples were agitated with 0.10 per cent cyanide solution containing 0.0025 per cent CaO for protective alkalinity. The results are shown in Figure 5.

It was concluded from these tests that arsenic, alloyed with gold-silver alloys, aids rather than hinders dissolution of gold in cyanide solution and that such could be ruled out as a cause of refractory behaviour of gold-bearing arsenical ores. The presence of particles of precious metal in cyanide residues remains unexplained.

A subject that has not been touched in this discussion is that of sulphate formation and its effect on roasting and the nature of the roasted product. Considerable sulphating occurred in the Beattie roasters and attempts were made to trace its progress and estimate its importance. The oxidation of pyrite is a complicated process, if intermediate reactions are considered, and aside from noting that formation and decomposition of ferrous and ferric sulphates, and the presence of calcium sulphate, are of unassessed importance, the subject is not enlarged upon through lack of clear-cut results. The amount of sulphate in final roaster products is shown later under the section on roaster heat balance.

Informative studies on the decomposition of pyrite have been reported by Gill(22) and by Schwab and

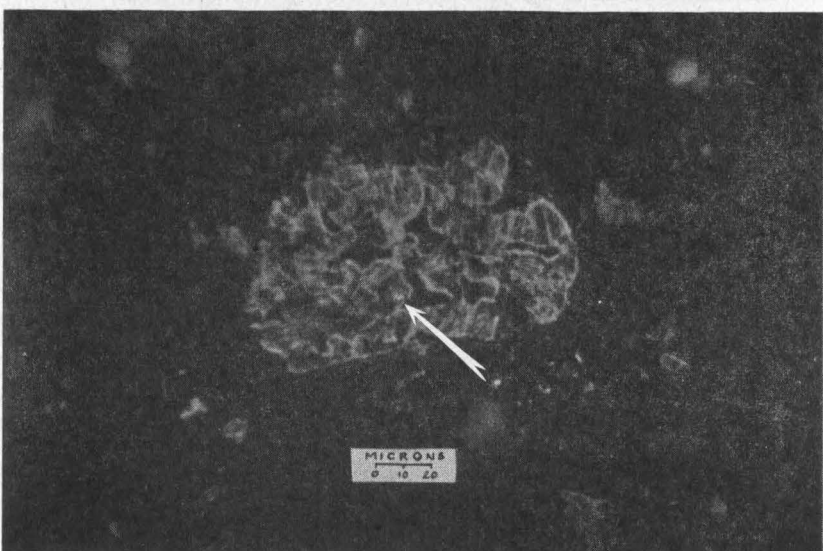
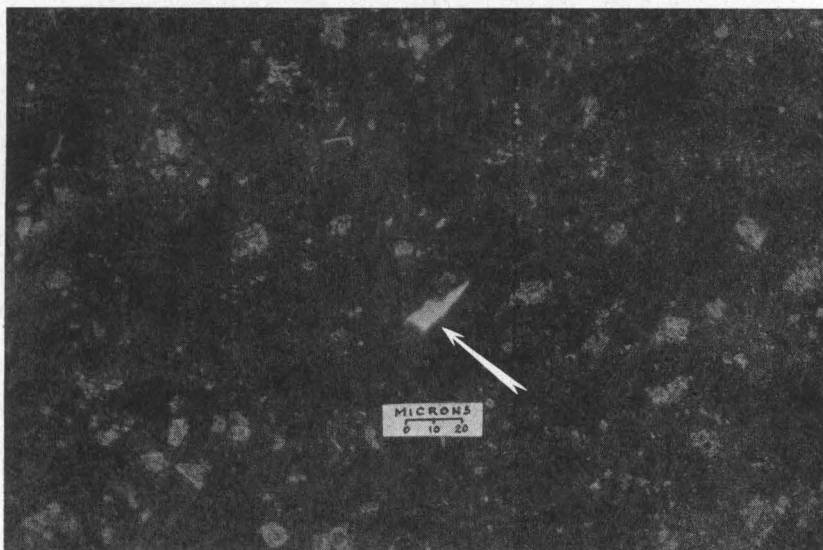

(Courtesy American Cyanamid Co.)

(Top) Figure 2.—A metallic particle identified as electrum in Beattie cyanide residue. $\times 700$

(Bottom) Figure 3.—A metallic particle of electrum enclosed in hematite from Beattie cyanide residue. $\times 700$

Philinis(23). The latter authors conclude that the oxidation rate is determined, not by a chemical process, but by the rate of diffusion of the gas phase, and that the formation of sulphate tends to close the pores in the ferric oxide produced, thereby stopping the reaction short of completion. This may well be the sort of action that results from formation of ferric arsenate when arsenopyrite is roasted under oxidizing conditions at low temperatures. Non-porosity of calcines has heretofore, been variously attributed, usually to fusion through flash roasting at excessive temperatures, or to recrystallization of ferric oxide.

Reduced to practical terms, and accepting a few basic chemical reactions that should proceed in sequence, adequate preparation of the ore or concentrate, and adequate mechanical devices to move and turn the charge and regulate air and gas flow, good roasting, then, depends on manipulation of the variables *time, temperature, concentration, and catalysis*. Any one of these variables may be limited by design of equipment to something less than optimum. Little has been said about catalysis. It applies particularly to the oxidation of SO₂ and As₂O₃ and, except for attention to dust loads and point of dust return to the roaster, is not subject to control.

Attention is now turned to the Beattie roasting plant, with particular attention to data and discussion relating to manipulation and control as just defined.

THE BEATTIE ROASTING PLANT

A simplified flow-sheet for the Beattie plant is shown in Figure 6. Since control of the roasting operation started through control of the flotation operation, the flow-sheet of the latter is included.

The original Beattie flotation plant, designed for making a concentrate of maximum grade for shipping, included a middling concentrate re-grind circuit not shown on the diagram. This operation was discontinued in order to reduce dust

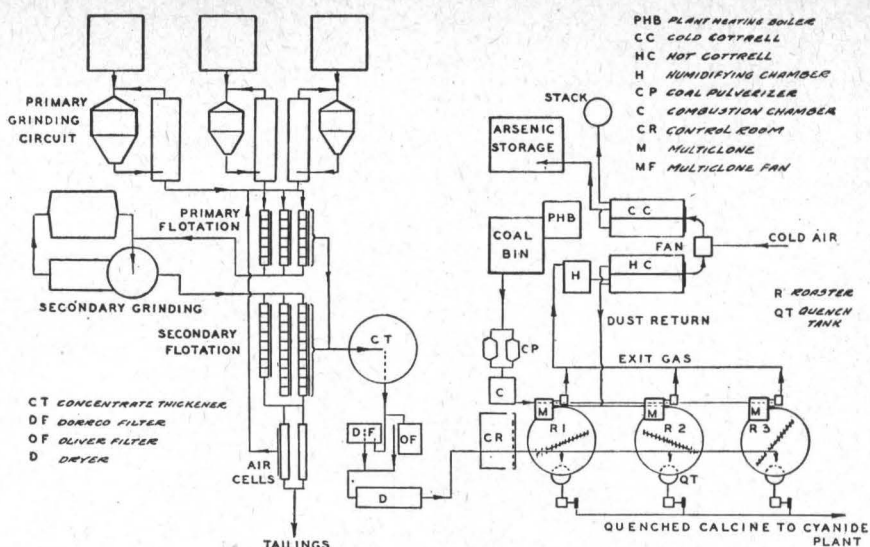

Figure 6.—Flow-sheet of flotation and roasting plants.

forming slimes in the concentrate. As the needs of the roaster operation developed, the flotation operation was conducted with the objects of (1) maximum gold recovery, (2) minimum flotation of gangue slimes, and (3) a constant sulphur content in concentrate. It was found that, as the sulphide content of the ore fluctuated, it was preferable for roaster control that the tonnage of concentrate be varied than that the percentage sulphur vary. Rapid sulphur determinations were made on mill feed and concentrate several times on each shift, and the results were made available to the flotation operators as a guide whereby the constant percentage sulphur content in concentrate was maintained. Seasonal adjustments were necessary to suit changes in ore type, but ordinarily a grade of 15 to 16 per cent sulphur was satisfactory for both flotation and roasting operations. The daily milling rate during the period used for illustration was approximately 1,800 tons of ore assaying 0.13 to 0.14 oz. gold per ton. Flotation recovery averaged 87 to 88 per cent, yielding 200 to 250 tons of concentrate varying from 0.80 to 1.00 oz. gold per ton. Analytical data from the records for early 1940 are shown in Table VII and typical

particle size distribution of concentrate (roaster feed), as determined by a Haultain infrasizer, is shown in Table VIII.

TABLE VIII.—PARTICLE SIZE DISTRIBUTION, BEATTIE CONCENTRATE

MICRON SIZE	% WT.	ASSAY Au, oz./ton
+ 100 mesh.....	20.6	0.64
56μ - 100 mesh.....	30.6	0.88
40 - 56μ.....	7.8	0.90
20 - 40μ.....	13.4	1.15
10 - 20μ.....	9.0	1.50
- 10μ.....	18.6	0.86

After thickening, filtering, and drying in a Ruggles-Coles dryer to 8 to 10 per cent moisture, the concentrate was conveyed to roaster feed bins of 250 tons capacity over each roaster. The rate of feed from the bins to the dryer hearth was regulated by variable speed and bed depth on 42-inch-wide belt feeders, two for each roaster.

There were three 25-foot-diameter Wedge-type furnaces, each with 13 hearths and a dryer hearth, in the installation but, except for the first eighteen months of operation, two roasters handled the total tonnage. The furnace design is conventional except that more than usual insulation was provided. Each of the three roasters was lined with a different make of refractory brick, giving 9-inch thickness in each case. In one roaster, Therm-O-Flake insulation was used between shell and brickwork and, in the others, Silocel. The three installations gave trouble-free service. The general design is illustrated in Figure 7. The hearth area of each roaster was approximately 4,500 sq. ft.

TABLE VII.—ANALYTICAL DATA

	Au, oz./ton	Fe, %	S, %	As, %	SCREEN SIZE	
					+100 mesh	-325 mesh
Original ore.....	0.13	4.6	2.20	0.35		
Concentrate.....	0.90	16.7	16.00	2.30	19.0	48.4
Roaster calcine.....	1.123	20.0	1.56*	0.30		

*1.25 per cent water-soluble sulphur included.

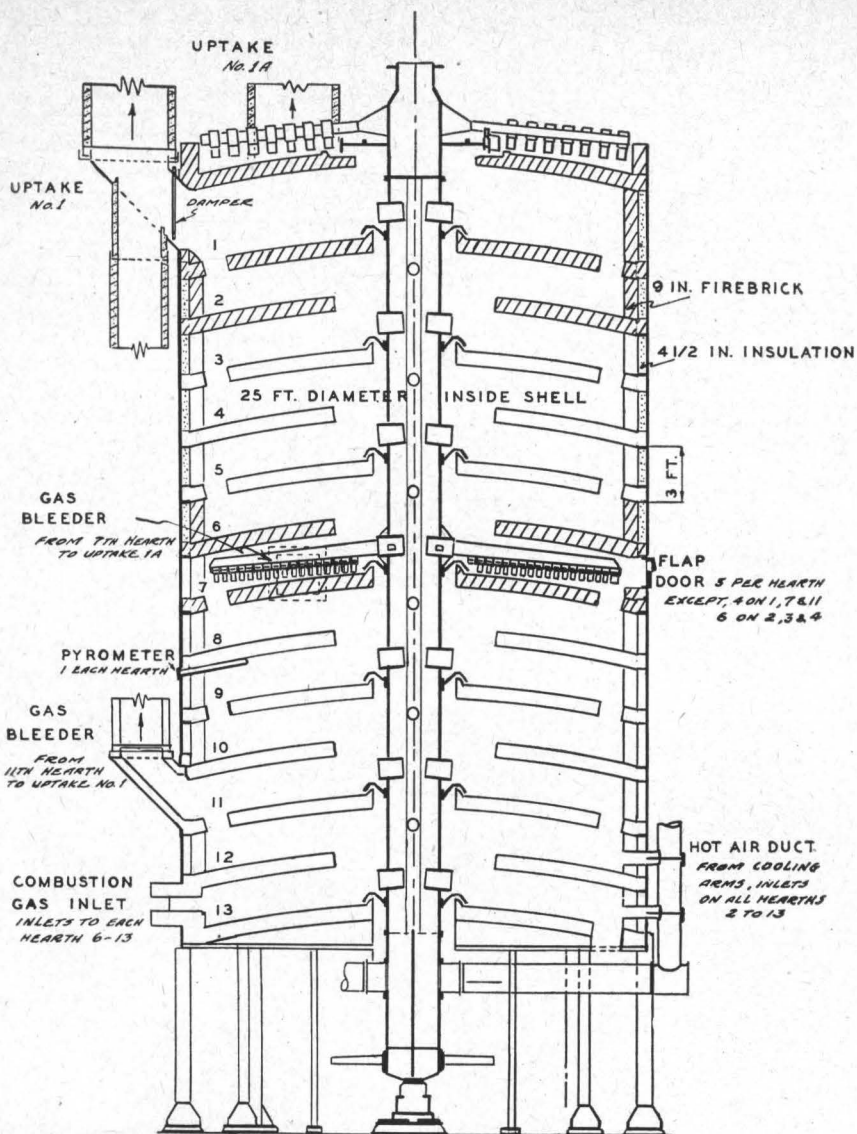

Figure 7.—Diagrammatic section, Wedge roaster.

A coal pulverizing unit, combustion chamber, and riser flues to provide heat up to the 6th hearth were provided and used for a time at the start of roasting operations, but the need for extraneous fuel was eliminated when the total feed tonnage was handled in two roasters.

Each roaster was provided with gas bleeder flues from hearths 7 and 11, and two uptake flues from hearth 1. These flues joined to enter a multiclone dust collector at the top of each roaster, and these collectors, in turn, each discharged through a fan to a common balloon flue. The flues were all brick lined.

The balloon flue discharged into a humidifying chamber, which in turn discharged into the hot Cottrell unit. The discharge flue from the latter led to a fan, the inlet of which was provided with an automatically controlled louvre damper and flue to admit cooling air from outside the plant. The hot Cottrell gases and atmospheric air were mixed by the

fan and the mixture so regulated that the temperature was maintained at 250°F. in order to ensure efficient condensation and precipitation of arsenious oxide in the cold Cottrell unit following. The hot and cold Cottrell units each consisted of two sections, each section carrying 14 rod curtains (13 ducts), 12 feet long.

The cold Cottrell discharged through a flue to the 400-foot, brick-lined, reinforced concrete stack, 18½ feet diameter at the bottom tapering to 7 feet diameter at the top, inside dimensions.

Dust from the multiclone collectors returned to the 6th hearth by gravity. The dust from the hot Cottrell was collected from the Cottrell hoppers by drag conveyors and elevated to return through a splitter to the sixth hearths of the two roasters used.

The calcine discharged from the 13th hearth of each roaster into a covered quench tank with agitator.

The water-quenched calcine overflowed to a pump sump and was pumped to the cyanide plant, there to be ground to 90 to 95 per cent minus 325 mesh, thickened, filtered, and cyanided in the usual way.

The roaster shafts and rabble arms were air-cooled and, although provision was made for use of the heated air from this source in the roasters, it was not needed and was wasted. The shaft carried two rabble arms per hearth and made approximately one revolution per minute. Special plow blades were used for the dryer hearth rables and high-chromium cast-iron blades on the hot hearths.

The control room was well equipped with indicating and recording instruments for hearth and flue temperatures, drafts, and SO₂ measurement.

The roaster building was normally free from dust and roaster gases, and accumulations were prevented by regular use of a vacuum cleaner.

Operation and Control

The first element in roaster control has already been noted by reference to the flotation operation, and particularly the maintenance of a constant percent sulphur content in the roaster feed. The drying and feeding of concentrate has also been noted. Little trouble was met with on account of stickiness or packing, although the dryer hearth beds required occasional digging up with a pneumatic spade.

Temperature, draft, and air inlet control are interdependent and these were the chief manipulative controls required of the operators. The draft balance varied seasonally and with the tonnage, but for average conditions the static draft graded from 0.6 inches of water at the stack to 0.25 inches or lower at the roaster flue outlets. The relative gas volumes drawn through the uptakes on hearth 1 and the bleeders from hearths 7 and 11 were regulated by dampers to keep the roaster temperatures in balance. The uptakes were normally wide open and 60 to 70 per cent of the total gas volume was drawn through them. Number 4 hearth was considered the key hearth in controlling the temperatures and it was maintained as nearly constant as possible for a given tonnage rate. If a roaster showed a tendency to heat up at the top, the bleeder on hearth 11 was opened wider and, if necessary to re-establish a balance, the up-draft in it was boosted temporarily by means of an air jet. Hearth 10 was normally the hottest hearth (gas temperature about 1,300°F.), and the charge

cooled to 600° to 800°F. on hearth 13 before discharging to the quench tank.

Air was admitted to the roasters by opening sight flaps and doors as required to maintain the temperatures and complete the roast. There were five doors, with flaps, on each hearth, but normally nearly all the air was admitted on hearths 7 and 8. A certain amount of air was drawn in through the discharge openings on hearth 13.

Typical hearth temperatures (1940) are shown graphically in Figure 8. The upper and lower branches of the curve show the nature and extent of variations due to fluctuations in feed rate and operating conditions.

It will be seen that this curve differs somewhat in shape from that found most desirable in laboratory tests (Figure 1). It was not possible in plant operation to accomplish much flattening of the curve at 850° to 950°F., but the closer we could bring the plant curve to the shape shown in Figure 1, the better were the results.

A summary of data taken from the record for May, 1940, is given below. These data are also used for calculation of the heat balance, shown in Table IX.

(1) Daily average tonnage to each roaster, 114.25 tons.

(2) Analysis of feed (dry basis):

Moisture.....	8.00 per cent
Fe.....	15.81 "
S.....	15.3 "
As.....	2.6 "

For calculation, it is assumed that the sulphide content was made up of 23.6 per cent FeS₂, 4.46 per cent FeS, and 5.65 per cent FeAsS. The remainder of the material consisted of quartz, feldspar, and calcite gangue.

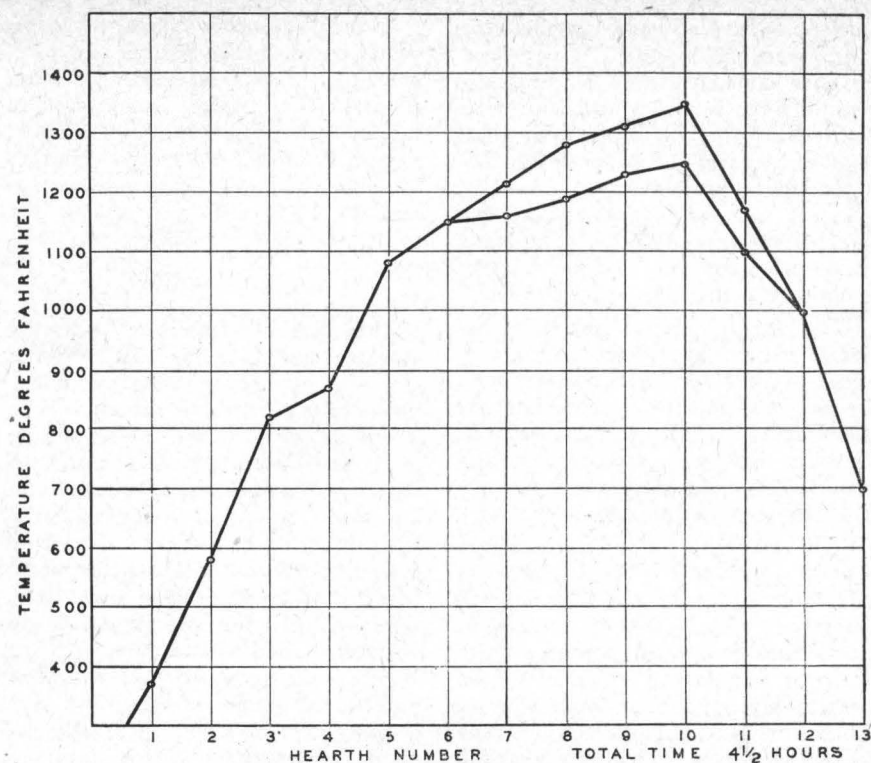

Figure 8.—Typical gas temperatures over hearths.

(3) Gas volumes (one roaster):

- (a) Cooling air (arms), 4,980 c.f.m., in at 25°C. and out at 147°C.
- (b) Furnace flue gas, 25,000 c.f.m. at 282°C. and 736 mm.

(8) About 300 lb. oily flotation reagents per roaster per day. Calorific value assumed to be 7,500 cal. per gram.

(4) Analysis of calcine:

Total S.....	1.90 per cent (hearth 13)
Insoluble S.....	0.36 "
Sulphide S.....	<0.10 "
Arsenic.....	0.33 "

(9) Of the 9.15 tons water in feed to 1 roaster, 7.15 tons entered roaster and 2.0 tons evaporated on dryer hearth.

(5) Weight reduction, 18.13 per cent.

(6) Final calcine temperature (hearth 13), 338°C.

(7) SO₃ produced per roaster required oxidation of 4.20 tons SO₂. (SO₃ found in calcine, cold Cottrell dust, and stack).

The reactions considered were as follows:

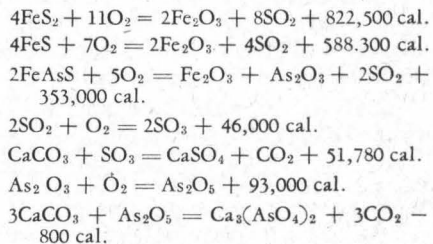

The heat of combustion of FeAsS was computed from data supplied by the Bureau of Mines, Ottawa.

For simplicity in calculation, the heat unit used in Table IX is a ton-calorie per ton, and reference temperature is 25°C.

During the same period (May, 1940), which is selected as being typical, roaster plant data were gathered with particular care and completeness. Some of the more informative facts are now summarized.

SO₂ concentration in the gas over hearth 5 averaged 3.74 per cent in one roaster and 4.42 per cent in the

TABLE IX.—HEAT BALANCE (ONE ROASTER)

HEAT IN		HEAT OUT		
	TONS/24 HR.	TON-CALS.	TON-CALS.	
Burning FeS ₂	26.96	46,200	Air, As ₂ O ₃ , and CO ₂	41,700
FeS.....	5.10	8,500	Water.....	6,210
FeAsS.....	6.45	6,980	SO ₂ and SO ₃	1,270
Oxidation SO ₂	4.20	1,510	Calcine.....	6,080
Reaction SO ₃ with CaCO ₃ ..	5.35	2,880	Cooling air.....	7,530
Oxidation As ₂ O ₃	0.44	210	Radiation (diff.).....	4,610
Burning reagents.....	0.15	1,120		
TOTAL.....		67,400	TOTAL.....	67,400

other, and over hearth 10 the averages were 2.23 and 2.70 per cent. Higher concentrations on hearth 5 would have been desirable but were limited by factors imposed by location of bleeders and other design and operating requirements. Average cyanide extraction for the month was 91.76 per cent in the plant and 92.5 per cent on calcine samples cyanided in the laboratory.

The average daily dust tonnages were 15.38 tons from the multiclones (total for both roaster units operating), and 15.4 tons from the hot Cottrell. This represents a total dust load of 13.4 per cent of the dry feed. The time of passage through the roasters was $4\frac{1}{2}$ hours.

The average stack volume was 93,000 c.f.m. at 236°F. The amount of water added to the humidifying chamber varied with atmospheric conditions but was ordinarily 8 to 10 tons per day. The addition of water improved dust collection in both hot and cold Cottrells. Stack loss of gold was negligible (less than 0.05 per cent of the gold in roaster heads).

The grade of crude arsenious oxide collected in the cold Cottrell was normally within the range 76 to 85 per cent As_2O_3 , averaging 78.3 per cent for the month for which the other data have been given. Of the remaining components, SO_3 made up 6 to 8 per cent, H_2O 4 to 5 per cent, and Fe_2O_3 2.5 to 3.5 per cent. Gold assays averaged 0.15 oz. per ton, involving a loss in cold Cottrell dust of less than 0.5 per cent of the gold in roaster heads. Later improvements in hot dust collection reduced the total loss of gold in crude arsenic and stack to less than 0.25 per cent.

Analysis of multiclone and hot-Cottrell dusts are shown in Table X.

TABLE X.—DUST ANALYSES

	MULTICLONE DUST	HOT COTTRELL DUST
Fe.....	33.52 per cent	26.92 per cent
S.....	3.46 "	4.47 "
As.....	1.23 "	2.22 "
Au.....	1.70 oz./ton	1.18 oz./ton
Wt., minus 10 microns.	43.40 per cent	90.97 per cent

Typical monthly average roaster plant costs in the period under review (1939-1940) were \$1.08 per ton of dry concentrate, made up of labour, 50 cents, supplies 20 cents, power 19 cents, and general charges 19 cents. This total cost was equivalent to 13.5 cents per ton of ore milled.

CONCLUSION

The general subject of roasting arsenical gold ores has been reviewed and the solution of the particular problem at the Beattie mine has been given in some detail. The picture is far short of perfection, from both theoretical and practical viewpoints, and there remain unanswered problems in both directions. Roasting tests in the Beattie laboratory numbered in the hundreds, but more fundamental studies in physical and structural chemistry are needed than are possible in even well equipped mining company laboratories. On the engineering side, there remains plenty of opportunity for improvement. Reference to the laboratory roasting curve (Figure 1) shows that half the roasting time obtaining in the plant operation should have been sufficient, and this points to the possibility of handling up to 250 tons of concentrate per day in one roaster of the size and type used at Beattie, provided the appropriate changes in speed and flue design were made. Although the multiple-hearth roasters at Beattie were satisfactory in performance, and in some respects remarkably so, improvement in design to give better control of gas concentration and temperature could well have added 1 to 2 per cent in gold recovery.

ACKNOWLEDGMENTS

Acknowledgment is gratefully made to W. B. Maxwell, General Manager of Beattie Gold Mines (Que.), Limited, during the author's association with that Company, to D. E. Hillier and Edmond Bonenfant, who were responsible for the later studies, and to B. D. Weaver, of Nepheline Products, Limited, all for co-operation in assembling data for this paper and for permission to publish it. Acknowledgment is made also to R. J. Traill, of the Bureau of Mines, Ottawa, for discussion and for arranging for the determination

of the heat of combustion of arsenopyrite.

REFERENCES

- (1) ARCHIBALD, F. R., MARTIN, F. J., and KOENEN, A. T., *Roasting of Beattie Concentrate*, C.I.M., Trans., **42**, 608-631 (1939).
- (2) ARCHIBALD, F. R., and HARRIS, W. A., *The Importance of Temperature, and of Sulphur Dioxide Concentration, in Roasting Arsenopyritic Concentrate*; C.I.M., Trans., **43**, 757-761 (1940).
- (3) HUBLER, W. G., and MARTIN, F. J., *Ore Treatment at Beattie Gold Mines, Ltd.*; A.I.M.E., Trans., **112**, 690-703 (1934).
- (4) DAVIDSON, Stanley, and BANFIELD, A. F., *Geology of the Beattie Gold Mine, Duparquet, Que.*; Econ. Geol., **39**, 535-56 (1944).
- (5) BUREAU OF MINES, CANADA, Report No. 776, *Ore Dressing and Metallurgical Investigation No. 696* (1936); *Roasting and Cyaniding Primary Concentrate from Beattie Gold Mines, Ltd.*; also Report No. 792 (1938), *Mill Products from Beattie Gold Mines, Ltd.*
- (6) DWIGHT, A. A., *Roasting and Sintering*; Riddell's Handbook of Nonferrous Metallurgy, 2nd Ed., 276-323 (1945).
- (7) HAYWARD, C. R., *An Outline of Metallurgical Practice*; Van Nostrand (1940).
- (8) VON BERNEWITZ, M. W., *Roasting Gold-Silver Sulphide Ores and Concentrates*, Parts I to V; Can. Min. Jour. (1940).
- (9) LEAVER, E. S., and WOOLF, J. A., U.S. Bur. Mines, Tech. Paper No. 423 (1928).
- (10) CLEVINGER, G. H., and CARON, M. H., *Treatment of Manganese-Silver Ores*; U.S. Bur. Mines, Bull. 226, p. 20 (1925).
- (11) BOUTON, C. M., RIDDELL, W. C., and DUSCHAK, L. H., *Silver in Chloride Volatilization*; U.S. Bur. Mines, Tech. Paper No. 317, p. 42 (1924).
- (12) HASZARD, N. I., *The Condition of Refractory Gold in Lake View and Star (Kalgoorlie) Ore*; Austr. I.M.M., Proc., No. 108, 253-324 (1937).
- (13) NORWOOD, A. F. B., *Roasting and Treatment of Auriferous Flotation Concentrate*; Austr. I.M.M., Proc., No. 116, 391-412 (1939).
- (14) WALKER, J. A., *Roasting and Cyanidation of Arsenopyrite Concentrates*; Chem. Eng. Mining Rev., **32**, 122-4 (1940).
- (15) MADSEN, C. H., *The Treatment of Refractory Ores at Hard Rock Gold Mine*; C.I.M., Trans., **44**, 203-12 (1941).
- (16) PALEN, A. G. Paul, *Boliden och Dess Arsenikproduktion* (1934).
- (17) HUBLER, W. G., Canadian Patent 375,016, July 12th, 1938.
- (18) BUTTS, Allison, *Metallurgical Problems*; McGraw-Hill (1943).
- (19) DAVIS, D. W., Amer. Cyanamid Co. Ore Dressing Lab. Rep't., Nov. 11th, 1938.
- (20) OGLODKOV, V. A., Sbornik Trudov. Irkutsk Gornó Met. Inst., 1940, No. 2 3-36; cf. C.A. **37**, 4037.
- (21) SCHLEICHER, A. P., Internat. Zeitsch. Metallographic, 1914, **6**, 1B.
- (22) GILL, A. F., Can. Jour. Research, **10**, 703 (1934).
- (23) SCHWAB, George-Maria, and PHILINIS, John, Amer. Chem. Soc., Jour., **69**, No. 11, 2588-2596 (1947).