

TUTORIAL ON COMPOSITE PUMPS

Frederic W. Buse

Sr. Engineering Consultant

Ingersoll-Dresser Pump Company

Allentown, Pennsylvania



Frederic W. Buse is a Senior Engineering Consultant at Ingersoll-Dresser Pump Company, where he has been employed for 34 years. He is a graduate of New York Maritime College, with a B.S. in marine engineering. He is a member of the Hydraulic Institute (which named him "Man of the Year" in 1976) and ANSI Committees B73.1 for horizontal centrifugal pumps and B73.2 for vertical chemical pumps. He has contributed to Marks' Standard Handbook for Mechanical

Engineers, Pump Handbook, and Pump Application and Design. He has written numerous articles for periodicals and has received 16 U.S. Patents on centrifugal and reciprocating pumps. He has contributed to API on writing the specifications for reciprocating pumps (API 674) and has also contributed to the writing of the ASME test code on centrifugal pumps. He represents the United States for writing the ISO centrifugal pump test standards. He is chairman of the Hydraulic Institute Test Standards Committee to ISO, and chairman of the Hydraulic Institute Sealless Pump Committee. He has also co-authored a paper, "Design of Magnetically Driven Chemical Pump to fit ANSI B73.1 Dimensions Using a Semi-Open Impeller" for the Seventh International Pump Users Symposium.

INTRODUCTION

Nonmetallic components have been used for the past 20 or more years, in corrosion services for sea water applications, electrical systems, chemical laboratories, structural corrosive environments, hydrocarbon tanks, and the automotive industry. The main reason for using them is not cost, but for resistance to corrosion.

The initial development of industrial nonmetallic component pumps with flanges and high pressure did not always have favorable results. However, the development of polymers, with reinforcements, has resulted in products that are competitive to metals. Epoxy and vinyl ester are replacing metal. Metallic storage tanks for highly corrosive liquids are being replaced by lined tanks of reinforced polymer. Underground metal gasoline storage tanks are being replaced by reinforced polymer tanks. Fifteen percent of the weight of new cars use composites. With the continuous improvement of polymers, users should consider the application of nonmetallic pumps.

Basically, metals corrode; nonmetallics do not. Therefore, consider the following when selecting a nonmetallic pump:

- Corrosion
- Concerns of Application
- Costs

PRINCIPLES OF CORROSION OF MATERIALS

Corrosion is discussed to help understand the corrosion performance difference between metals and composites as used in pumping applications. In corrosion, metals are always losing

material to electrochemical reactions, while composite materials last indefinitely or individual components of the composite degrade (i.e., either the composite works or it does not). The goal is to select a metal that has a very low material loss, less than 0.002 in per year of surface corrosion or to select a composite that will last indefinitely.

Corrosion in Metals

Corrosion in metals is caused by electrochemical reactions between the metal and electrolyte. The electrolyte in the case of pumps is the process fluid. For corrosion to occur, an anode and a cathode must be established. Direct current flows from the anode to the cathode through the electrolyte.

The anode and cathode can be two metals with different galvanic corrosion potentials.

An example of electrolytic corrosion is iron as the anode dissolving into the electrolyte as a positively charged iron ion, leaving two extra electrons in the metal (oxidation). At the cathode, the electrons join with hydrogen ions in the electrolyte to form molecular hydrogen gas (reduction).

The amount of corrosion in the metal is directly proportional to the amount of current flowing between the anode and cathode.

In some cases, the effect of oxidizing agents is to inhibit corrosion. This is true with aluminum, titanium, stainless steel, and certain bronzes. A tough oxide coating is formed that protects the metal from further electrolytic action. As in the above example, if the coating is removed or damaged, corrosion reoccurs.

The level of acidity or alkalinity of a fluid is important when applying metal pumps. The method used for measuring acidity and alkalinity is the pH system. This system cannot be used for strong acids and bases, since the pH is driven to extreme values. A neutral solution such as water has a pH of 7.0. The pH is on a logarithmic scale. A solution with a pH above 7.0 is an alkaline and a pH below 7.0 is an acid.

The general types of corrosion in metals are as follows:

- *Uniform attack*, the most common form of corrosion, is characterized by electrochemical reactions proceeding uniformly over the entire exposed surface. This type of corrosion can be managed easily since equipment can be selected with a known corrosion rate.

- *Galvanic corrosion* occurs when two dissimilar metals are in contact and exposed to an electrolyte and set up a galvanic cell. The further apart the two materials are in the galvanic series, the more chance there is for corrosion.

- *Intergranular corrosion* involves the localized attack at metal-grain boundaries. Damage can be severe, even though total weight loss is minimal. Welding on 303 and 304 stainless steel can create this type of corrosion. The high temperatures of the welding process cause the chromium to precipitate out, depleting the corrosion resistance in the weld area. Heat treatment after welding will redissolve chromium back into the metal, restoring its corrosion resistance.

- *Pitting* is the trickiest form of corrosion, causing equipment to fail by local perforation, without exhibiting any weight loss. The

pits or holes are easily recognized on the surface of the metal. In general, chlorides and other halogens foster pitting.

- *Concentration-cell corrosion/crevice corrosion* occurs when a metal is in contact with different electrolyte concentrations in the process environment. This localized corrosion is usually a result of crevices, scale, and deposits in the metal that create stagnant areas in the corrosive medium.

- *Stress corrosion* occurs from a combination of stresses in the metal and the corrosive environment. The stresses cause a breakdown of the corrosion resistant elements resulting in intergranular corrosion.

After understanding the type of corrosion in metals, it is important to realize that the rate of corrosion can be drastically affected by the temperature, pH (acidity), formation/removal of an oxide corrosion barrier (erosion corrosion), and the velocity of the solution.

Corrosion in Fiber Reinforced Polymers

The corrosion or material degradation, as it is referred to in fiber reinforced composites, is completely different from the corrosion process of metals. Since the fiber reinforced composite material (fiber and polymer) are nonconductive, an electrochemical reaction does not take place. The material degradation occurs in the resin, the reinforcing fiber, or the interface between the two, or in any of the components in the composite. If the material is going to be attacked, it will occur rather rapidly and a simple coupon test in the process solution, over several days to a few months, will indicate whether or not the material is corrosion resistant.

Temperature and fluid concentration are the only two process properties required to successfully select a fiber reinforced composite. The pH and the formation and removal of an oxide barrier are usually irrelevant. However, "cor-brasion," which is the softening of the surface by action of alkaline salt slurries, can cause problems.

When selecting composites, there is no such thing as a corrosion rate. Either the material is or isn't corrosion resistant! A simple coupon test or published corrosion guides indicate the suitability of a material on a given application. The exception is chlorine and oxidizing material can cause attack similar to metals at 180°F to 200°F, resulting in a corrosion rate.

From this analysis, one can see that selection of fiber reinforced composites can eliminate much of the guesswork in selecting materials as the projected metal corrosion rate from the electrochemical reaction is eliminated.

There are basic concerns when using composites. They are:

- Mechanical Properties
- Cost
- Temperature
- Abrasion Resistance
- Ultraviolet light
- Fire Resistance

CONCERNS

Mechanical Properties

Thermoplastics will bend and distort and then will fail with a sudden burst or crash.

Thermosets will expand and then slowly tear apart as pressure is increased. The tearing is the reinforcement (usually glass) being ripped from the resin. It sounds like snap, crackle, and pop!

Misapplication of thermoset plastics with corrosive fluid will leach out the resin or reinforcement and cause impeller imbalance.

Excessive nozzle loads usually do not result in nozzle failure, but cause excessive shaft misalignment, due to slipping of the casing on the bedplate or from distortion of the casing. The allowable nozzle load of nonmetallic pumps is approximately two-thirds to one-half that of a corresponding size of metal pump.

Abrasive Resistance

Abrasives on 316 stainless steel continuously remove the protective oxidation surface of the metal. Since vinyl esters and epoxies do not need the oxidation layer, it gives better life with mild abrasives. However, they can be attacked by caustics by corbrasion.

Temperature

Most composites used on pumps are limited to under 300°F.; however, most corrosive liquids are applied below 250°F. There is a reduction of mechanical properties as a linear function of temperature. As is done with metallic pumps, manufacturers should state the pressure-temperature limitation.

Costs

There are two ways of looking at the costs of a noncomposite: The initial capital outlay and hidden costs associated with installation, operation and maintenance. The latter is hard to determine and can make justification difficult.

Initial Cost

Depending on material required for the application, the cost of the composite can be equal to or much less than metallurgically equivalent metal pumps. (Figure 1):

- Cost of composite is equal to or slightly greater than 316 stainless steel cost.
- Cost of composite is 80 percent of alloy 20 cost.
- Cost of composite is 50 percent of a Hastelloy C cost.

Hidden Costs

- Since there is little or no corrosion with composites, the life of the parts is increased, increasing the time between maintenance shut downs.

- The component parts weigh 25 to 33 percent of the weight of metal parts. They are easier to handle for maintenance.

- The impeller requires little to no balance because the residual imbalance is less than the allowable required by standards.

- The composites are good insulators and usually do not require any additional insulation. This not only saves process heat, but also does not require maintenance personnel to maintain them, remove and install insulation for maintenance.

- On immersible sump pumps, which can be three to 10 ft long, the weight of a composite pump is 70 to 90 percent less than a metal pump. This makes it much easier to install and remove a composite pump from a sump pump.

- The liquid ends of a composite pump do not have to be painted, thereby reducing the overall maintenance.

- In corrosive atmospheres, the standard metal bedplates can rot away, introducing misalignment of the shafts and causing excess nozzle loads. A composite bed may cost 30 to 60 percent more, but it eliminates the above problems; further, the user also gains standard features such as drip lip, sloped surface and ringed grout holes.

- In magnetic drive pumps, when a shell is made from a nonmetallic material, there are no eddy current losses. This reduc-

es the power consumption by 15 to 20 percent, from that of a Hastelloy shell. This also eliminates temperature rise in the fluid going past the magnets.

- In general, composite pumps and bedplates have less vibration and run quieter, which results in lower vibration reduction costs than for metal components.

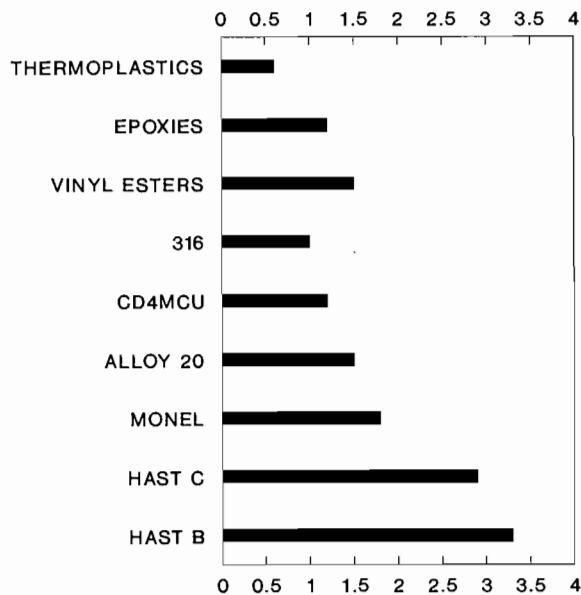

Figure 1. Relative Costs.

Ultraviolet Light Protection

Stabilizers are added to the resin to prevent damage from ultraviolet light.

Fire Resistance

Most composites will experience heat distortion upon reaching temperatures around 400° to 500°F. Under fire conditions, thermoplastics will melt; thermoset will char. If a pump is still pumping under fire conditions with nonmetallic piping, the liquid will stay cooler with the nonmetallic than with metal, due to insulating properties. If the fire is hot enough, the pipe will expand to relieve internal pressure buildup.

Fire retardant additives, such as halogen, bromide or antimony oxide, can be added to composites to act as snufflers, but may affect the mechanical and electrical properties of the material. Many nonmetallics are self-extinguishing under fire conditions. The manufacturer should be consulted if there is a possibility of release of toxic gases under fire conditions.

DIFFERENT TYPES OF COMPOSITE PUMPS

Engineered Composite Pumps

The family of nonmetallic composites include a large variety of various polymers. Used in virtually every type pump part, either as coating or as structural materials of construction, nonmetallics offer designers, manufacturers and ultimate end-users a broad array of benefits.

Proper selection of nonmetallic materials offers many combinations of *improved corrosion resistance, lighter weight, flame retardance, lower costs, magnetic transparency, and complexity of unitized part designs*. As nonmetallic materials with higher moduli and higher allowable temperatures become commercially available, so will more replacement of metal parts.

The term "Composites" generally includes two large groups of organic compounds which differ considerably in their makeup. There are thermoplastics and thermosets. Proper material selection for a particular application has allowed nonmetallic substitutions in otherwise traditional metallic parts, such as *shafts, pull rods, valve seats, pump casings, impellers, bushings, wear rings, ball bearings, and many more*. Benefits, other than cost alone, direct design engineers to consider nonmetallic alternatives for longer life and higher quality.

The current development in nonmetallic (composite) pumps uses parts molded from compounds of reinforced thermoset resins.

These pumps do not use the armor found in rigid lined pumps. Pumps using these reinforced thermoset compounds have strengths similar to metallic pumps and exhibit excellent corrosion resistance. These pumps successfully handle acids, alkalis, oxidizing agents, solvents and salts, at normal operating temperatures to 250°F. While exhibiting similar mechanical properties and superior corrosion resistance, these pumps are even more attractive, since their cost is about equal to that of pumps made of 316 stainless steel metal. In the past, nonmetallic pump technology has been referred to as FPR (fiber reinforced plastics), but today is more commonly referred to as engineered composites.

Polymer Processing

Polymers are formed by the resin/chemical company in a process called polymerization. The polymer is formed under the reaction of a catalyst, pressure, and heat inside vessels or reactor tubes. The polymer is then shipped to the processor in pelletized, granulated, powdered, or liquid form. At this stage, the polymer is referred to as resin. The processor typically combines other materials with the resin, to form a compound. These other materials include colorants, flame retardants, heat or light stabilizers, lubricants, glass or carbon fibers, minerals, hollow glass spheres, and/or other polymers. The composite is designed to have properties superior to the component materials by themselves. Adding fillers or reinforcements to resins increases the overall performance of the composite. A common reinforcing technique is adding glass fiber to resin which, when molded, leaves the composite with higher strength properties than the resin alone. This reinforcement is similar to the way steel rebar strengthens concrete.

Thermoplastics are made from long-chain organic materials that melt at some specific elevated temperature, depending on the material. They can be amorphous or crystalline in structure. For improved physical properties, various reinforcements may be utilized, such as glass or mica. Most thermoplastic pumps are smaller size non-ASME/ANSI B73.1, closed impeller designed with application temperatures of less than 150°F. Typical applications would be swimming pools, shallow wells, plating tank circulation, fresh water, corrosion resistant sumps, food handling, etc.

Thermoplastics do not undergo a chemical change in their processing and, therefore, will become "pliable" upon reheating above their yield temperature.

Thermoplastic materials are available in a wide range of strengths and application envelopes. In general terms, thermoplastics can be divided into *fluoropolymers* (i.e., PFA, PTFE), *engineering plastics*, (i.e., LCP, PPS) and general (ABS, acrylics, polyethylene, PVC and polypropylene), just to mention a few. Thermoplastic processes, such as injection molding, vacuum forming, extrusion and blow molding, offer the design engineer many selections for optimum cost considerations. Considering the large number of reinforced variations of thermoplastics, a designer is likely to have more applicable nonmetallic alternatives than metallic choices for a particular application.

Thermosetting polymers, generally reinforced with fiberglass or carbon (graphite) fibers are repeating groups of chemical chains

polymerized into a solid matrix. During the molding cycle, these materials undergo a *chemical change* (molecular), which is irreversible. In other words, these thermosetting materials will not soften or become flowable by reheating the parts.

Thermoset composite pumps are made from a cross-linked unsaturated polymer resin, such as epoxy, unsaturated polyester, or vinyl ester resin reinforced with glass fibers. Other reinforcements are sometimes utilized, such as carbon fibers. These specialty high-strength reinforcements are currently gaining wider usage. However, glass fibers remain the major reinforcement medium. Thermoset plastics have good high temperature characteristics. They exhibit good resistance to creep; as application temperatures increase, they eventually char. Thermoset composite pumps are typically manufactured by one of several methods. They may be compression molded, resin transfer molded, or cast.

Thermoset composite pumps (Figure 2) are currently produced in ASME/ANSI B73.1 6.0 in through 13 in impeller sizes. They may be applied to pumpages with temperatures as high as 250°F and pressures to 250 psi. (Individual manufacturers have specifications which may vary from this general guide.) They demonstrate good resistance to acids, bases and oxidizing agents. Typical applications are in CPI markets, oil patch applications, pulp and paper industries, and other applications where corrosion resistance is of concern.

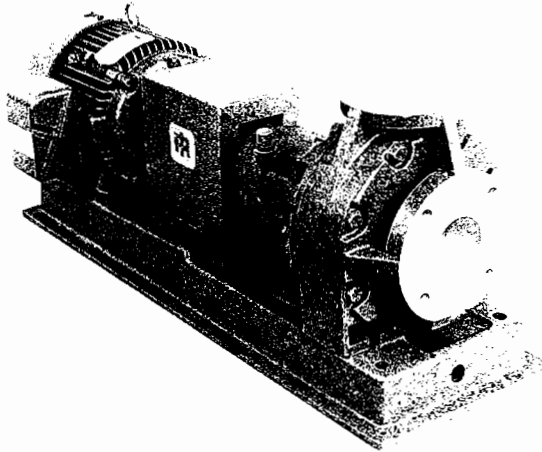

Figure 2. Photos of a Reinforced Thermoset Pump.

FLEXIBLY LINED PUMPS

Flexibly lined pumps typically are metal pumps with a thin corrosion liner attached to the internal wetted surfaces. In the case of the more common teflon-lined pumps, the liner has approximately a 1/8 to 3/16 in thickness. The cast iron provides the necessary structural rigidity and the liner provides the desired corrosion resistance. All of the "wetted" surfaces are covered with a thin lining.

RIGID LINED (ARMORED) PUMPS

In this product, the entire pump casing and cover is molded from virgin materials (i.e., the molded material does not contain any reinforcement). The pressure rating of the molded pump parts by themselves is very low. Therefore, in order to increase the pressure rating, flat plates have been bolted onto the front and back of the casing, adding structural strength to the molding. These plates are considered the pumps "armor." Some manufacturers use threaded on flanges which add to the number of potential leak paths.

With a rigid lined pump, the wetted components are molded out of materials such as carbon, PTFE, CPVC, or PVDF. In order to increase the structural rigidity and pressure containing capability of the pump, the molded nonmetallic parts are held in compression between two metal plates. Fillers are added to the resins of these nonmetallic parts which improve the moldability of the parts, but do not increase their strength.

Ceramic/Carbon Pumps

Solid ceramic and carbon pumps are much more expensive than comparable pumps in the market. These pumps are designed for specialty applications where metal and polymer type nonmetal pumps cannot be used. For example, the carbon pumps can handle high concentrations of HF (hydrofluoric acid).

Comparative Advantages and Disadvantages

A general comparison is exhibited in Table 1 of the many advantages and disadvantages of reinforced composite, armored, flexibly lined and metal pumps.

Table 1. General Comparison of Pump Types.

FEATURE	REINFORCED COMPOSITE	FLEXIBLY LINED	ARMORED	THERMOPLASTICS
Cut impellers typically available	Yes	No & Yes	Yes	Yes
Potential for damage to corrosion resistance during repair	Low	High	Low	Low
Integral casing flanges	Yes	Yes	No	No, usually threaded
Efficiency	High	Med	Med to Low	Med
CPI Hydraulic Coverage	Broad	Limited	Limited	Very Limited
Product available conforming to ASME/ANSI B73.1M	Yes	Yes	No	No
Cost	Med	High	Med to High	Low
Pressure Capability	Med	High	High	Low
Temperature Capability	Med	High	High	Med to Low

TECHNIQUES FOR MOLDING POLYMERIC COMPOUNDS FOR PUMP COMPONENTS

Composite pumps are made from thermoplastics and thermosets. Each process has benefits for the application as shown in Table 2.

Reinforcement

Glass or carbon fibers are used as reinforcing members in the composite material. The combination of fibers and a resin compound results in a material with properties superior to those found in either component.

Fibers have several inherent qualities that are critical to the resolution of structural problems in plastics: high strength to weight ratio, dimensional stability, resistance to temperature extremes, resistance to corrosion, and ease of fabrication.

There are several commercially available forms of glass fibers. Chopped strand is supplied as bulk-cut strands 1/16 to 1/2 in in length. The chopped strand of glass are mixed into a molding compound that is used in compression molding and injection molding. Continuous or chopped strand mats are used in resin transfer molding.

Molding

• Injection Molding (Thermoplastics)

• Advantage: Smaller parts can be produced in higher quantities at low cost.

Table 2. Selection Criteria for Thermoset and Thermoplastic.

PROCESS	THERMOSET	THERMOPLASTICS
Average range of molded thickness	.030 to 2.0 in.	.06 to .38 in.
Weight range of molded piece	1 to 500 lbs.	.5 to 5 lbs.
Glass content range (by volume)	50 to 60%	30 to 40% (glass degrades when put through the auger of the injection machine.)
Length of glass fiber	.25 in. to several inches	.060 in.
Strength	Not uniform throughout	Basically uniform.
Minimum annual quantities for design criteria	Less than 1000	10,000
Obtain additional strength with ribs	Not necessarily	Yes
Tooling	Depends on complexity and size	Generally 15 to 20% higher than compression molding, but offset by volume of quantities.
Process comment	Compression or Resin Transfer Molding	Injection, cannot use compression molding because not enough heat to obtain proper melt flow.

Disadvantage: Injection molds and equipment are relatively expensive. Smaller parts only.

The smaller wetted components of the pump are injection molded. These parts include the shaft sleeves and impeller nuts. Since these parts must be precise for proper sealing fits and are used in higher quantities, injection molding is the best choice. A listing of various thermoplastics is shown in Table 3.

Table 3. Thermoplastics.

Chemical	Temperature Limit*
Polycarbonate	250
Phenylene Oxide**	194
Polyphenylene Sulfide**	250
Polyphenylene	150-180
Chlorinated Polyvinyl Chloride	230
Polyvinylidene Chloride	160
Polyvinyl Chloride	140
Chlorinated Polyvinyl Chloride	230
Polyetheretherketone	250
Polytetrafluoroethylene	460
Chlorotrifluoroethylene	500
Polyvinylfluoride	300

* Maximum continuous degrees F.
 ** Glass-reinforced
 *** Will not melt, good in Zone 0

- Resin Transfer Molding (RTM) (Thermoset)
 - Advantage: Lower initial cost for tooling than compression molding. Structural strength increased with properly placed reinforcement.
 - Disadvantage: More hand labor involved. Much higher per piece cost than compression molding. Less dimensional accuracy and more post mold machining required than with compression

molding. Structural strength decreased with improperly placed reinforcement.

The process to make a casing begins by precision molding a volute out of a removable core material. The volute is wrapped in several layers of glass reinforcement. The glass reinforcement is oriented to optimize the overall strength of the finished composite part.

Cutting patterns are used to ensure the shape consistency of the glass mats. The wrapped core is placed into the glass laden cavity of the mold. The mold is then closed and prepared for the transfer of resin. The resin is thoroughly mixed with a catalyst and maintained at an exact temperature to ensure proper curing once inside the mold. The resin and catalyst mixture is forced into the mold under pressure. The pressure is used to ensure that the resin permeates all voids between the glass. The casing is removed from the mold after curing. The core, still, is then removed by heat or chemical dissolving. Once the entire molding process is performed, the casing is machined as required

- Compression Molding (Thermoset)
 - Advantage: Lower per piece cost. Very precise components requiring little or no machining. Yields a very dense void-free material.
 - Disadvantage: High cost of mold and press machinery due to the higher temperatures and pressures involved.

The process begins by mixing the molding compound. A small amount of completely inert "fillers" are used to add dimensional stability, improve bonding between the glass and resin, reduce the sensitivity to liquid at the surface, and improve the molding process.

The exact amount of molding compound is measured out and placed into the lower half of the precision steel mold. The mold is closed under high pressure. The temperature of the mold is closely controlled. The high pressure and temperature allows the part to cure in a matter of minutes. After curing, the part is removed with ejector pins built into the mold.

A listing is shown in Table 4 of various thermosets used in pumps.

Table 4. Thermosets.

NAME OF COMPOSITE	COMMON TRADE NAME	CHEMICAL
VINYL ESTER GL	VE	VINYL ESTER
VINYL ESTER CL	VE	VINYL ESTER
EPOXY		EPOXY
GL - GLASS REINFORCED (SHOULD NOT BE APPLIED TO HYDROFLURIC ACID AND CAUSTIC USE CARBON FIBERS)		
CL - CARBON REINFORCED		

PUMP SELECTION/APPLICATION GUIDELINES

Principles of Corrosion

Temperature Limits for Various Polymers in Different Liquids

Polymers are divided between Thermosets and Thermoplastics.

- Thermosets:
 - vinyl esters
 - epoxies
 - polyesters
- Thermoplastics:

- CPVC (chlorinated polyvinyl chloride)
- PVC (polyvinyl chloride)
- polypropylene
- polyethylene
- polyester
- PVDF (polyvinylidene fluoride)
- PTFE (polytetrafluoroethylene)
- PPS (polyphenylene sulfide)
- PEEK (polyetheretherketone)

A comparison of the corrosion capabilities with temperatures of these materials is shown in Table 5. This table should only be used as a rough guide when determining the suitability of polymers in the mentioned fluids. This guide does not take into consideration the ability of the materials to contain pressure. Pump parts made from these materials require reinforcement to handle higher pressures. The effect on modulus of elasticity with temperature is shown in Figure 3.

Table 5. Maximum Temperatures of Polymers in Various Liquids.

CORROSION RESISTANCE OF COMMON POLYMERS IN DIFFICULT PROCESS FLUIDS										
MAXIMUM RECOMMENDED TEMPERATURE (DEG. F)										
TYPE	FLUID		COMMON	VINYL					POLY-	
				ESTER					PROPYLENE	
Acids	Hydrochloric Acid	HCl	374	180	165	70	274	260	200	70
	Sulfuric Acid	H ₂ SO ₄	724	120	140	70	200	350	200	140
	Nitric Acid	HNO ₃	201	150	165	140	140	250	200	70
Alkalies (Caustic)	Potassium Hydroxide	KOH	451	100	200	185	165	300	250	185
	Sodium Hydroxide	NaOH	501	210	200	100	200	300	200	160
	Ammonium Hydroxide	NH ₄ OH	271	100	300	150	275	300	200	225
	Sodium Chloride	NaCl	541-0	210	200	150	275	400	70	200
Oxidizers	Sodium Hypochlorite	NaOCl	181	180	200	100	100	300	200	140
	Hydrogen Peroxide	H ₂ O ₂	301	150	140	70	240	400	140	70
Organics (Solvents)	Benzene	C ₆ H ₆	1001	100	NR	NR	125	390	300	NR
	Toluene	C ₆ H ₅ CH ₃	1001	120	NR	NR	200	400	40	120
	Ethyl Alcohol	C ₂ H ₅ OH	951	150	140	70	310	390	300	200

NR - Not Recommended
 N/A - No Data Available

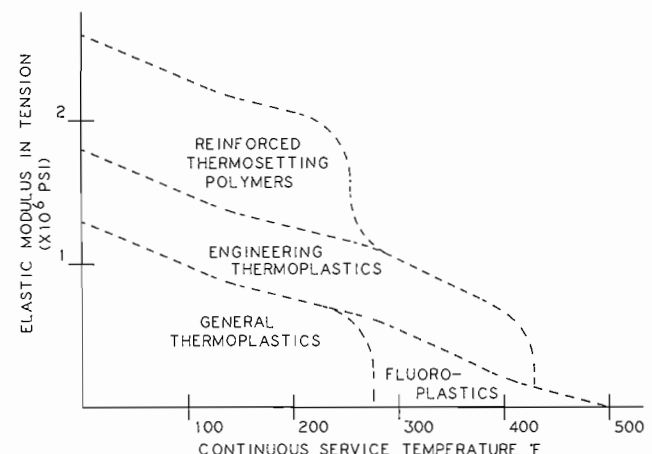

Figure 3. Modulus of Elasticity Vs Temperature.

MECHANICAL PROPERTY CHARACTERISTICS OF COMMON POLYMERS

There are fundamental properties used to describe and compare the mechanical integrity of polymer resins. These properties are discussed here and are summarized in Table 6. When designing load bearing structures, traditional engineering design methods are based on the amount of deflection under a load. The property used to define the ability of a material to resist deflection is the modulus of elasticity. The modulus of elasticity is defined as the amount of stress required to produce 100 percent

Table 6. Mechanical Properties of Common Polymer Resins.

FUNDAMENTAL PROPERTY (ARBITRARY TEMPERATURE)	STEEL	ALUM	GLASS	VINYL ESTER	CPVC	PVC	PVDF	PTFE	PP	POLY-PROPYLENE	EPDM	PEEK
MODULUS OF ELASTICITY (1 X 10 ⁶ PSI)	29	10	5	3.5	0.4	0.4	0.16	0.0	0.55	0.2	3.5	0.56
TENSILE STRENGTH (1X 10 ³ PSI)	60	18	300	11	10	7	7	4	14	6	16	16
SPECIFIC GRAVITY	7.6	2.7	2.6	1.2	1.3	1.3	1.0	2.2	1.3	0.9	1.25	1.31
COEFFICIENT OF THERMAL EXPANSION (10 ⁻⁵ IN./IN./F)	0.6	1.3	0.3	2.0	4.4	2.0	0.5	10.0	2.0	0	2.2	4.0

strain. The value for a material is usually determined by measuring the stress at smaller strains and calculating the ratio.

$$\text{Modulus of elasticity} = \frac{\text{Stress}}{\text{Strain}}$$

Of the common metals, steel has the highest modulus of elasticity (29 × 10⁶ psi), which is roughly 60 times higher than the modulus of rigid plastics. Zinc, brass, and aluminum have modulus of elasticity approximately one third that of steel.

Also, the tensile strength is used to define and compare the ability of a material to handle loading. Again, steel has the highest tensile strength (60 × 10³ psi), which is roughly five to six times the tensile strength of unreinforced polymers.

Another property used to compare polymers is the rate of thermal expansion measured in inches per inch per degree Fahrenheit (in/in/F). Hardness is also used for comparison, but is very difficult to define when the hardness varies from point to point as in composites.

With significantly lower strength properties than the common metals, how can polymers compete? In designing structural parts where deflection is important, the mass of the structure in addition to the load must be considered. The ability to mold polymers into complex shapes (without waste or scrap) makes it easier and less expensive for the engineer to design structures with more of the mass away from the neutral axis. Structures with this type of design will resist bending much like a steel "I" beam.

Thermoplastics differ from metals in their tendency to creep or stretch, whereby thermosets fail in a tearing mode which will not rejoin itself. Thermoplastics subjected to tensile stresses, which can be less than one third of the ultimate tensile strength, will creep in the direction of the imposed stress. On the other hand, yield strength of metals is much closer to tensile strength. Metals also have the ability to retain their structural properties at higher temperatures and stresses, so care must be taken to insure that the environment does not exceed the recommended operating range of the polymer.

A comparison of the fundamental mechanical properties of polymer resins is shown in Table 6. Steel and aluminum are included in the table, for comparison.

Note: The properties shown in this table can be considerably different with the proper use of reinforcement. The values in the table are for resin only.

The effect of reinforcement on some of the materials is shown in Table 7.

A range chart is shown in Figure 4 of developed pressure vs gallons per minute for application of thermoplastics, thermosets, and metal chemical pumps.

APPLICATION

The following is a list of various chemicals, and the by-products that they are associated with. For each major chemical that is a candidate for nonmetallic pump, there is a list of associated liquids that are candidates for nonmetallic pumps.

Liquids That are Nonmetallic Candidates

- Chlorine and Caustic (Sodium Hydroxide) NAOH

Table 7. Effect of Reinforcement with Thermoplastics.

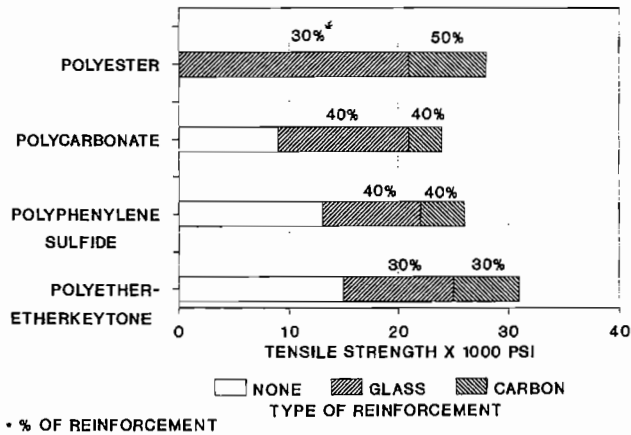

- Sodium Hypochlorite—used on brine
- Hydrochloric Acid (Muriatic Acid)—Replaces hastelloy titanium
- Sulfuric Acid (70 percent concentration)
- Ferrous and Ferric Chloride—replaces titanium
- Ethylene Propylene—Antifreeze
- Producers of Dye
- Agricultural Chemicals
- Pump and Paper
- Metal Finishing
- Desalination and Water Purification
- Industrial Waste Treatment
- Power Generation
- Aquarium

The general effect of liquids on composites is shown in Table 5.

Producers of Chlorine and Caustic

Chlorine is used for producing organic chemicals such as vinyl chloride, chlorinated solvents, propylene oxide, pesticides, and fluorocarbons; producing pulp and paper; producing inorganic chemicals' sanitizing potable and wastewater in municipal waterworks and sewage plants.

Sodium hydroxide is consumed by the chemicals industry; pulp and paper industry; and the aluminum, rayon-cellophane, petroleum refining, soap and detergent, and food industries.

Chlorine and its sodium hydroxide by-product are typically produced from the electrolysis or separation of sodium chloride (brine). Less common methods are the electrolysis of potassium chloride, electrolysis of magnesium chloride, electrolysis of hydrochloric acid, or the reaction of nitric acid and potassium chloride.

Possible fluids (not mixtures) for nonmetallics:

- Sodium Hydroxide
- Potassium Hydroxide
- Sodium Chloride Solution
- Brine
- Seawater
- Magnesium Chloride Solution

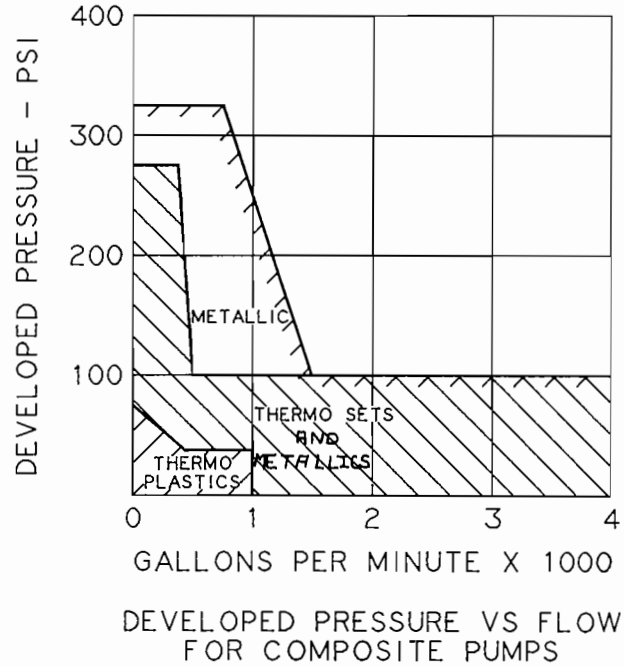

Figure 4. Pressure Vs Flow for Composite Pumps.

- Sulfuric Acid, dilute up to 70 percent
- Hydrochloric Acid
- Sodium Hypochlorite
- Nitric Acid up to five percent

A hydrochloric acid ISO bar chart is shown in Figure 5.

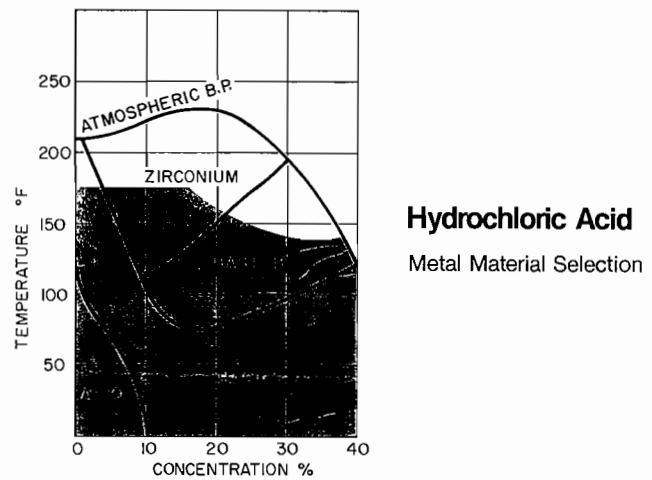

Figure 5. Material Selection for Hydrochloric Acid.

Producers and Users of Sulfuric Acid

Some nonmetallic pumps cannot be used in the production of the high concentration sulfuric acid (98 percent). However, sulfuric acid at this concentration can typically be handled by cast iron pumps. The vinyl ester can be used on lower concentrations (< 80 percent) found in waste treatment and dilute processes (Figure 6).

Sulfuric Acid

Metal Material Selection
GRP Suitability

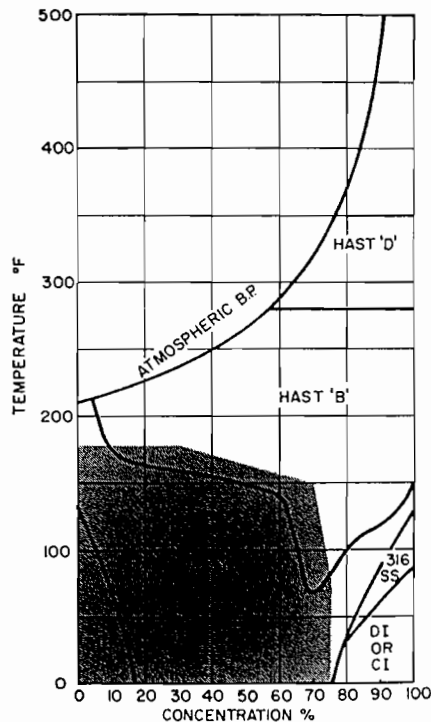

Figure 6. Material Selection for Sulfuric Acid.

Producers and Users of Ferrous and Ferric Chloride

Ferric chloride is used commercially as an etching reagent on copper clad printed circuit boards in the electronics industry. Ferric chloride is also used as a chemical coagulant in water or wastewater treatment. The coagulant, through chemical reaction, causes suspended and colloidal matter to precipitate out of solution. Ferric chloride is produced in pickling operations where hydrochloric acid reacts with the surface of the iron or steel.

The reaction of iron with hydrochloric acid in the absence of oxygen produces ferrous chloride; the reaction of iron with hydrochloric acid in the presence of oxygen yields ferric chloride.

Ferric chloride is commercially available in 40 percent concentration solution. This is an excellent application for nonmetallics, since titanium metal pumps must be used.

Possible Fluids:

- Ferric Chloride—(FeCl₃)
- Ferrous Chloride—(FeCl₂)
- Hydrochloric Acid—(HCl)

Producers and Users of Ethylene and Propylene Glycol

Possible Fluids for Nonmetallics:

- Propylene Glycol
- Ethylene Glycol
- Hydrochloric Acid
- Dilute Sulfuric Acid
- Diethylene Glycol

- Dipropylene Glycol
- Polypropylene Chlorohydrin

Producer of Dyes

The three most common dye types produced today are acid, sulfur and Diazo dyes. The production processes used to make these dyes varies from manufacturer to manufacturer. Glass reinforced composite equipment is used in many of the processes.

Possible Fluids for Nonmetallics:

- Sulfuric Acid—(H₂SO₄)
- Hydrochloric Acid—(HCl)
- Wide variety of fluids, depending on processes involved.

Agricultural Chemicals

Three widely used categories of chemicals used in agriculture are pesticides, fungicides, and fertilizers. The pesticides are divided into subcategories of insecticides and herbicides. Most of the products are chlorinated (or brominated) hydrocarbons and severely corrosive processes are used.

Due to the inability of the nonmetallics to perform on many chlorinated hydrocarbons, it is imperative to have complete details of the process before applying the nonmetallic in this market segment.

Possible Fluids:

- Hydrochloric Acid
- Chlorine
- Chlorinated Hydrocarbons

Producers of Pulp and Paper

The two main areas of interest for corrosion resistant nonmetallic pumps are bleaching and cooking liquor preparation. Nonmetallics can possibly be used during the chip digestion process as it can handle a range of white, black and green liquors.

Possible fluids:

- White Liquor
- Black Liquor
- Green Liquor
- Sulfuric Acid
- Sodium Hypochlorite
- Chlorine
- Peroxide Bleach
- Chlorine Dioxide
- Sodium Chlorate
- Sulfur Dioxide
- Methanol
- Sodium Chloride
- Hydrochloric Acid
- Sodium Hydroxide

Metal Finishing

Metal finishing falls into several main categories such as electroplating, steel pickling, chemical milling, etching, anodizing, and galvanizing.

The nonmetallics are an excellent choice for plating processes, due to its corrosion resistance and its inability to generate the stray currents produced by metal pumps, which can affect the plating process.

Possible fluids:

- Hydrochloric Acid
- Sulfuric Acid
- Ferrous Chloride
- Zinc Sulfate
- Zinc Chloride

Desalinization and Water Purification

There are two primary methods used for desalinization and water purification. The first and oldest method is distillation and the other is reverse osmosis. Nonmetallic pumps are a good choice for the seawater recycle, seawater blowdown, seawater heater, seawater backwash pumps, and other auxiliary pumps in this process. Metal pumps on seawater service are either 316 Stainless steel, CD4MCu, or alloy 20.

High pressure water is purified by passing through a membrane in the reverse osmosis process. Reverse osmosis units are much simpler, are more compact, are more energy efficient, and operate at lower temperatures (less corrosion) than the distillation process.

Nonmetallic pumps are used on the chemical treatment, backwash, membrane slowdown, and intake screen wash services.

Possible fluids:

- Seawater
- Brine
- Chlorine
- Sulfuric Acid
- Sodium Hypochlorite

Industrial Water Treatment

The waste products from industry are derived from cooling, washing, flushing, extracting, impregnating, chemical treatment, cleaning, and other similar operations. They are as varied in quantity and nature as the products and processes of the industrial plant from which they come.

The treatment of fluid wastes exists in many industries. The ability of the nonmetallics to handle a wide range of corrosive fluids makes it worth considering for waste treatment and handling applications. Most vinyl esters can handle organic fluids.

Power Generation

Water used in the closed loop steam cycle must be processed to remove its impurities. Depending on the source and location of the water supply, the impurities can affect plant operation.

These impurities and combinations of impurities will vary from plant to plant. Many service opportunities do exist for nonmetallic pumps in the area of water treatment for power generation.

Possible fluids:

- The fluids handled will vary with the treatment process.

Aquatic Life Support (Aquariums)

Many nonmetallic pumps are used in aquatic life support systems. Since aquariums are isolated and often crowded seawater habitats, it is imperative that wastes be continuously removed from the water. The wastes are removed through a variety of pressurized filtration processes. Nonmetallic pumps are also used for seawater transfer, seawater intake, washdown, and filter backwashing applications.

Experience has also shown that the aquatic life is affected by stray electrical currents produced by the impeller rotating in the casing when metal pumps are used. The nonmetallic pumps do not produce these currents.

Due to its corrosion resistance, nonconducting characteristics and low cost, the largest aquarium consultants in the world recommend the use of nonmetallic pumps to their clients.

Possible fluids:

- Seawater

TYPICAL PUMP COMPONENTS

A cross section is shown in Figure 7 of an industrial composite pump.

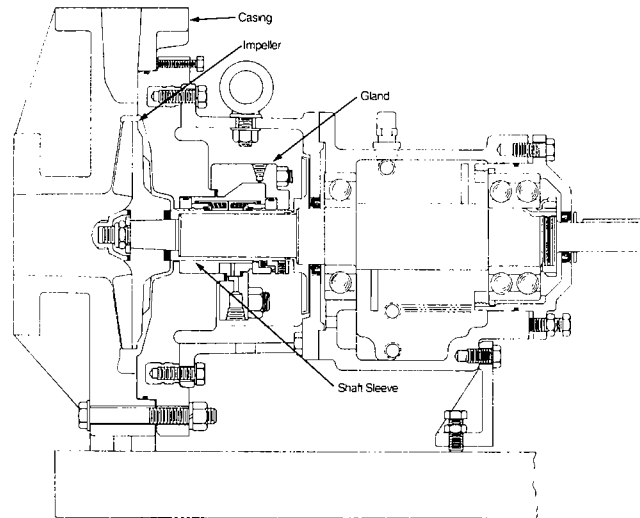

Figure 7. Cross Section of Reinforced Thermoset Pump.

Impeller (Figure 8)

A concern with nonmetallic pumps is the attachment of the impeller to the shaft. Depending upon the speed and horsepower, most impellers cannot use a single key for attachment, due to the stress levels of the material. Many impellers are, therefore, attached by using threaded inserts molded within the impeller. The problem here is that care has to be taken to ensure that excess stress will not occur around the surface of the insert relative to the material, and result in a weak surface between them.



Figure 8. Components Made of Thermoset.

An alternate method of attachment is a multikeyed or polygon shape, which does not require an internal insert because the stresses of the material are distributed throughout its circumfer-

ence, relative to the shaft surface. The disadvantage of this attachment is that there are more surfaces that have to be sealed to prevent external fluid from attacking the shaft.

Casings (Figure 8)

Unlike metallic pumps, there are no standards for the pressure temperature ratings of the flanges; the ratings change at present from one manufacturer to another and from material to material. Good design practices have shown that the reinforced vinyl ester and epoxy flanges have the capability, at ambient temperature, to be equivalent to that of metal 150 lb flanges of the same dimensions. The pressure temperature gradient is a linear factor and degrades above 100°F. Heavy wall vinyl ester is a good insulator which makes the temperature gradient from the liquid side of the pump case to atmosphere about 100°F, based on tests of heat soaking the vessel for 24 hours. This allows for higher pumpage temperatures without causing excess bearing temperatures; it is also good for the user, since there will be little loss of heat from the fluid while passing through the pump.

To obtain additional strength, some manufacturers employ metal backup rings, which are either separate pieces bolted to the support head or they have support heads which include a backup ring. The torquing of the bolting should be done to the recommended values of the manufacturer, in a progressive sequence pattern of 20, 50, 70, and 100 percent of the maximum value.

Nozzle Loads

At the present time, there are no standards for nozzle loads on ANSI pumps, and reference is usually made to the manufacturer for the maximum load. The criteria used by the manufacturer for maximum nozzle load is usually the movement on the coupling end of the shaft; this may be 0.005 to 0.010 in, depending on the size of the pump. This deflection can be caused by:

- Movement of the entire assembly when the load is applied.
- Movement of the feet of the casing relative to the bed plate, due to the friction force between them.
- Movement of the bearing housing relative to the bed plate.
- Deflection of the bed plate surface relative to the driver shaft.
- Nozzle load limits can also be due to internal movements causing rubbing of the impeller against the casing.

For nonmetallic pumps, the allowable nozzle loads are much lower than for metallic ones because the casing feet move or deflect under a much lighter load. When nonmetallic beds are employed with either a metallic or a nonmetallic pump, movement of the top surface of the bed is the deflecting member of the assembly, resulting in lower allowable nozzle loads. This will occur whether the bed is grouted or ungrouted.

Gasketing

In nonmetallic pumps, most of the main gaskets are confined O-rings, either round or square cross section. This reduces the stress on the main bolts. If the gasket surface requires final machining, it is advisable to coat the surfaces with the base resin, to prevent wicking of the pump fluid through the exposed ends of the glass reinforcement and consequent leakage of the gasket.

To reduce the area stress from the bolt head or nut loading, it is recommended that when washers are used, their diameter should be at least three times that of the bolt.

The standard gasketing materials used in nonmetallic pumps is fluorinated hydrocarbon, or more commonly known as viton-A. Other materials are also available as an option.

Bolting and Metallic Inserts

Threaded studs into the casing will impose tension in the composite case during assembly, so it is preferable to use through bolting; this leaves the casing in compression rather than tension. When through bolting cannot be used, the bolts or studs should be fastened into stainless steel, or alloy inserts may be molded into the piece. The inserts are knurled and grooved on the outside to prevent twisting or pulling within the piece when torque is applied to the fastener. The inserts are usually a Class 3 fit on the inside diameter for the fasteners. A blind end insert is used to provide a positive stop for the studs. When inserts are used, it is best to mold them as part of the piece rather than insert them afterwards. When they are molded in this way, they should be located so that their surfaces terminate below the molded surface.

All bolting and inserts used on the nonmetallic pumps are made of 303 stainless steel, as a minimum. Nonmetallic studs are used on some pumps.

Shaft

The standard shaft is usually a high strength AISI 4140 carbon steel. A carbon steel shaft can be used effectively in corrosive services, since it is designed to be completely unwetted, even in the event of a seal failure.

Shaft Sleeves (Figure 8)

The shaft sleeve is used to protect the shaft from the process fluid and mechanical seal wear. The shaft sleeve can be made of injection molded glass reinforced polyphethylene sulfide (PPS).

The shaft sleeve can be a separate piece, which is usually made by injection molding, or can be made integral with the impeller; there are advantages and disadvantages to both. When integral with the impeller, the entire impeller sleeve mechanism needs to be replaced if something goes wrong with the sleeve. When a separate shaft sleeve is used, there will be an additional sealing surface between the impeller and the sleeve, which has to prevent fluid from coming into contact with the shaft. When nonmetallic sleeves are used, mechanical seals with Teflon wedges should not be employed, because of the excess fretting. The designer also has to consider the extrusion from the holding force of the set screws on soft nonmetallic sleeves. Split clamping rings using a radial type of set screw are sometimes used to prevent damage to the shaft sleeve.

The shaft sleeves are usually of the hook type variety, to allow for axial thermal expansion.

Shaft Sealing System

If the stuffing box glands are made of composite material (Figure 8), they must be capable of withstanding the applied torque without creeping. Depending upon whether an inside or an outside seal is used, the gland may need additional reinforcement with either a metallic backup or an extra strength reinforcing cloth. When designing the stuffing box area, the heat transfer of the injection fluid around the seal should also be considered; the larger this area can be made, the longer the life of the mechanical seal.

Mechanical Seals

There are only two seal configurations that can be completely nonmetallic: single outside mechanical seals and double mechanical seals (Figure 9).

Outside Mechanical Seal

The corrosive properties of fluids used within nonmetallic pumps are such that many pumps use outside mechanical seals. As a result, the only wetted pieces are the stationary seat and the

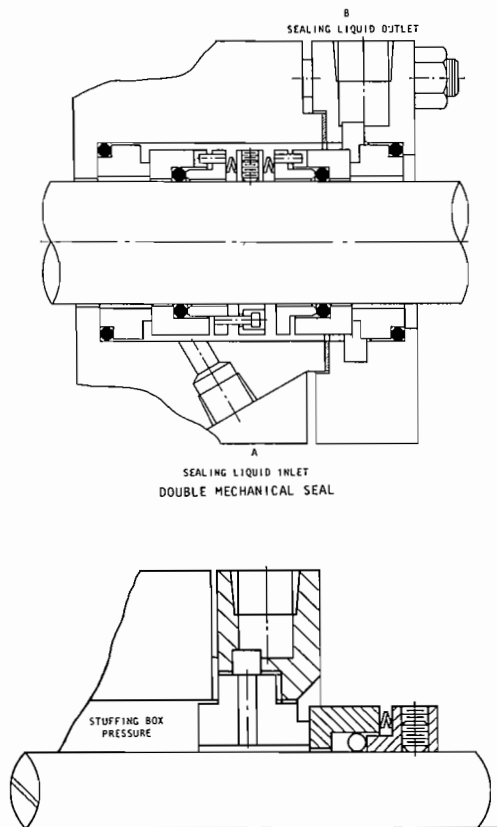

Figure 9. Mechanical Seals.

compatible rotating surface; the remaining springs and secondary seals are external to the stuffing box.

The stationary face is clamped between the stuffing box face and the gland. Flat gaskets on both sides of the face isolate the gland from the corrosive stuffing box fluid. If external flush is used, the gland could be metallic as the process fluid will not come into contact with the gland. Since most applications require produce flush, the gland is a composite material for corrosion resistance.

The rotating member of the seal is positively set on the pump sleeve outside the sealing chamber. An elastomeric or PTFE seal excludes contact between the pumpage and any metal parts on the rotating member.

Advantage: Metal seal parts are not in contact with the process fluid.

Disadvantage: Rated for lower operating pressures (not an issue for most seals applied to composite pumps).

When mechanical seals are used, the sealing environment must be controlled. A flush must always be used to cool the seal and to keep abrasives away from the seal faces. A wide array of API/ANSI piping plans in both metallic and nonmetallic materials are all usually offered.

It is recommended that a seal guard be employed with outside seals to help contain parts if failure occurs.

Single Inside Mechanical Seals

Single inside mechanical seals are the most common type of seals used. The materials of construction of all the seal materials inside the stuffing box must be selected for corrosion resistance in the process fluid.

Advantage: Largest number of designs available.

Disadvantage: Metal parts are in contact with the process fluid.

Double Inside Mechanical Seals

In cases when the process fluid is not compatible with a single mechanical seal, a double seal is employed. Examples include toxic liquids whose leakage into the environment would be hazardous, liquids with suspended solids would rapidly wear the faces, or corrosive liquids requiring seals made of costly materials.

Double seals should be of the "back-to-back" variety. A typical double back-to-back seal installation is illustrated in Figure 9. A compatible liquid, usually water, is injected into the seal at point A and exists at point B. The liquid, called the barrier or buffer fluid, must be maintained at a higher pressure than that of the stuffing box. The buffer fluid also acts as a lubricant on both sets of seal faces and as a means of carrying away heat generated by friction. The inboard seal keeps the buffer fluid from the product and the outboard seal keeps the buffer fluid from the atmosphere. All of the metal parts of the seal are in the buffer fluid only.

The buffer fluid can be either an external flush with a controlled drain (API/ANSI Seal Flush Piping Plan 54) or a closed loop system utilizing a pressurized seal pot (API Seal Flush Piping Plan 53).

Advantage: Prevents process fluid from entering environment. More controlled sealing environment. Metal parts are not in contact with the process fluid. Higher operating pressures can be obtained.

Disadvantage: Requires an external flush or pressurized buffer system. Higher cost.

Cartridge Mechanical Seals

Single, double, and tandem cartridge mechanical seals are supplied as a single unit with the gland and shaft sleeve. This seal is mounted directly on the pump shaft or sleeve. The major benefit of the seal is that it does not require the usual seal setting measurements.

Advantage: Design allows setting of seal after pump assembly.

Disadvantage: Metal parts are in contact with the process fluid. Some stuffing boxes are too small.

Other Components

Casings and impellers, support heads for thermoplastic pumps. Containment shells for magnetic drive pumps. Support column, bearing holders and mounting plates for vertical wet pit pumps (Figure 10).

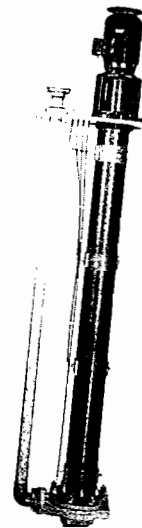

Figure 10. Vertical Immersion Pump.

Standards for Composite Pumps

To enable the users to purchase flanged composite pumps to a standard similar to ASME/ANSI B73.1M metal pumps, a draft for composite pumps is being reviewed. This proposed standard would be ASTM/ANSI B73.5. It will have the following specifications as B73.M.

- Envelope dimensional interchangeability
- Shaft deflection requirements
- Bearing life requirements
- Seal chamber requirements
- Same balance

It will differ from B73.1M by:

- The basic working pressure will be from 100 to 275 psi, depending on the size of the pump.
- The nozzle flanges will be to 150 lb dimensions, but not rating.
- The hydrostatic pressure factor above working pressure will depend on the size, speed and manufacturing process.
- The limiting temperature will be 250°F with mild corrosive liquids. The pressure-temperature limit will be based on a manufacturer-user agreement for the liquid and its concentration.
- The specification can be applied to thermoplastics or thermosets.
- The casing, cover and gland will have a minimum corrosion allowance of two years.

INSTALLATION, OPERATION, AND MAINTENANCE AWARENESS

- If a nonmetallic pump is being connected to metal pipes, expansion joints are recommended to reduce nozzle strain. If nonmetallic pipe and pump of similar modulus of elasticity are being used, then expansion may not be required.
- If packing is being used in a nonmetallic casing cover, external cooling to the packing is required, since the insulating properties of the nonmetallic cover will not allow conduction of the heat, as occurred in metal covers. Packing leakage should be 40 to 60 drops per minute.
- When metal shafts are being used, in vertical wet pit pumps, axial thermal expansion should be accounted for with long shafts.
- PTFE bearings of vertical wet pit pumps have to be continuously cooled PTFE bearings. If not, the PTFE expands and seizes the shaft.
- Nonmetallic flanges are the same dimensions as metal flanges, but not the same rating. Most bolt torque should be limited to 30 to 40 ft-lb. Metal washers should be used under the bolt heads and nuts. Bolting should be torqued by the manufacturer's recommended progression sequence.
- Flange gaskets should be a minimum thickness of 0.125 in with a durometer hardness of 40 to 70. Raised face flanges should not be used as a mating flange.
- Casing bolting should be limited in torque, as specified by the manufacturer.
- $NPSH_R$ is established using three percent head loss as a criteria in the same manner as for metallic pumps. However, it should be recognized that pumps operating at three percent drop in head or relatively close to this will operate in incipient cavitation. Although damage might not be apparent in metallic pumps, it will

be observed after a period on nonmetallic impellers. It is, therefore, suggested that the $NPSH_R$ offered by the manufacturer should be three to five ft higher than that for an equivalent metallic pump.

- Composite pump casings operating at shutoff or very low flow, will heat up internally quicker than metallic pumps because of the insulating properties of the composite. This can lead to quicker vaporization.
- Do not steam pressurize composite pumps. This can cause components to be pressurized beyond intended pressure-temperature ratings.
- A strap wrench or special bolts may be required to remove impellers to prevent damage. Refer to the manufacturer's manual.
- Outside mechanical seals should be protected with a seal guard.

DISADVANTAGES OF COMPOSITES

- Limit temperature to 250° to 300°F. Most corrosive fluids are below 250°F. Similar to metals, a pressure-temperature corrosive range should be reviewed for the application.
- Reduction of mechanical properties with increase in temperature is faster than metals.
- Pumps and piping should be protected from impact of possible falling objects.
- The percentage of absorbability can be high, which results in permeation of vapors between a liner and armor in a pipe or pump.
- Reinforced composites can be brittle like cast iron, requiring low tensile strength materials, like PTFE or PVDF, to have backing.

ADVANTAGES OF COMPOSITES

- Resist corrosive atmospheric conditions and do not have to be painted, therefore reduce maintenance.
- Polymers do not gall, preventing shutdown or loss of power.
- Good insulating properties, preventing loss of product heat (hot or cold).
- Eliminate welding of pipe and fitting, prevent loss of corrosion properties or contamination.
- Reduce electronic action and galvanic action. (This can also go in reverse and cause damage.)
- Nonsparking (two percent graphite filler can be added to prevent electrostatic charge on the surfaces—PFA, PTFE, PVDF)
- Nonmagnetic.
- Reduced noise.
- Less vibration.
- Light weight for easy handling, especially vertical wet pit pumps.
- Impellers from six in to 13 in diameter usually do not require balancing, because the residual imbalance, as manufactured, is lower than required to meet ISO 1940 G6.3.
- Due to the vast range of chemicals, some of the composites can handle, less inventory of materials is needed, eliminating the chances of mis-application. With proper flushing, a pump can be interchanged from a 175°F caustic to 70 percent sulfuric acid system.
- Since composites do not corrode, the impeller operating clearance or ring clearance will not be changed, as occurs in metal components; therefore, there can be longer intervals between planned maintenance of pump performance. Normal corrosion

rate of 0.002 in./year may require casing replacement of a metal pump in six years. The wear rate of the composite will give longer life.

• Initial costs of composite pumps will be equal or less than comparable 316 stainless steel horizontal pumps. On vertical wet pit pumps, the cost could be 30 to 50 percent less.

DISCLAIMER

These data and notes are for use as general guidance. No recommendations are intended as a guarantee by the author or other sources. Pump manufacturers and material suppliers will or can supply application information

REFERENCES

1. Margus, Edward "Choosing Thermoplastic Pumps," Chemical Engineering, New York, New York: McGraw Hill (1991).
2. Fusco, Joseph, "Plastics Developments Advance Pipe Performance and Safety," Chemical Processing (December 1990).

3. Karassik, Igor J., *Pump Handbook*, Second Edition, New York, New York: McGraw Hill.
4. Wilhelmi, George F., "Composite Materials for Ship Machinery Applications," Society of Marine Architects and Marine Engineers.
5. Buse, Frederic W., "Nonmetallic Pumps," World Pumps, Elsevier, Science Publisher, Ltd. Survey SM4 SEW, England (May 1989).

ACKNOWLEDGEMENTS

The author wishes to acknowledge the following manufacturers of composite pumps for their assistance and technical contribution for portions of data, charts, tables and photos used in the writeup and tutorial presentation: Fibroc, Duriron, Gorman Rupp Pumps, IMO, Warren Pump Co., and Ingersoll-Dresser Pump Co.