

SINGLE PLANE BALANCING

by

Charles Jackson

Turbomachinery Consultant

Charles Jackson, P.E.

Texas City, Texas

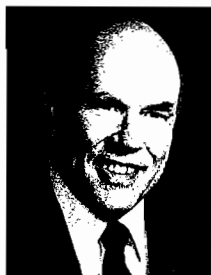

Mr. Charles Jackson is a licensed Turbomachinery Consultant and owner of Charles Jackson, P.E., founded January 1986, after serving 35 years for Monsanto Company, retiring as a Distinguished Fellow in Corporate Engineering while reporting to St. Louis. He is a Charter Founder and Advisory Committeeman of the Texas A&M Turbomachinery Symposium, a Charter Director and Lecturer of the Vibration Institute, and an ASME Fellow. He is the first recipient of ASME's Frederick

P. Smarro Award in Plant Engineering & Maintenance, ASME Allan J. Chapman Award, ASME's Petroleum Division's "Oil Drop" Award, and received a Texas A&M Distinguished Alumni Award in Engineering in 1990. He served the API Subcommittee for Mechanical Equipment for over 22 years.

He has a BSME degree from Texas A&M University and a AAS degree in Electronics Technology from College of the Mainland. He is a Member of ASME, Vibration Institute, Tau Beta Pi, and Pi Tau Sigma. He has published over 75 technical papers and is the author of one book, The Practical Vibration Primer.

ABSTRACT

Balancing rotating equipment is a form of correction for things that were either not uniform in material sciences or in assembly of components on a rotating shaft. The single plane balancing procedures are addressed, wherein one substitutes a corrective mass moment to compensate for these nonuniform distributions of imbalance.

The approach to be used concentrates in several areas. The first area is the vibration sensors and related instrumentation. The next area is the response of a rotor as it runs up to operating speeds, with some introduction to the mode shapes involved. The third area is the plotting of data, specifically the polar plot, to give the balancer some insight on the "heavy spot" vs "high spot" relationship. Fourth, the balancing procedures creating a response vector (T) from a calibration or trial weight and shifting that vector to effectively cancel the "original" vector, resulting in smooth 1x synchronous motion are discussed. The fifth area is the calculation of the correcting influence coefficient in terms of a weight (or moment) vector unit per vibration unit with an "additive" angle to affect a future "one shot correction." Finally, some other single plane techniques are discussed—balancing with the coupling's original residual unbalance, balancing without phase information, introduction of static-couple vector logic, and the review of some of the industry balancing standards.

The tutorial will, in fact, take a "balanced rotor," unbalance it, plot its runup, determine a correction, vectorially, and plot the result. Multiple plane balancing will not be reviewed herein, primarily because of timing and the addition of three other vector-triangle relationships.

INTRODUCTION

At one time, I considered pumps as small, but the last boiler feed pumps that I worked on were 17,000 hp each of ten. So balancing is probably in order for a tutorial.

Several main subject areas are presented. These subject areas are discussed in brief, using the written material for deeper review. This allows for a complete single plane balance to be performed via actual demonstration with rotor, scope, tracking filter, and overhead transparency plotter. The subject matter has been arranged in these main categories to assist one when scanning the information presented:

- The vibration sensors and instrumentation to be used in balancing.
- The phase logic which is so important to successful trial shots in balancing.
- "Heavy spot" and "high spot" logic during rotor runup through criticals.
- The actual balancing procedure—records, vectors, plotting, and calculations.
- Other single plane techniques, plus some balancing specifications.

INSTRUMENTATION

The instrumentation to be used in balancing has a major effect on how the data is to be used. The instrumentation used should benefit the balancing. The choice of the proper sensor may well come from experience, yours or someone you trust. For example, a large induced-draft fan setting on top a boiler will generally lend itself to seismic measure on the bearing housing, because the housing and the shaft are moving together and the force coming through the bearing housing has high transmissibility. A motor and pump, with rolling element bearings, will be balanced best using seismic sensors. For many machines, however, the better measure would be direct from the shaft with some form of displacement sensor. *No matter which sensor is used, some form of phase measure is necessary, in order to do balancing—field (in situ) or shop.* The focus herein is on field balancing and on phase measurement, even to the point that it emphasizes phase enhancements, i.e., the *polar plot*.

It is illustrated in Figure 1 that there are many units used for vibration measurements. Unfortunately, these units are not well understood, i.e., an accelerometer may have been calibrated in "g's rms," and the user is checking calibration using an oscilloscope which is looking at peak-to-peak (p/p) voltage. Now, it may be that things are nearly 3:1 out of calibration; actually, not so only 2.828:1 apparent disagreement since 1.0 g rms is equal to 2.828 g p/p.

One should recognize that there are instrument lags and mechanical transmissibility lags. The lower part of Figure 1 is trying to show that velocity leads displacement by 90 degrees, and acceleration leads velocity by 90 degrees. If the instrument supplier makes a 90 degree correction, when integrating velocity to displacement, then, one may (or may not) be in the same phase

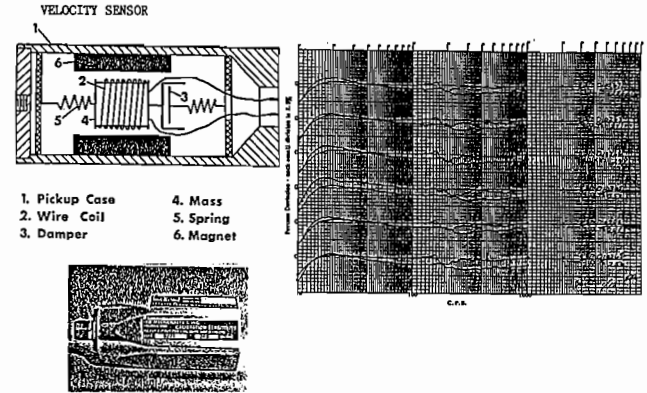
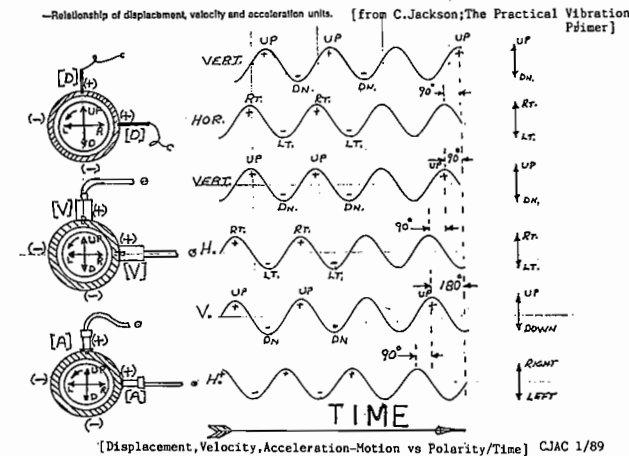
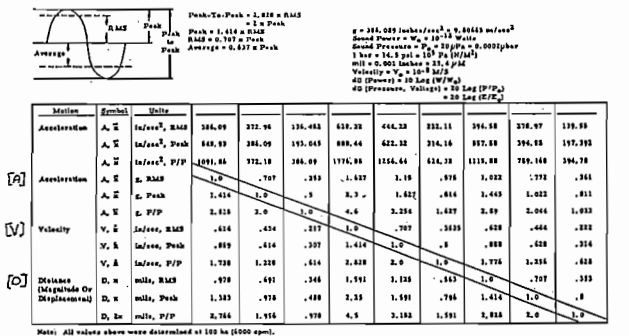

Figure 1. Relationships of Displacement, Velocity, Acceleration, and Sensors.

VELOCITY SENSOR/DEVIATIONS VS FREQUENCY (Courtesy of IRD Mechanicals)

Figure 2. Characteristics of a Specific Velocity Sensor.

logic with displacement. In Figure 1, a displacement signal of shaft motion relative to bearing housing is shown vs absolute bearing housing relative to space, via velocity seismic sensor, vs the same absolute bearing housing motion, via an accelerometer (permanent API 678 seismic monitoring uses the accelerometer because of sensor life in continuous measure).

I have always thought of the seismic (e.g., velocity sensor) as sensing the "heavy spot," since it responds to force (heavy not high), and the displacement sensor as sensing the "high spot" (not heavy).

The calibration of an IRD 544 velocity sensor up to 60,000 cpm (1000 Hz) is shown in Figure 2. Note that the amplitude rolls off starting around 900 cpm (15 Hz) as that sensor approaches its own resonance, for which it is damped internally. This sensor is shown first, as it is used the most and has been around the longest. It is self-generating and puts out a strong signal on the order of 1.0 volt/in/sec (ips). Some characteristics are shown. One characteristic, important to balancing, is that the phase lag increases as the speed becomes less than two pole speed. A smart balancer knows this and can make compensation in placing trial weights, e.g., if the speed was 900 rpm, then the balancer would know that the "lag" had increased by 60 degrees. This deviation in lag is shown in Figure 3.

Again, phase must be used in some form in balancing. Adjusting the spark advance or retard in timing an automobile (circa 1970) is related in Figure 3. The #1 plug was used, and the flywheel had inscriptions in degrees to allow one to rotate the carburetor to adjust "lead" or "lag" in ignition. The strobe-light-fired vibration (balancing) analyzer may use a similar system; but, instead of the number one plug, it takes a "pulse" of the negative-to-positive crossover signal from the vibration sensor to "fire" the strobe light, which must be tuned exactly to speed based on the same vibration sensor. This freezes a reference mark on the rotating shaft. By rotating the shaft, at rest, to the same position where the "reference

mark" was frozen, one can index the shaft's position to the vibration signal information. This allows one to relate the shaft's motion to the vibration signal via this phase reference.

The way that specific system works is shown in Figure 4. In the top, the contact that is activated on the strobe light is connected to a channel on the scope. The first channel on the scope shows the vibration signal from that specific vibration sensor. One can see that this crossover (within some small flash angle) is at the minus-plus going signal. [Note: on some other analyzer, it may be (+) to (-) going signal or some other position which one should learn.] In the lower part of Figure 4, this particular analyzer is illustrated with a velocity sensor at 3:00, freezing a heavy spot (#) at 12:00, operating in displacement (integrating) for a 90 degree lag against CW rotation or a 270 degree lead with rotation, from the vibration sensor. This position will be frozen by the strobe light using the same instrument, at the same speed, with the same unbalance position, with the same sensor, in the same location each time the machine is brought up to that speed, when properly tuned. A reference mark (on the shaft) is frozen, against rotation, at a 315 degree position. If a trial weight is placed at 180 degrees from the sensor, against rotation, then the new heavy spot is somewhere between 90 and 180 degrees, and for illustration purposes, say each is equal in value, causing a new heavy spot at 135 degrees from the sensor (45 degrees lagging from previous heavy spot). When the machine is brought up to speed, the new heavy spot will assume the 90 degree position, causing an increase in lag (advance in the reference mark with rotation) by 45 degrees. Conclusion: for this particular instrument, a trial weight placed to the "left" of the original unbalance caused a move to the "right" by the reference mark. (This is not true of many instruments using a once-per-turn "phasor" reference on the shaft and a dedicated sensor to indicate from that "pulse" for phase triggering.) Further, it is not the logic of the demonstration that will follow, nor the plotting logic on the vector chart. However, those using that system would shift the trial weight accordingly, i.e., opposite the example.

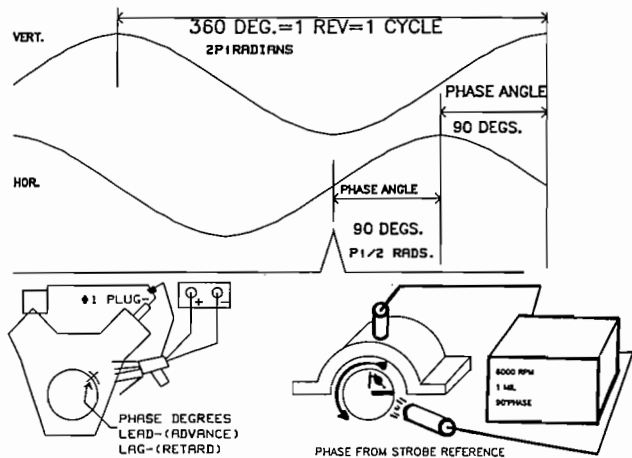
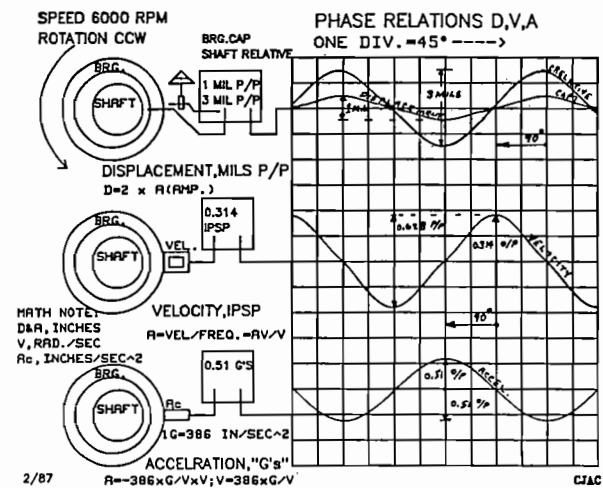

STROBE SYSTEM FROM VELOCITY SENSOR
EXAMPLE: BALANCING PHASE LOGIC

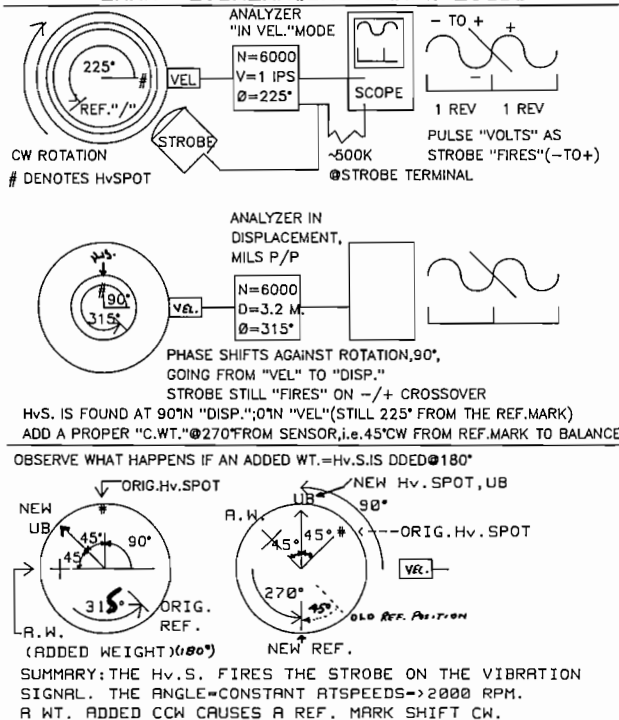
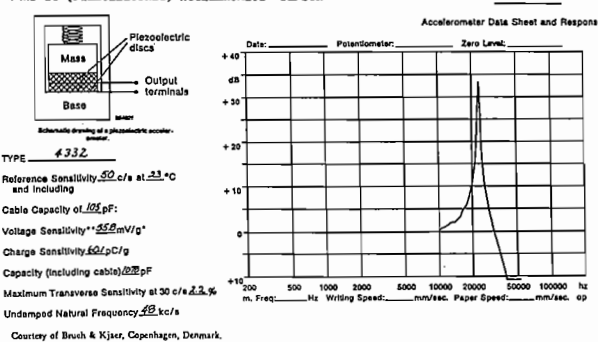

Figure 4. Phase Relationship with Strobe System and Velocity Sensor.

SEISMIC (PIEZOELECTRIC) ACCELEROMETER SENSOR



- Piezoelectric Seismic Sensor (The Practical Vibration Primer/Jackson)
- Supply Voltage: Typical 10 to 24 VDC
 Output Voltage: 10 mv/g; 25 mv/g; 100 mv/g
 Above Sensor= 55.8 mv/g and uses separate charge amplifier (good over 350 °F.)
 Machinery Sensor: 100 mv/g with internal impedance matched amplifier (< 350 °F.)
 Frequency Response Range: 5 Hz to 10 KHz
 Size: 2 grams to 50 grams; The larger the accelerometer the lower the freq. range
 Mounting: Stud and cement-1/4"-28 w/epoxy
 Uses: Bearing cap measure
 Gear Mesh Frequencies-high
 Base frequencies
 Piping and Sonic Frequencies
 Blade resonance measure
 Structural born noise-torsionals, ball pass races, cracks, etc.
 Construction: Good encasement. Good protection from RF & induced magnetic interference, e.g. electric motors.
 In Balancing: Responds to force, "heavy spot". Very effective in tight places.
- Disadvantages:
 1. Requires voltage to operate.
 2. Output voltage is low.
 3. Marginal for low frequencies.
 4. Mounting is extremely important.
 5. Low Pass Filter required as the sensor's resonance is excited.
 6. Noise, e.g. cable rub, can be bad.
 7. Fairly high cost. (>\$500)
 8. Cables are small & fragile.
 9. Easy to damage in the field.
 10. Sensitive to environment-temp.
- Balancing: Acceleration signal is generally 180 degrees leading displacement signal and 90 degrees leading velocity.

Figure 5. Characteristics of a Piezoelectric Accelerometer.

The characteristics of a particular accelerometer are shown in Figure 5. It has a resonance at a higher frequency, hopefully two to five times the frequency of interest. It is passive and needs power to operate. It is a piezoelectric crystal sensor. It is used in many

permanent monitors for seismic (API 678) measurement. Some recommended mountings per C. Jackson and the API are shown in Figure 6. Integrated amplifiers are recommended for temperatures

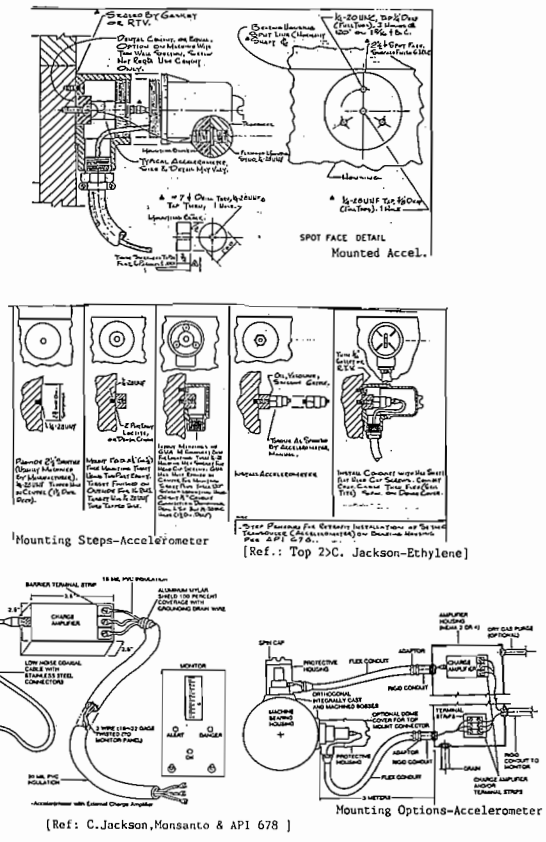

Figure 6. Mounting of Accelerometers—Jackson and API 678.

under 250°F to 300°F, preventing cable noise and problems in amplification for transmission.

The eddy current displacement sensor, which is standard in API 670 for vibration measure, is shown in Figure 7. It is a passive device and requires -24 VDC to power the system. It has an 80 mil minimum linear range and a sensitivity of 200 mv/mil. It measures the "high spot." It does not measure the "heavy spot." A logic can be applied, and will be applied in this tutorial, of the "heavy spot" vs "high spot" relationship.

Figure 8 is also taken from API 670, and shows the typical arrangement as well as the identification system within a machinery train. Some of the instrumentation used for diagnostics are shown in Figure 9, as well as some for balancing. Orbit and timewave data possible from a synchronous tracking filter, both "raw" and "filtered," are shown shown in Figure 10. The proper orientation of two sensors is shown in Figure 11, placed y and x on a rotating shaft, with the horizontal sensor always placed 90 degrees to the right of the vertical sensor, as viewed, regardless of the direction of rotation. The (plus up) and (plus right) logic of data taking is very important. Further, the API, in order to get common agreement, dictated that the 45 degrees off the vertical centerline be used in placing permanent sensors on an operating train, which pleased the turbine builders and embittered the rest. The phase angle is measured as the angle against time (or rotation) from the moment the phase sensor sees the once-per-turn rotor mark until the next positive (+) peak occurs.

Since the positive peak comes later in time, one needs only to reference the rotor to the data taken, i.e., line up the reference mark on the shaft to the triggering position of its sensor, in the direction of rotation, and move back against time (rotation) to locate the "high spot" at that *specific moment in rotation (time)*.

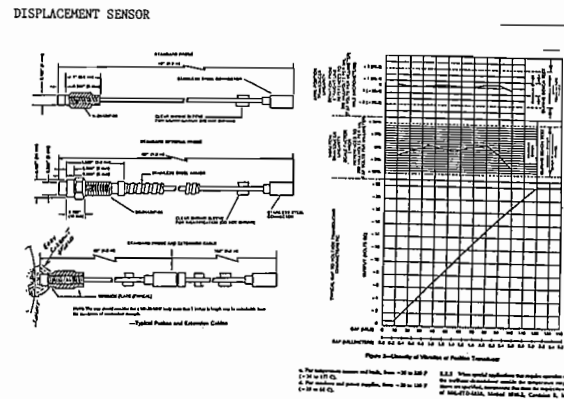

Displacement Sensor (Ref. API 670 Standard for Unification)

Supply Voltage: -24 VDC
 Output Voltage: Approx. -1 to -18 VDC
 Voltage Sensitivity: 200 mv/mil
 : 8 mv/micro-metre
 Frequency Response Range: zero to 2 KHz (usable frequency) : zero to 120 Kcpm
 Temperature Range: 250 °F. w/o offset
 Size: 190 to 300 mm bodies (tip diameters)
 Cost: ~\$100.00 w/o oscillator-demodulator
 Mounting: Rigid or "Seismic" Mounting
 Construction: Threaded Body (1/4 or 3/8" NF)
 Internal coil-epoxy, ceramic, glass, etc.
 Body Holders: Adjustable threaded sleeves,
 Uses: Radial Vibration, 40 mils p/p
 Axial Position, +/- 40 mils range (80+).
 Journal/Bearing eccentricity measure.
 Rotor Growth, one inch range.
 Alignment Dynamic Measure, 1/4" range.
 Phase "Once-per-turn" Triggering
 Tachometer Input Signals
 FM Torsional Measure-Torque & Resonance
 In Balancing: Measures "Shaft High Spot" In Balancing: Does not recognize "heavy spot"-knows "high spot".

Disadvantages:
 1. Sensitive to electrical runout.
 2. Output voltage varies with rotor material conductivity changes.
 3. Sensor holders can be resonant. Longer length should use guides.
 4. Inner coil material encapsulant can be penetrated by certain chemical compounds, e.g. NH₃OH.
 5. Requires electric power-passive.
 6. Long signal cable runs can have RF induction.
 7. Cost of sensor + driver @ \$500.
 8. Displacement signal at high frequencies is very low.

Figure 7. Characteristics of Eddy Current Proximity Sensors.

The "orbit" is a locus of the high spots of a rotor (Figure 12). The triggering only freezes the shaft at a "moment in time." The resonance of a rotor (critical speed) is the point in speed where the shaft deflection time, its stiffness is in force equilibrium with the unbalance force, mass/time eccentricity times square of the speed. At this moment, the heavy spot will continue "forward with rotation" until the rotor is now whirling about its true line of mass centers, i.e., heavy spot is now inside the rotational axis.

The polar plot is shown in Figure 13. It takes only one sensor to make a polar plot. It takes two sensors to make an orbit. The polar plot is very similar to a Bodé plot, but it emphasizes the phase angle, which is very significant in balancing. The polar plot of the large turbine at the bottom had its high spot and heavy spot together at low speed, with a high spot of 90 degrees, against rotation from the vibration sensor. After the rotor went through its first critical (resonance) at about 2,150 cpm (rpm), or phase lag of 90 degrees, 90 degrees + 90 degrees = 180 degrees, it reached operating speed with a phase angle of about 308 degrees. Since, at this speed of 3,800 rpm, the high spot and heavy spot are out of phase by 180 degrees, and since the high spot is 308 degrees, one would use a trial weight placed at the high spot (308 degrees against rotation from this vibration sensor). More on this in Figure 14.

A four part look at a rotor coming to speed is shown in Figure 14, and five speed ranges are shown to grasp what is happening. The whole logic of weight placement in the correct quadrant of the rotor is shown in this diagram. The placement of trial weights on/off a rotor should not be arbitrary. There is a logic to that process, and every balancer uses that logic, but it may not be too well organized. It is hoped that this presentation will resolve that logic. The demonstrated balance in the plotted data, and in the demonstration, will nearly duplicate this diagram.

The top data are taken at very low speeds, where the high spot and heavy spot are together; i.e., there is not enough speed for the

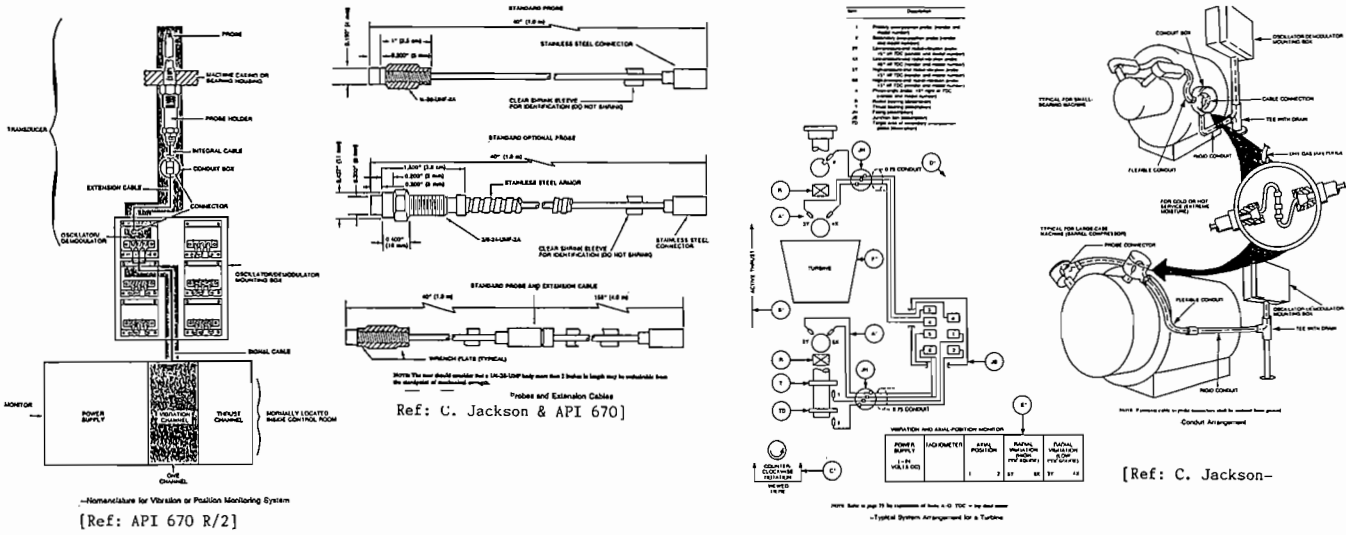

Proximity Probe System Circuit, Calibration, Sizes, & Motion Logic

Figure 8. Mounting of Proximity Sensors on Machinery.

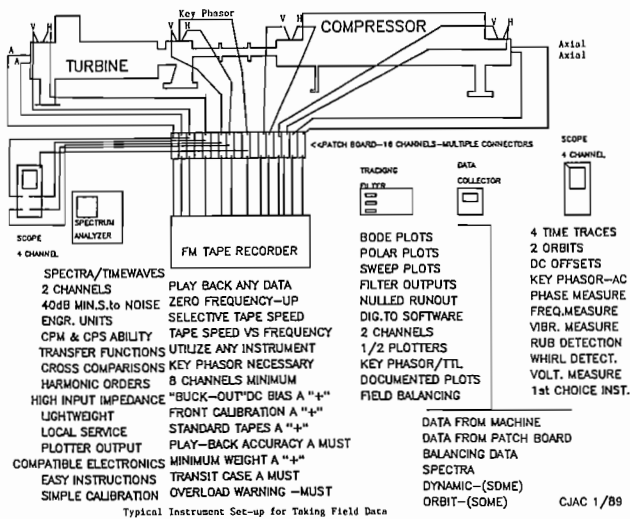

Figure 9. Typical Instrument Setup for Taking Field Data.

heavy spot to begin to go forward in rotation, nor the vibration response to lag the force. The next speed is slightly faster, where the high spot starts to lag back from the heavy spot (force). The middle speed is right on top of resonance; here the high spot has lagged 90 degrees from the heavy spot, and the force has deflected the rotor to its maximum position. The next speed is basically off the peak of the resonance response envelope. The final speed, lowest data, is well above the resonant speed. Here the high spot has lagged back from the heavy spot by exactly 180 degrees. Said another way, the vibration response has now lagged the force by 180 degrees.

The first column shows the physical relationship of the heavy spot, which stays the same, and the five different positions of the high spot at the speed increments as their lag angles increase, against rotation. The second column shows the force vs response vectors. The vibration (high spot) must always lag the force (heavy spot). Furthermore, there must be a force first and a response later. The third column shows the interrupted polar plot at each speed

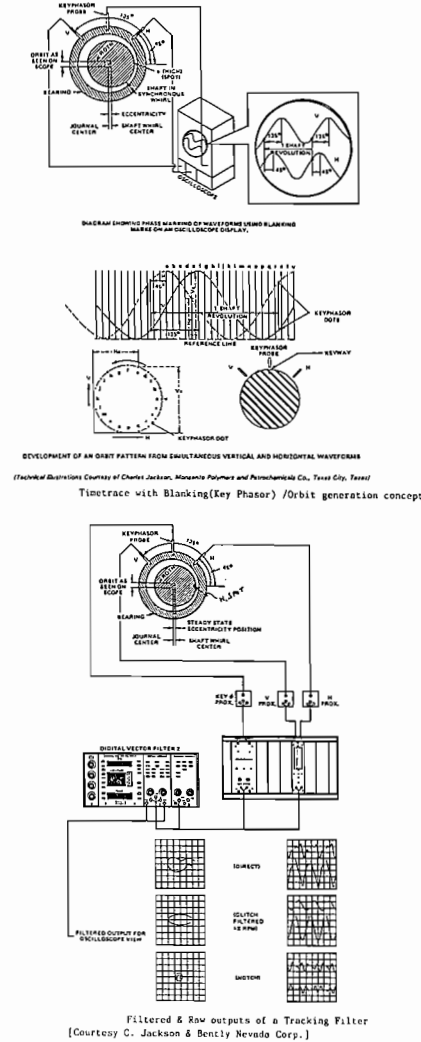

Figure 10. Proximity Signals to Scope and through Tracking Filter.

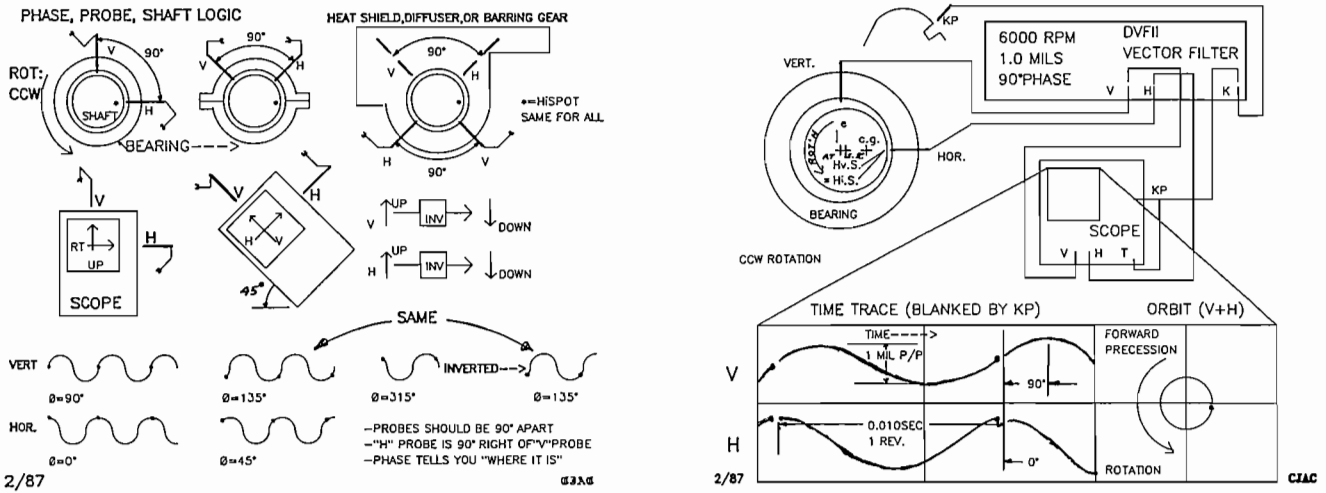
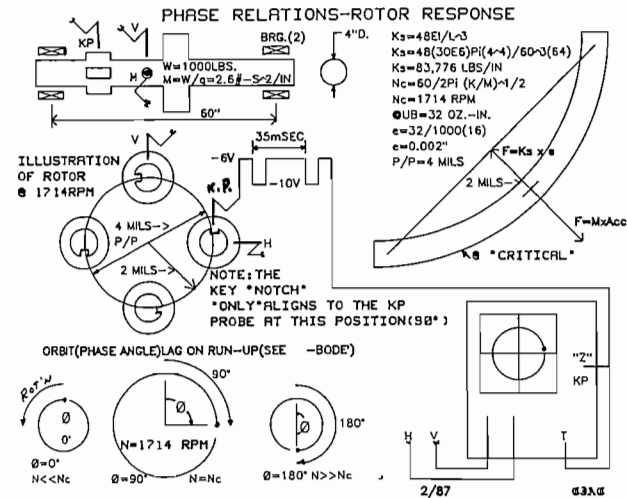
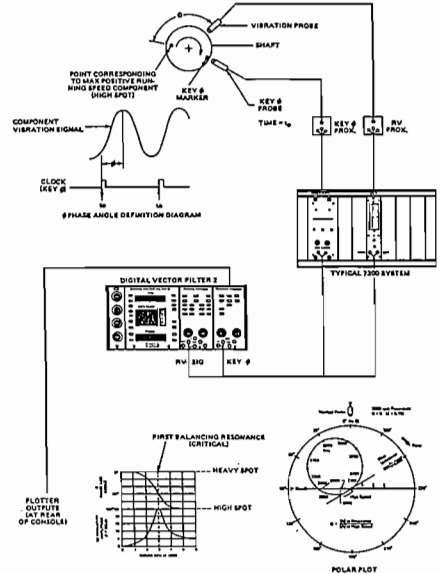
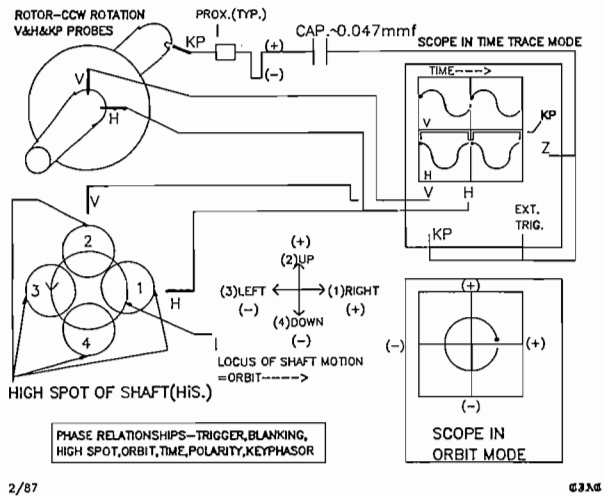

Figure 11. Phase Relationships Scope, Orbit, Timebase, and High Spot.



Bode & Polar Outputs from a Tracking Filter (BNC's DVF-2 or 3) [Courtesy Bently Nevada Corp.]

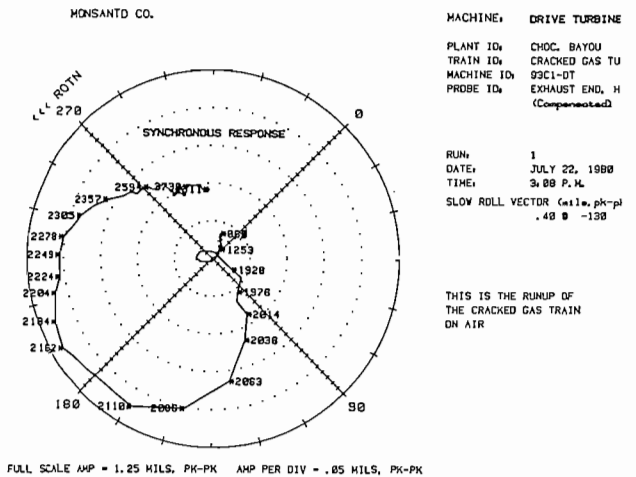

Figure 12. Phase Relationships, Orbit, Timebase, Keyphasor, and Critical.

Figure 13. Polar Plots and Bode Plots from Tracking Filter.

PHYSICAL, FORCE/RESPONSE, POLAR, BODE' EFFECTS GOING THRU A CRITICAL

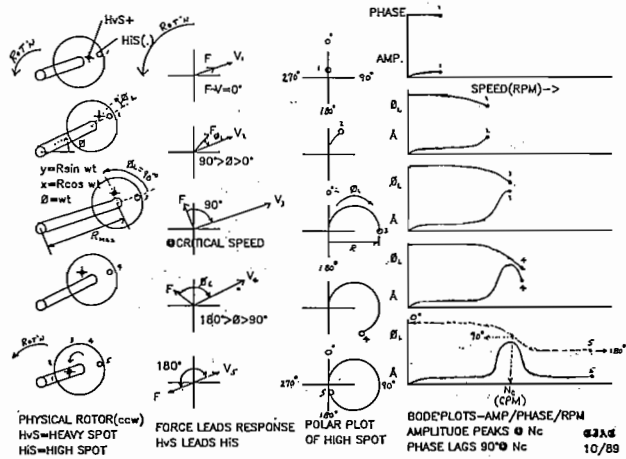

Figure 14. Physical Force/Response, Polar Bode Effects Going Through a Critical.

interval. The last column shows the interrupted Bode plot at each speed interval. [This same logic can carry into multiple plane, above other resonances, and is carried out in the Vibration Institute at advanced balancing—not in this exercise.]

Note: When using displacement probes, in particular, it is important to confirm that the measurement planes and the weight add planes are on the same side of a rotor's nodal point! (For correct logic.)

THE SINGLE PLANE BALANCING RUN

Description

The single mass rotor model can be seen in Figure 15. A single mass disc at 1.804 lb (818 gm) is supported on a 3/8 in diameter shaft between bearings on 16 in centers. Two eddy current proximity probes are mounted 6.0 in to the right of the inboard bearing near the disc, which is 7 3/4 in from the inboard bearing (1/4 in off true center span). The vertical (12:00 o'clock) sensor data will be used to calculate the balancing information. The horizontal (3:00 o'clock) sensor data will be displayed, but not used, in calculating balance data. The top operating speed is 5024 rpm. There is a vertical first resonance at about 2178 cpm, and a horizontal first resonance at about 2524 cpm. A variable speed electrical motor with a speed controller will be used to drive the rotor.

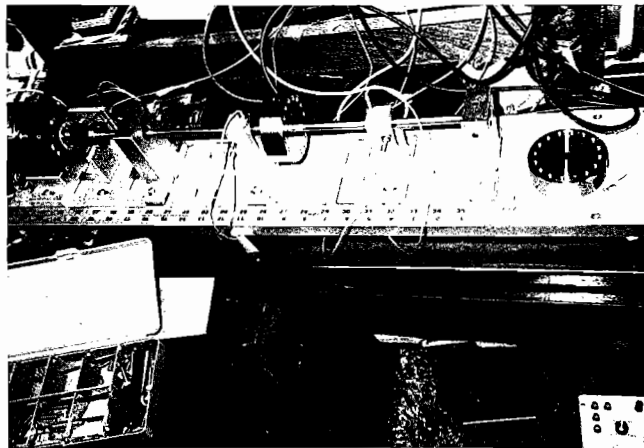

Figure 15. Model Used in Balancing.

A similar mode diagram is shown in Figure 16, but of a shorter span, i.e., higher resonance of 4,188 cpm (but gives one the animated motion of the shaft at resonance).

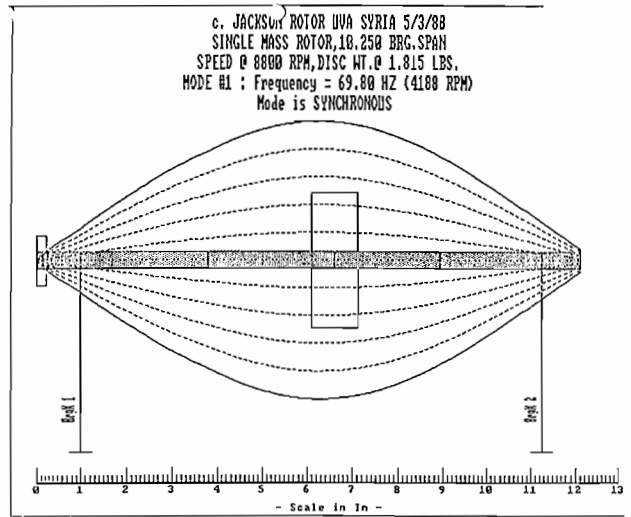
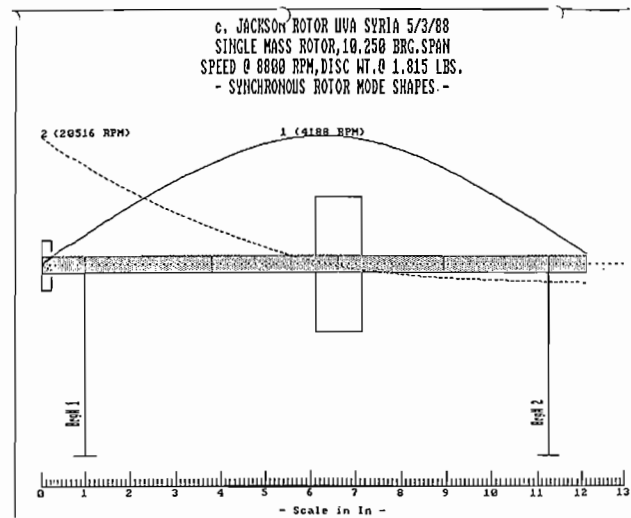

Figure 16. Typical Mode Shapes of (Similar Shorter Span) Single Mass Rotor.

The disc has 16 holes (22.5 degrees apart), tapped at 10 - 32 tpi at 1.2 in from the center. An unbalance weight of 0.46 gm was placed at (0 degrees) #1 hole in line with the vertical sensor, when the once-per-turn notch is in line with the keyphasor sensor. There is some minor residual unbalance in the rotor, but the zero position was purposely selected to duplicated the logic diagram in Figure 14.

Instrumentation

The data will be measured and transmitted from a digital vector filter, which is a menu driven digital instrument (Figure 17). The slow roll data, 0.41 mils p/p at 67 degrees vertical and 0.35 mils p/p at 349 degrees horizontal, are dimly seen on the screen, and the first running value of 2.21 mils p/p at 177 degrees is recorded (vertical). The slow roll values taken at 484 rpm was nulled out for the balancing. The plotting of data was done on an HP 7475 plotter. (As an afterthought, some of the run up data was done, later, to show the orbit and time wave plots for better understanding.)

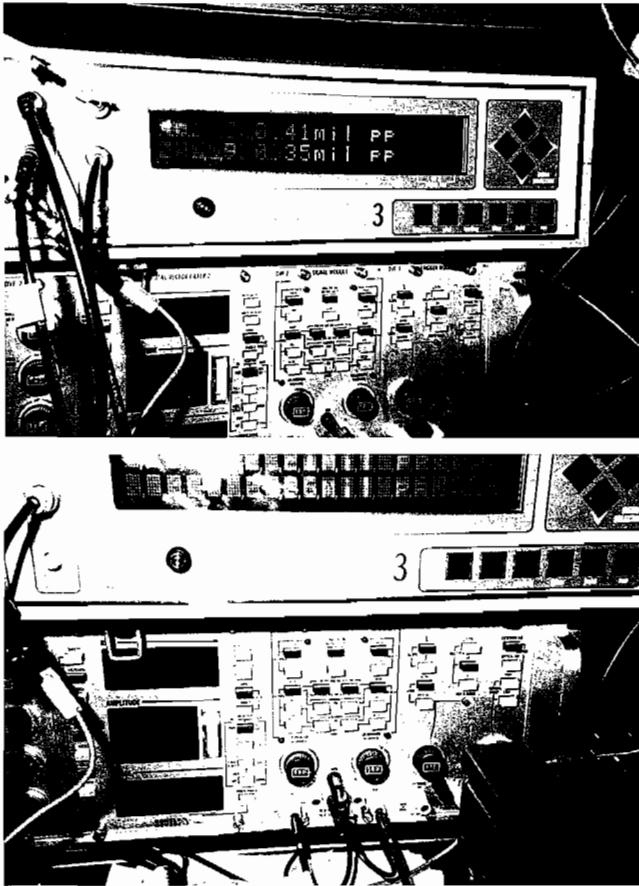

Figure 17. Tracking Filter Used to Take Balancing Data.

Shown in Figures 18 through 21 are the Bodé plots, the orbits at eight different selected speeds, and the orbit vs timewave data at four selected speeds, immediately below first vertical resonance, at first vertical resonance (see Figure 20 lower), at first horizontal resonance (see Figure 21 lower), and well above resonance at 4,946 rpm (Figure 21 upper). Please note the phase difference between the Figure 20 orbit vs time data at 2,178 cpm (rpm) and the Figure 21 data at 4,946 cpm (rpm)...shifted 180 degrees.

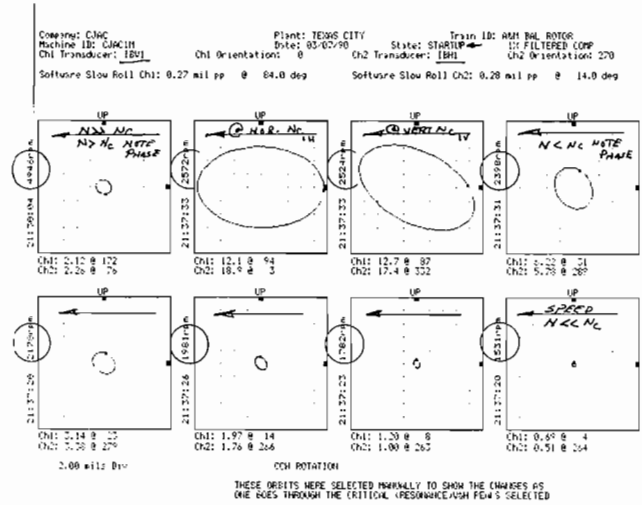

Figure 19. Sequence Orbits Taken from Vertical/Horizontal Sensor on run up at selected speeds.

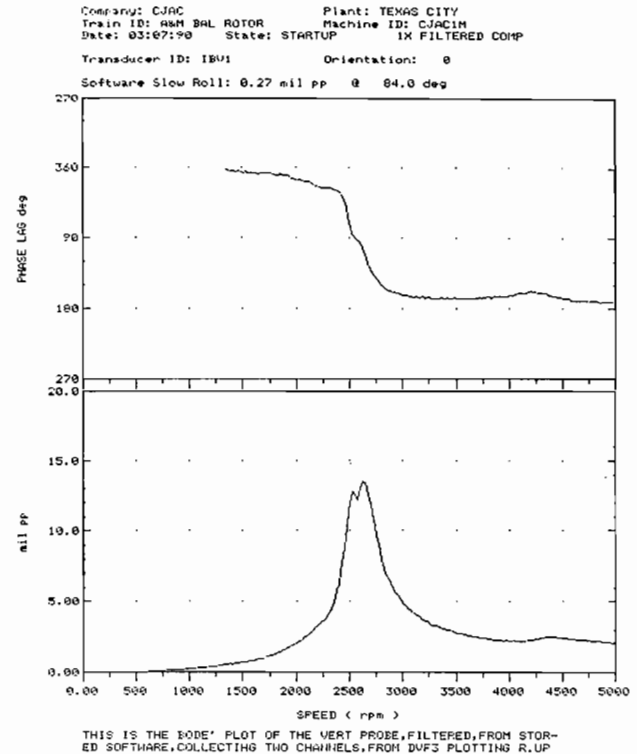
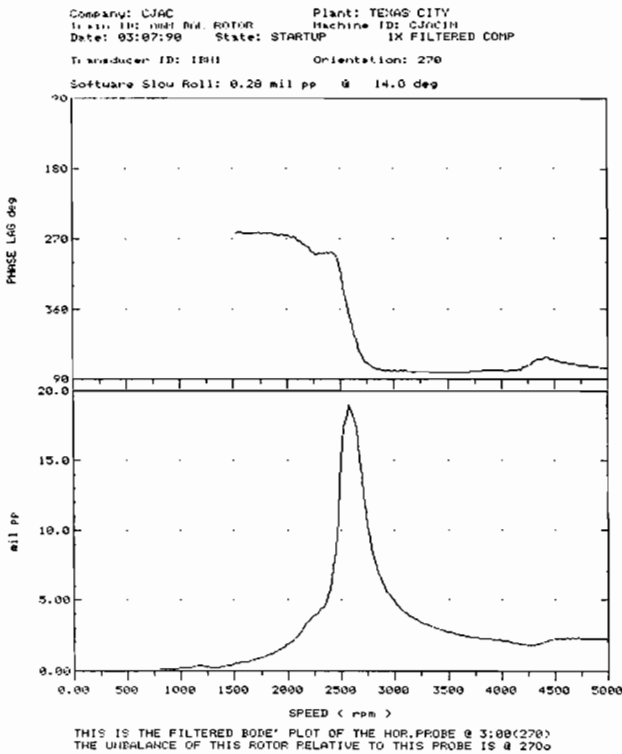

Figure 18. Bodé Plots of Vertical and Horizontal Sensor on Run Up.

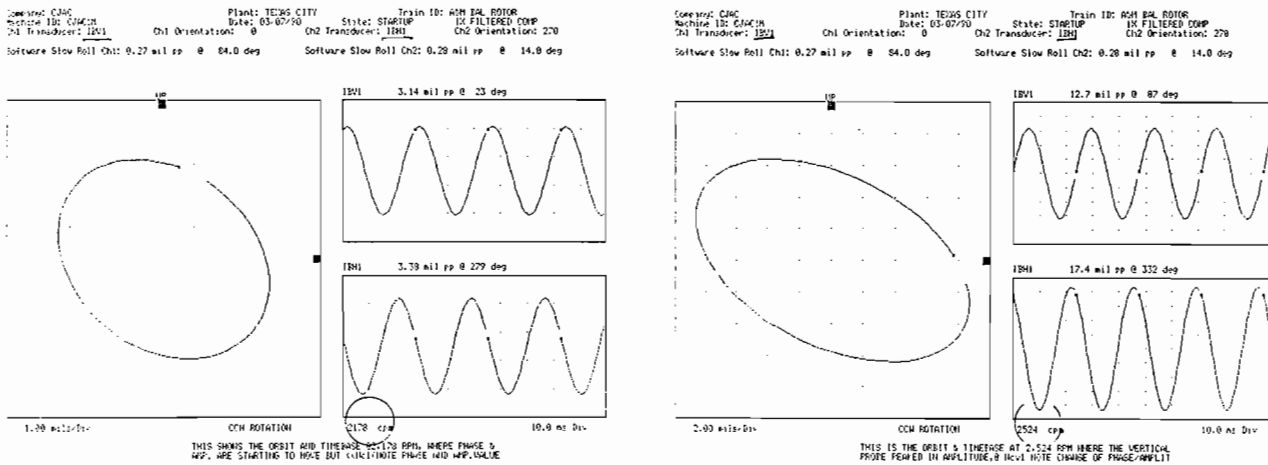

Figure 20. Orbit and Timetraces at 2178 and 2524 RPM (Vertical Critical).

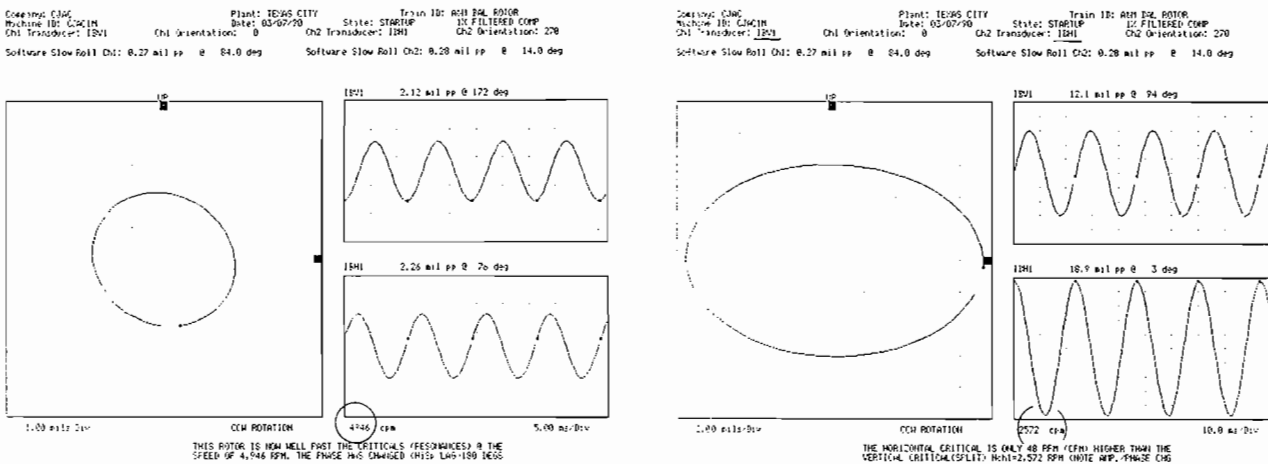

Figure 21. Orbit and Timetraces at 2572 RPM (Horizontal Critical) and 4946 RPM.

Record the Original Data

The original data, at speed 5,024 rpm, are noted on the left vertical polar plot (Figure 22) as 2.21 mils p/p at a phase angle of 177 degrees (high spot), and well above the first resonance of the rotor.

O vector = 2.21 Milis at 177 degrees; record of polar plot Figure 22 (left); record on data sheet Figure 23; plot on vector diagram Figure 24.

Note: Figure 25 is the Bodé plot of both vertical and horizontal sensors for those who may not grasp the polar plot yet. Furthermore, some folks can see the resonance better in their minds from a Bodé plot. There is a slight "split critical" apparent, in that the vertical critical is near the horizontal critical (resonances) but not the exact speed.

SELECT TRIAL WEIGHT LOCATION

Noting the polar plot and the logic discussed, the place to put a trial (calibration) weight would be at 177 degrees. However, in order for the vector plots to make a reasonable triangle, the trial weight will be placed slightly out of desired position so the procedure should make the solution go towards the 177 degree region. The trial weight of 0.5 gm is used (slightly more than known unbalances) and placed at 202.5 degrees rather than where

the logic states, i.e., solution should move the correction weight towards 177 degrees. Record the trial weight on the data sheet. (Note that the vector plot, Figure 24, shows the 0.46 gm used to unbalance this rotor at 0 degrees, Ub; also, the trial weight location, T. W., at 202.5 degrees.)

RERUN THE ROTOR FOR THE 0 + T VECTOR DATA

The rotor with 0.5 gm of weight placed at 202.5 degrees is run—up to the same full speed of 5,024 rpm. The polar plot is shown in Figure 26 with the same 20 mil p/p full scale plot. Note that a good reduction (1/2) of vibration occurs at full speed. The polar plot is very similar, smaller, and slightly askew of the previous plot. This is good, because it satisfies one of the basic rules of balancing: If the vibration goes down, but the phase angle stays the same or changes only slightly, the trial weight is in the right position, but too small.

PLOT THE VECTOR 0 + T (ORIGINAL VECTOR + THE TRIAL WEIGHT EFFECT VECTOR)

0 + T vector = 1.10 mils p/p at 115 degrees; record the data on the data sheet, Figure 23; record the final at speed data on the 0+T

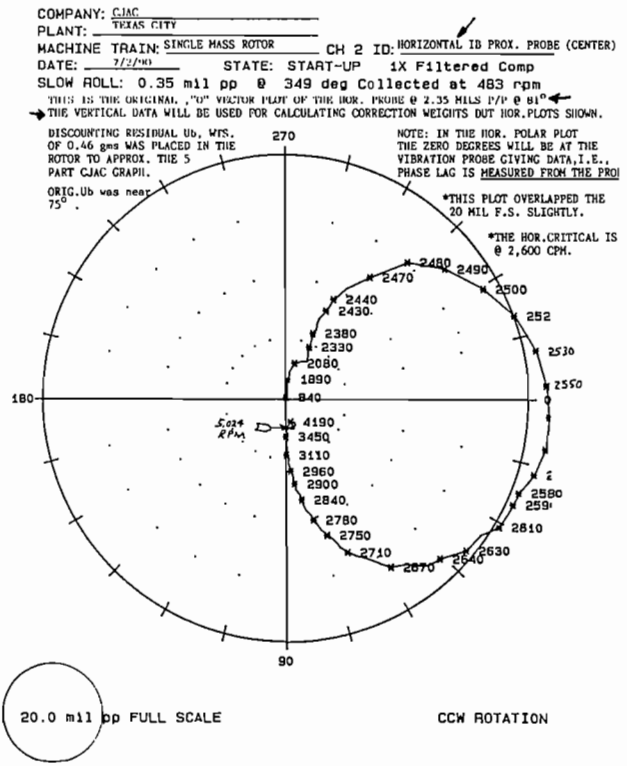
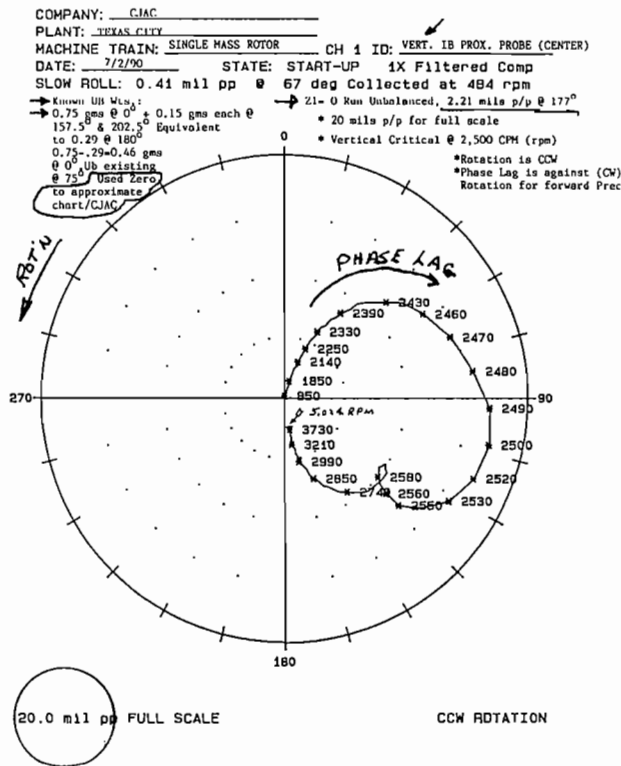

Figure 22. Polar Plots of Vertical (Used to Balance) and Horizontal for 0 Vector to Speed.

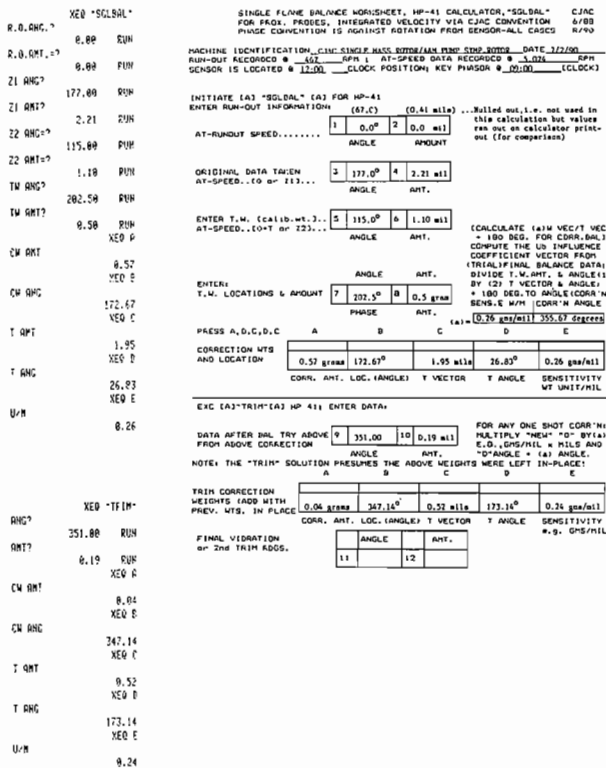

Figure 23. Balance Record Sheet with All Solutions + Calculator Print Out of SGLBAL.

polar plot, Figure 26; plot the 0 + T vector on the vector diagram, Figure 24.

Connect the arrow head of the 0 vector to the arrow head of the 0 + T vector on the vector diagram. Label this vector, T, and place its arrow head at the 0 + T end. (Law of vectors says that heads-to-tails, add, and heads-to-heads, subtract.) So, 0 vector + T vector should equal 0 + T vector. Conversely, 0 + T vector minus T vector should equal 0 vector (0 + T - T = 0) (0 + T = 0 + T).]

WHAT IS THE GAME PLAN AT THIS MOMENT?

(King's X, Tick the Lock, All Around!)

- T vector was caused by adding 0.5 gm at 202.5 degrees.
- The game plan is to make T equal to 0, but in the opposite direction (T = -0).
- Why not translate the T vector to originate at zero on the vector diagram?
- Why not shift the T vector to the -0 vector by shifting the trial weight?
- The 0 vector is 2.21 mils at 177 degrees. The T vector measures 1.95 mils at 27 degrees. T is slightly smaller (0/T = 1.13) than 0 and about 30 degrees out of position.
- If (T) is not as long as (0), why not add weight? How about 13 percent more weight?
- If T needs to move (with rotation) by 30 degrees to lay on (-0), then why not move the trial weight 30 degrees (with rotation) and add 13 percent more weight (1.13 x 0.5 = 0.57 gm).
- If the trial weight of 0.5 gm is removed and changed to 0.57 gm, and moved by 30 degrees, that would be 202.5 - 30 = 172.5 degrees. But the holes are at 180 and 157.5 degrees. Why not split the weight between the two available holes? Good idea.
- The hole split technique is shown in Figure 24, right side. Make a parallelogram with the 0.57 at 172.5 degrees, and the other

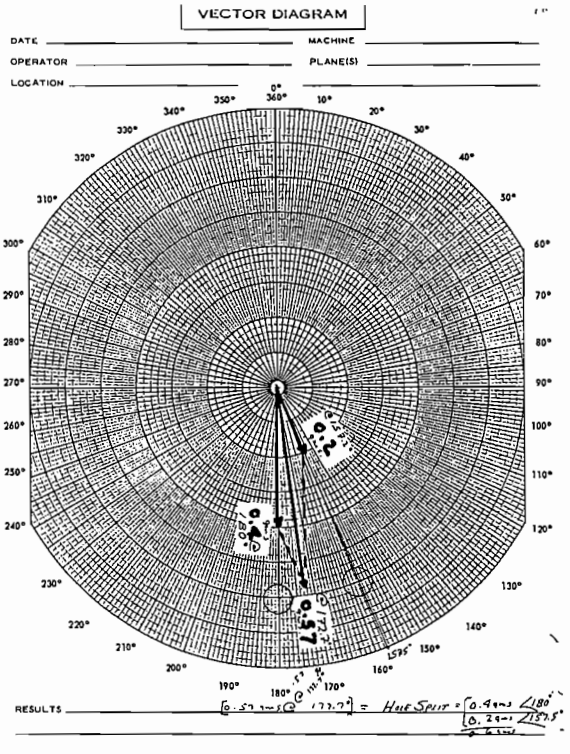
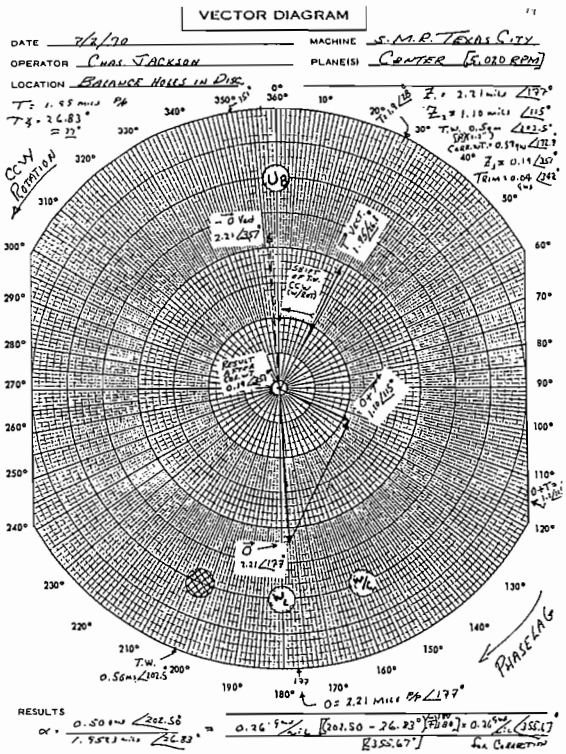

Figure 24. Vector Diagram Plotting of Balance Vectors. Hole splitting the solution weight.

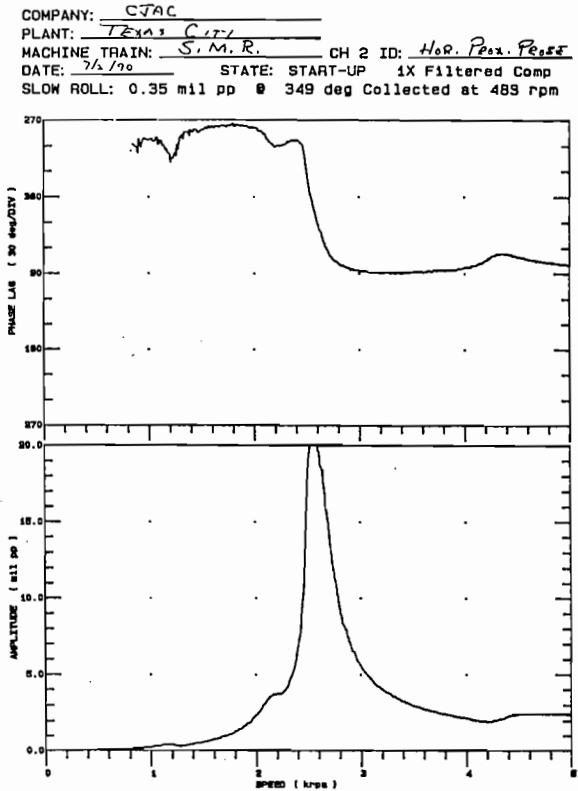
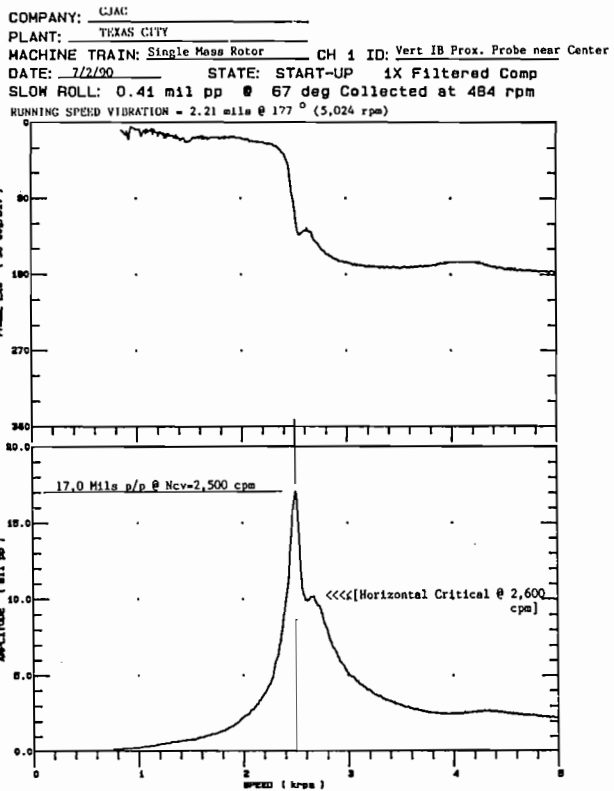

Figure 25. Bodé Plots of Vertical/Horizontal Sensors to Full Speed (5,024 rpm).

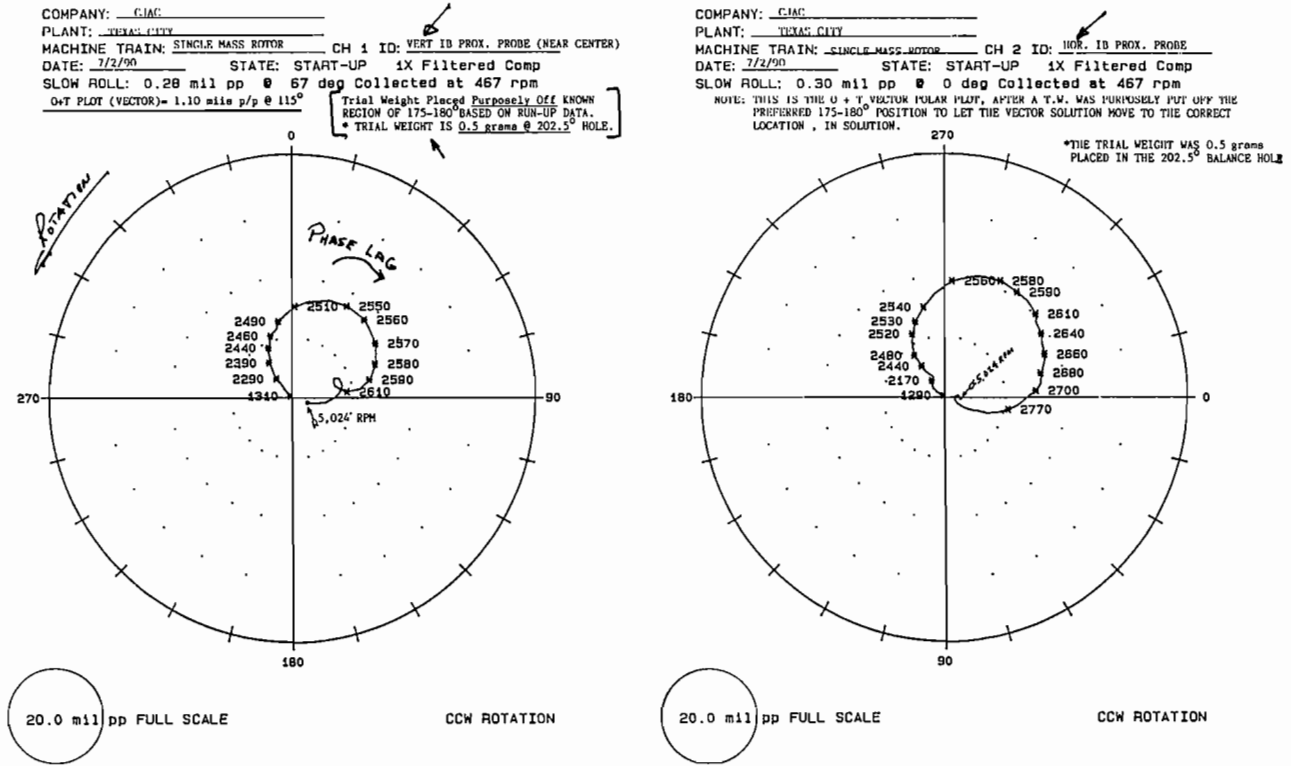

Figure 26. Polar Plots of Vertical/Horizontal Sensors with 0.5 gm at 202.5 degrees (0 + T Vector).

sides parallel to 180 and 157.5 degrees. This says to put 0.4 gm in the 180 degree hole (#9), and 0.2 gm in the 157.5 degree hole (#8). The additive effect of these two weights equals 0.57 gm at 172.5 degrees.

Note: The calculator "SGLBAL" program solution is on the data sheet, Figure 23, with the print out from an HP-41 calculator. The more exact values of correction weight, correction angle, T vector amount, T vector angle, and sensitivity (gm/mil) are printed and recorded.

DETERMINE THE INFLUENCE COEFFICIENT FOR BALANCE CORRECTION

If one will divide the trial weight vector (amount and angle) by the T vector vibration and angle, they would determine the unbalance response vector. If 180 degrees could be added to that, the correction vector could be determined for a future correction.

So, (0.5 gm at 202.5 degrees)/(1.95 mils at 26.83 degrees) = 0.26 gm per mil at 175.67 degrees (202.5-26.83), adding 180 degrees equals 355.67 (record on the data sheet, Figure 23).

CROSS CHECK OF THE INFLUENCE COEFFICIENT ON THIS RUN

- Record the original vibration data, 0 vector = 2.21 mils at 177 degrees.
- Apply (multiply by) the influence coefficient 0.26 gm/mil at 355.67.
- Correction weight amount = 2.21 mils × 0.26 gm/mil = 0.57 gm.
- Correction angle = 177 degrees × I.C. degrees 355.67 = 177 + 355.67 = 172.67.
- Apply 0.57 gm at 172.67 degrees. Checks.

FINAL PLOT AFTER CORRECTION WEIGHT PLACED

The data on Figure 27 are amplified by 4:1 on scale, e.g., full scale is now 5 mils p/p rather than 20 mils p/p. This run shows a vibration of 0.19 mils p/p at 351 degrees. You will also note that the plot switched sides on the polar plot, i.e., the loop is out of phase about 180 degrees. This means the weight was only slightly heavier (actually only 0.04 gm). This can be determined by looking at the "trim" solution, which assumes the correction weight is kept in place, and an additional weight correction is determined. This reinforces another one of those basic rules: if the vibration reduces and the phase angle "flips" 180 degrees, then the correction location is correct but the trial weight is slightly too large.

A Bodé plot of the final balance is presented in Figure 28. The horizontal plot was used to estimate how much damping is in this rotor system by measuring the amplification factor while going through the resonance. Only 3.9 percent of critical damping exists in these bearings, and that is not very good. It would take 6.25 percent damping to get an amplification factor of eight; the response at the critical would be eight times the response well after the critical. It would take 10 percent of critical damping to get an amplification factor of five.

A sweep at running speed, taken before and after the balance, is shown in Figure 29. It is important that other factors such as misalignment, looseness, oil whirl, etc., are removed from a system, and only imbalance (1× synchronous, running speed) is corrected.

A polar plot of the uncompensated for slow roll, i.e., run up of the balanced rotor, is shown in Figure 30. Note that it does not originate at the origin. The polar plot is an excellent presentation to show things like run out, bowed rotors, etc., and the speed at which those conditions are "balanced out," i.e., the point at which the plot goes through zero.

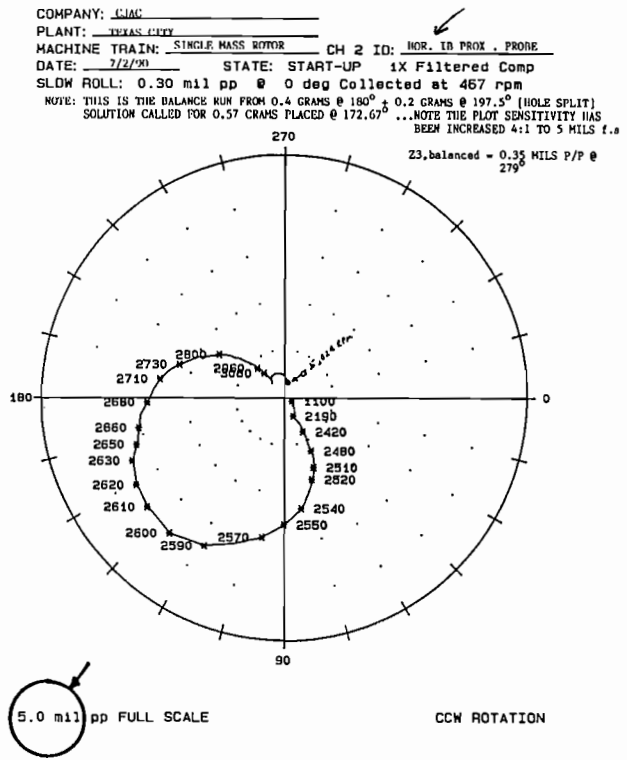
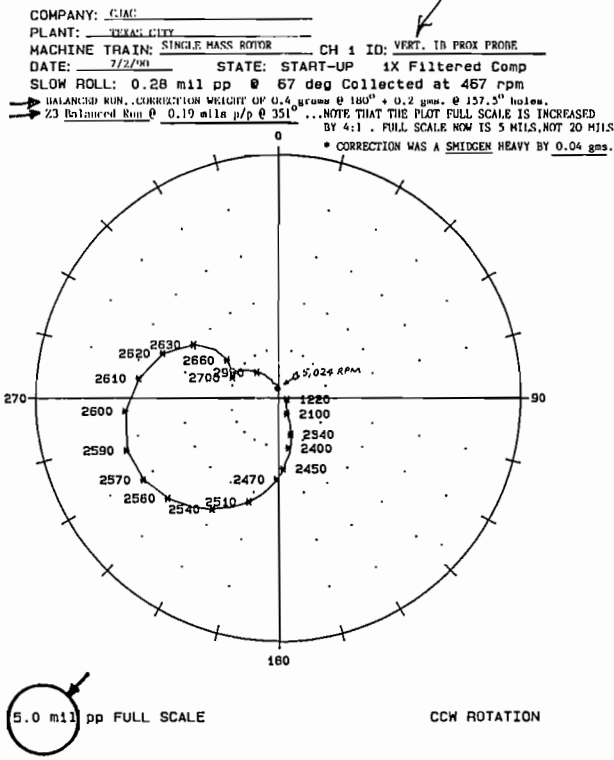

Figure 27. Polar Plots of Vertical/Horizontal Sensors with Correction Weight in Place. 5 mils f. s.

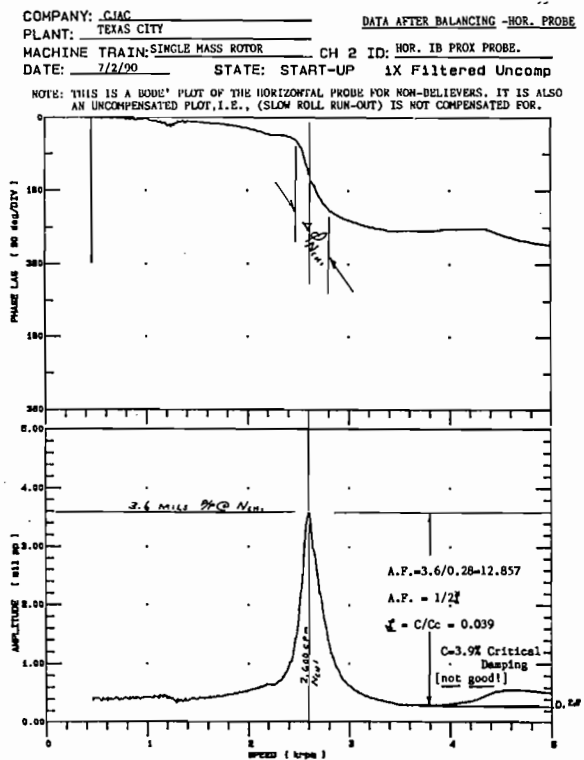
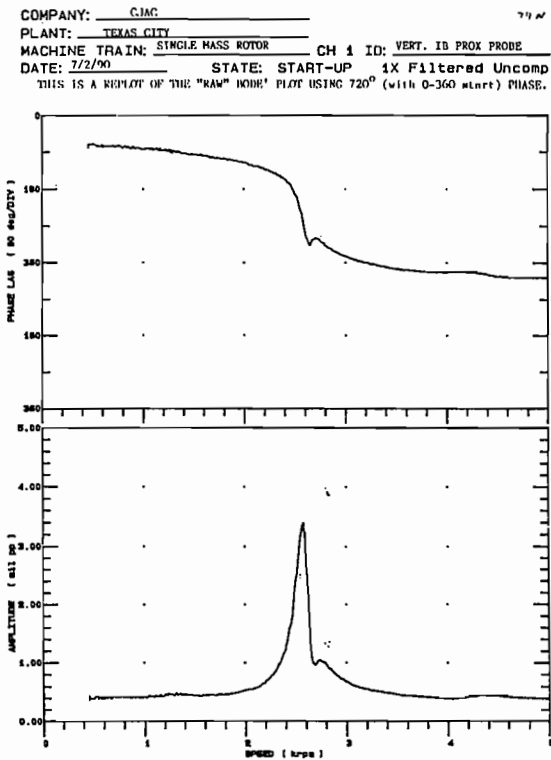

Figure 28. Uncompensated (for Run Out) Plots of Vertical/Horizontal Sensors after Balance.

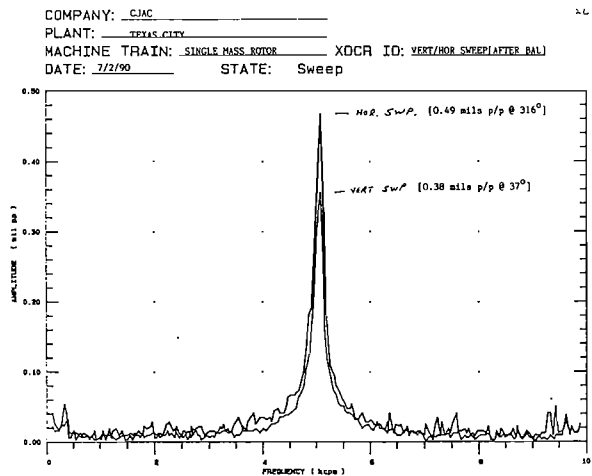
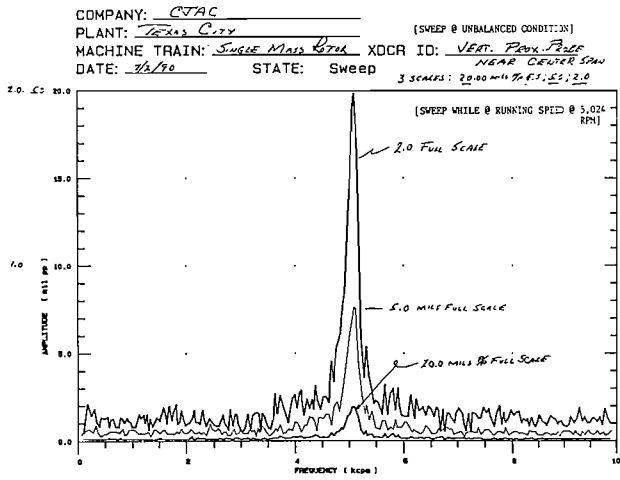

Figure 29. Sweep Plot of the Sensors Balanced and Unbalanced.

An update is furnished in Figure 31 of the same program written for the HP-67/97, when the book, *The Practical Vibration Primer*, was written 11 years ago. It has been upgraded for alpha characters to simplify its use. It will work with or without a calculator. I remain in a "hold harmless" position to anyone using the program incorrectly and wrecking a unit; i.e., I'm taking a disclaimer. It has worked fine for me. I do believe in cross plotting the vectors in every case. I also think it is good to lay out the balance plane with the sensors, keyphasors, balance holes, etc., on the same paper (as viewed) to have better control of logic.

OTHER SINGLE PLANE TECHNIQUES, EXAMPLES, AND COMMENTS

Case histories of a drive turbine are shown in Figures 32 through 35, primarily to illustrate technique. This turbine operates above two resonances—cylindrical and pivotal (conical)—as can be seen by the first, second, and third modes. The third shows the typical overhung coupling effects to most rotors. The fourth animated display is not a mode, but the rotor deflection diagram at operating speed, which shows a "node" very near the governor end balance plane. This rotor had two balances in 13 years, and little effect could be derived from weights placed in the governor end. (Explanation above.) Furthermore, the cross effects were high with the governor (steam inlet) end always being corrected by weights placed in the exhaust end.

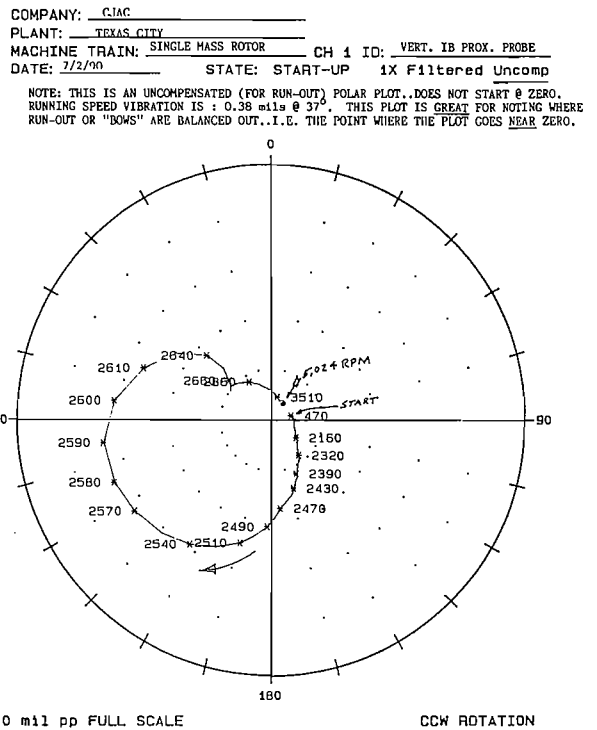

Figure 30. Uncompensated Polar Plot of Balanced Vertical In-board Sensor.

PRP --	50*LBL 02	102*LBL 01	146*LBL "TRIM"	190*LBL A
	51 RCL 06	103 360	147 "ANG?"	191 *CW AMT
	52 RCL 02	104 -	148 PROMPT	192 AVIEW
	53 -	105 RTN	149 ENTERT	193 PSE
01*LBL *SGLBAL	54 STO 22	106*LBL R	150 "AMT?"	194 RCL 06
02 "R.O.ANG?"	55 RCL 07	107 *CW AMT	151 PROMPT	195 VIEW X
03 PROMPT	56 RCL 03	108 AVIEW	152 P-R	196 RTN
04 ENTERT	57 -	109 PSE	153 RCL 00	
05 "R.O.AMT.?"	58 STO 23	110 RCL 20	154 -	197*LBL B
06 PROMPT	59 ENTERT	111 VIEW X	155 STO 06	198 *CW AMT
07 P-R	60 RCL 22	112 RTN	156 X(Y)	199 AVIEW
08 STO 00	61 R-P	113*LBL B	157 RCL 01	200 PSE
09 X(Y)	62 STO 22	114 "CW ANG"	158 -	201 RCL 07
10 STO 01	63 X(Y)	115 AVIEW	159 STO 07	202 VIEW X
11 "Z1 ANG?"	64 STO 23	116 PSE	160 RCL 20	203 RTN
12 PROMPT	65 RCL 22	117 RCL 21	161 STO 09	
13 ENTERT	66 RCL 09	118 VIEW X	162 RCL 21	204*LBL C
14 "Z1 AMT?"	67 /	119 RTN	163 STO 08	205 *T AMT
15 PROMPT	68 STO 25	120*LBL C	164 XEO 02	206 AVIEW
16 P-R	69 1/X	121 *T AMT	165 RCL 21	207 PSE
17 STO 02	70 RCL 05	122 AVIEW	166 ENTERT	208 RCL 20
18 X(Y)	71 *	123 PSE	167 RCL 20	209 VIEW X
19 STO 03	72 STO 20	124 RCL 22	168 P-R	210 RTN
20 RCL 01	73 RCL 05	125 VIEW X	169 STO 02	
21 ST- 03	74 /	126 RTN	170 X(Y)	211*LBL D
22 RCL 00	75 STO 24	127*LBL D	171 STO 03	212 *T AMT
23 ST- 02	76 RCL 25	128 "T ANG"	172 RCL 00	213 AVIEW
24 RCL 03	77 STO 10	129 AVIEW	173 ENTERT	214 PSE
25 ENTERT	78 RCL 23	130 PSE	174 RCL 09	215 RCL 21
26 RCL 02	79 RCL 00	131 RCL 23	175 P-R	216 VIEW X
27 P-R	80 -	132 VIEW X	176 ST- 02	217 RTN
28 STO 05	81 STO 20	133 RTN	177 X(Y)	218 END
29 X(Y)	82 RCL 04		178 ST- 03	
30 STO 04	83 RCL 25		179 RCL 03	
31 "Z2 ANG.?"	84 -		180 ENTERT	
32 PROMPT	85 STO 21		181 RCL 02	
33 ENTERT	86 100		182 R-P	
34 "Z2 AMT.?"	87 +		183 STO 06	
35 PROMPT	88 STO 21		184 X(Y)	
36 P-R	89 X(0)		185 STO 07	
37 STO 06	90 XEO 00		186 X(0)	
38 X(Y)	91 ENTERT		187 XEO 00	
39 STO 07	92 360		188 STO 07	
40 RCL 00	93 X(Y)		189 RTN	
41 ST- 06	94 X(Y)?			
42 RCL 01	95 XEO 01			
43 ST- 07	96 STO 21			
44 "T1 AMT.?"	97 RTN			
45 PROMPT				
46 STO 00	98*LBL 00			
47 "T1 AMT.?"	99 360			
48 PROMPT	100 +			
49 STO 09	101 RTN			

Figure 31. SGLBAL Program for HP 41 Calculator. Vibration primer with update.

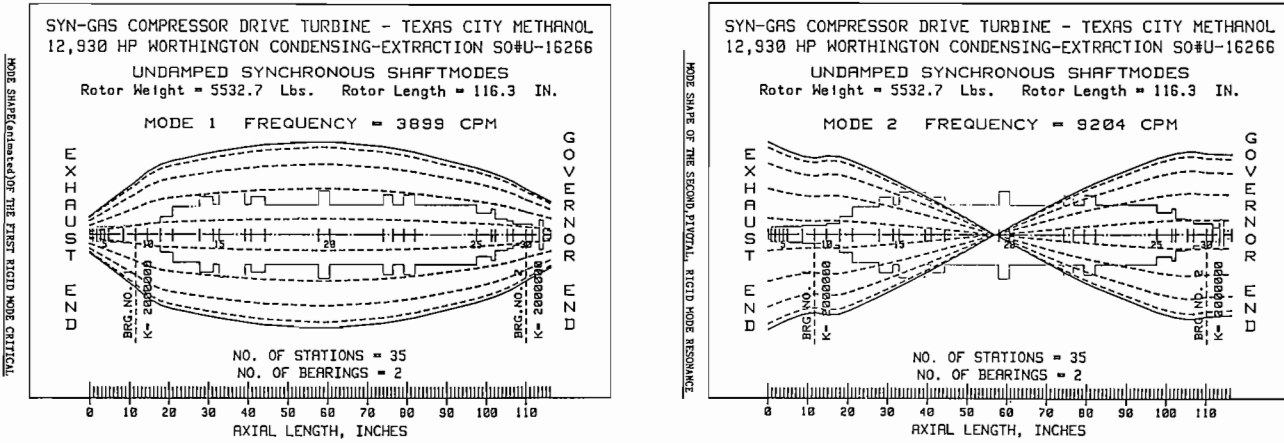

Figure 32. First and Second Mode Shapes, Animated, for Steam Turbine Balance Data. C. Jackson.

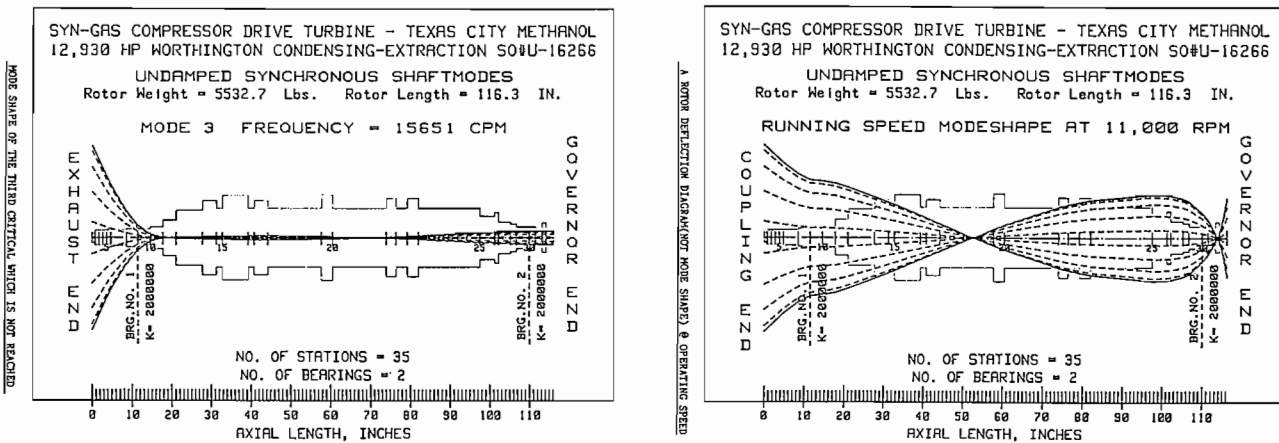

Figure 33. Third Mode Plus Running Speed Deflection Shape. Jackson and Leader.

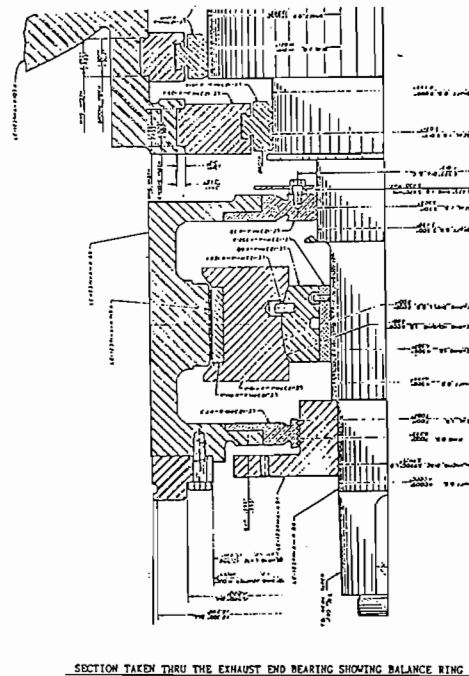
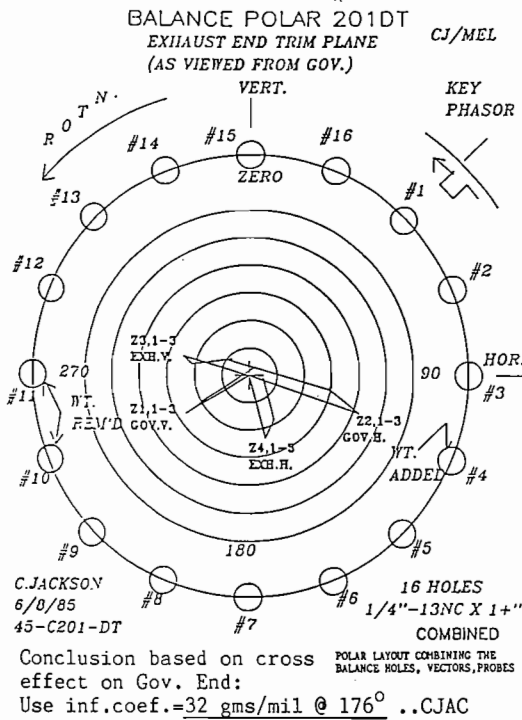
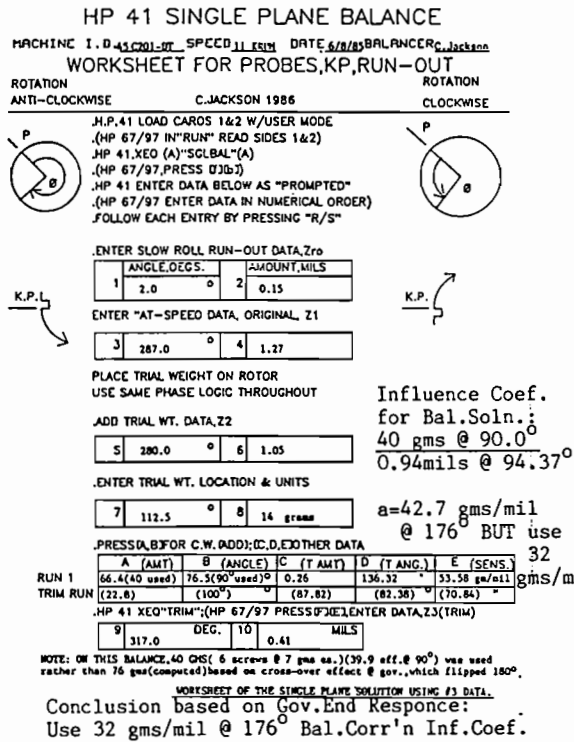

Figure 34. Balance Plane with Vector Plots and Instrument Locations, Plus Balance Plane.



SINGLE PLANE SOLUTION WITH RUNS

PROBE ID	ORIGINAL		TRIAL RUN		FINAL W/C.W.T.	
	AMP	PHA.	AMP	PHA.	AMP	PHA.
GOV.V.Z1	1.32	239	0.85	243	0.21	37
GOV.H.Z2	2.15	109	1.45	101	0.53	303
EXH.V.Z3 *	1.27	287	1.05	230	0.41	317
EXH.H.Z4	1.21	165	0.90	151	0.25	100

XEO "SGLBAL"
 R.O. ANG.? 2.00
 R.O. AMT.? 0.15
 Z1 ANG? 287
 Z1 AMT.? 1.27
 Z2 ANG? 280
 Z2 AMT? 1.05
 T.W. ANG? 112.50
 T.W. AMT.? 14GMS

CALCULATION--STATIC/COUPLE
 SAME
 SAME
 Z1 ANG? 252 DEG
 Z1 AMT? 1.22 MILS
 Z2 ANG? 253 DEG.
 Z2 AMT? 0.92 MILS
 SAME
 SAME

C.W. AMT.= 66.42 GMS. C.W. AMT = 57.52 GMS
 C.W. ANG. = 76.47 DEG. C.W. ANG. = 101.63
 T VEC. AMT. = 0.26
 T VEC. ANG. = 136.32 DEG.
 SENSITIVITY U/M = 53.58 GMS/MIL U/M = 46.58 GMS/MIL

CORRECTION USED= 40 GMS.

TRIM DATA:
 ANGLE = 317
 AMOUNT = 0.41
 C.W. AMT. = 22.8
 C.W. ANG. = 99.86 DEG.

NOTE: TRIM NOT USED*
 *GOV.H. CROSSED ZERO

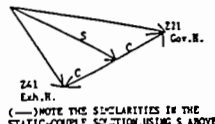

PRINT OUT OF SINGLE PLANE SOLUTIONS VECTORS OF 3 RUNS

Figure 35. Data Sheets on Turbine Balance In Situ Using Single Plane Solution with Care.

This started out to be a two plane problem, but on observation of the first trial weight placed by previously determined influence coefficients, the turbine could be corrected sufficiently using single plane logic coupled with observance of the front end response, e.g., not overcorrecting and using 75 percent of the solution weight amounts.

Balancing data are depicted in Figures 36 through 38 for an overhung pipeline compressor. The mode shapes are very similar

BALANCE POLAR PLOT FOR 202 24"COMP

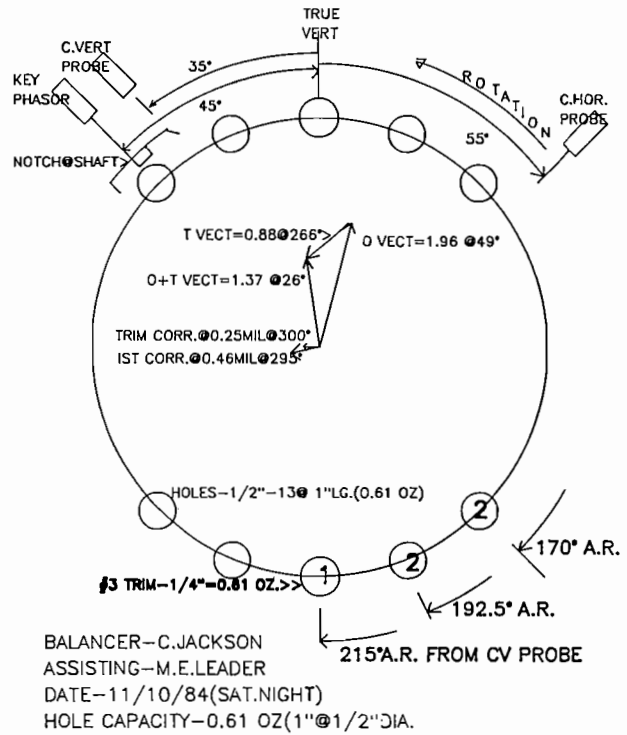

Figure 36. Balance Plane and Vector Layout for Balance In Situ of Overhung Compressor.

to that of an overhung process pump. The first and second modes are both pivotal. This unit was balanced by adding a balance ring and using single plane balancing, being sure that the measurement point and the weight add points were both on the same side of the rotor's nodal point.

A large process pump, shown in Figure 39, had a coupling heavier than the impeller, and as a result operated on the first resonance, failing bearings in 21 installations in less than two weeks. It emphasizes the coupling effects on the rotor. The right side shows a before and after run up due to a coupling with 2.0 to 3.0 mils of eccentricity, but with good balance being installed on a turbine, with good balance. The coupling was reversed by 180 degrees to get the smooth run up canceling out a field balance program.

The concerns for coupling balance, proper coupling assembly against eccentricities, proper use of keys, and the effects on the second modes of any rotor due to excessive weight moments (both weight and overhang) of couplings are emphasized in Figure 40.

A technique of balancing by matching the residual unbalance of a coupling to the residual unbalance of a rotor is shown in Figure 41. It was first presented to the Vibration Institute by Tony Winkler (1983), and improved on by C. Jackson (1984). It does require that the element be capable of circumferential positioning around a rotor shaft. This could be by hydraulic dilation, splines, bolted assembly, etc., and is not limited to couplings. It would, and has, worked with any element attached to a rotor. It is limited in balance value to the residuals in each component; i.e., it is a "fixed weight" balance and looks very similar to static-couple plotting. The rotor is run up for an unsuccessful balance. The coupling is reversed by exactly 180 degrees. The second vector is plotted as shown in Figure 41. The coupling is rotated from the second position by the amount required to pass the couple value through zero (103 degrees with rotation in the example shown). The

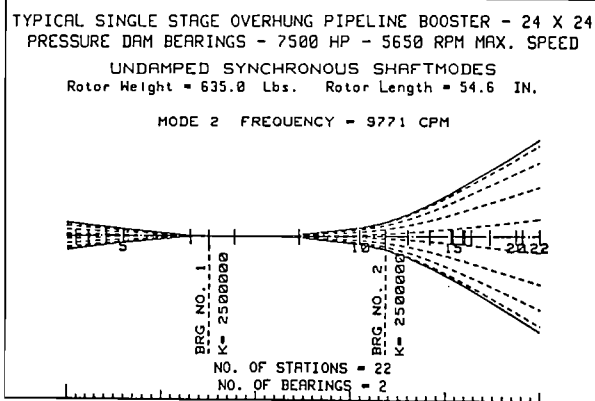
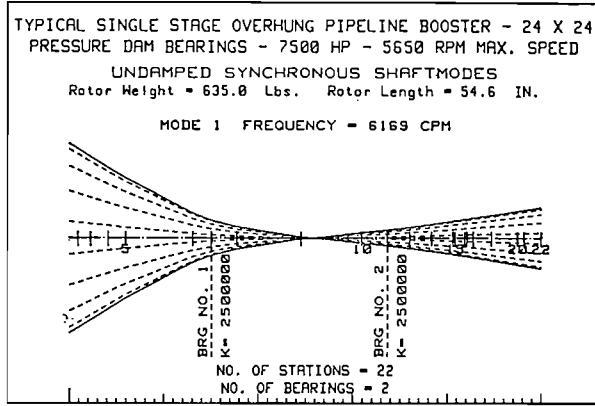
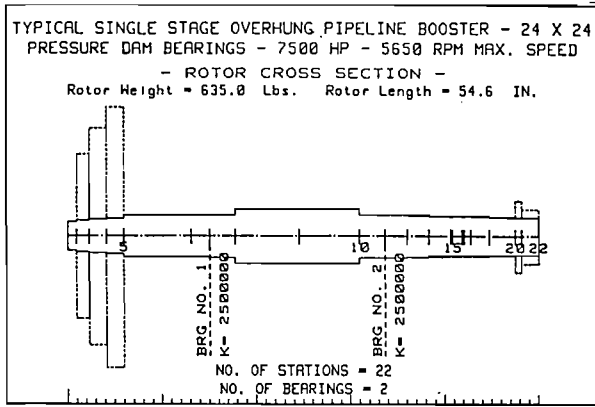

Mode diagrams and rotor model; first and second modes or pivotal

Figure 37. First and Second Mode Shapes of Overhung Compressor. Similar to overhung pump.

predicted result will be the plotted differences between the new vector and zero (0.2 mils in the demonstration shown performed on a actual rotor). Several multistage injection pumps were shipped successfully using this technique.

The steps in balancing just performed using complex notation are shown in Figure 42. The lower right data was taken from a motor, where two proximity sensors were placed in the cap looking at the shaft, and two velocity sensors were placed at the same locations. The problem was not balance. The problem was that the shaft "strikes" the bearing sleeve when the shaft moves "right." The displacement signal is "truncated" going right (top of sine wave). The velocity sensor is impacted (rings down in decay each

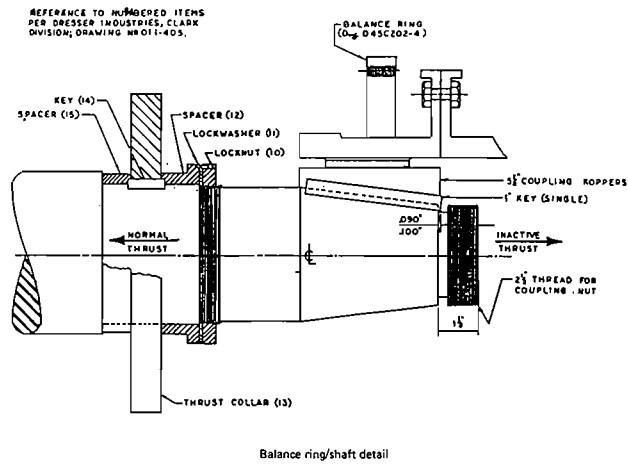
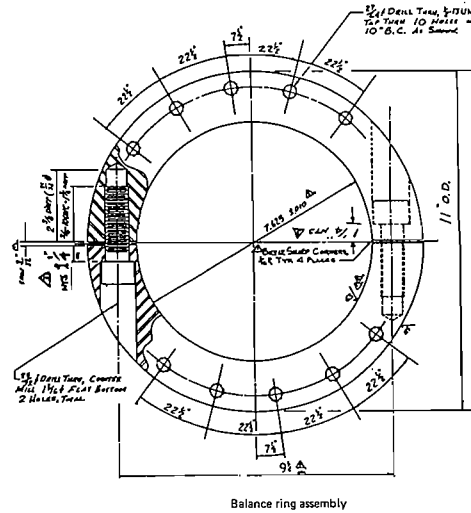
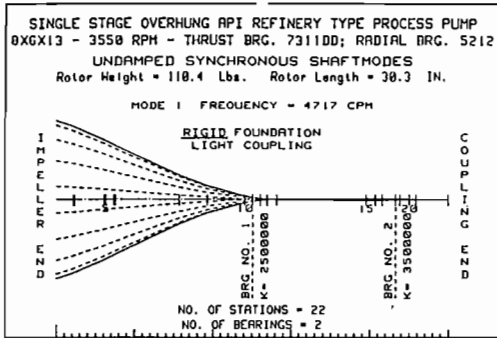

Figure 38. Balance Ring for Overhung Compressor. Similar built, with care, for pumps.

revolution). The problem was that the motor was horizontally out of alignment—not balance. It does show in the two lower time traces that the "high spot" and the "heavy spot" are pretty well out of phase by 180 degrees. This 6,000 hp motor was above its first resonance. Hark!

A four run method of balancing without using phase is also shown in Figure 42. It is also called the three run method, if the machine is running when one gets to the balancing site. In this procedure, the original run is plotted as a circle with a scale radius based on the original vibration value, 0 amount. Then a trial weight is placed on the unit to be balanced, e.g., one blade of a six bladed fan. That vibration is plotted to the same "scale," but drawn from the base circle just plotted. That same weight (or same weight times inches of placement) is rotated, say to the #3 blade (120 degrees), that vibration is plotted off the same base circle, but around the circle 120 degrees from the first plot. These two circles should intersect at two points. Now, to determine which intersection is correct, the weight must be moved one more time and a third run made. This circle must be drawn another 120 degrees around (blade #5). It is not necessary to move 120 degrees, but whatever position the weight is moved, the same degrees must be moved on the base circle. The intersection of all three circles defines the



Mode Shape of 8 x 6 x 13 API Pump (Rigid Foundation/Light Coupling).

SYNCHRONOUS CRITICAL SPEED ANALYSIS

NO.	CRITICAL SPEED	MODE	ITRIDE	KTRIDE	USHAFT	UBEARING
UNITS	RPM (HZ)	LB	LB/IN ²	LB/IN	DIAM.	STRAIN ENERGY
1	4717 (79)	37.0	1.84E-01	3.68E-04	91	9
2	53482 (891)	6.8	3.59E-01	4.98E-03	36	64
3	67522 (1125)	9.8	6.42E-01	1.27E-06	42	38

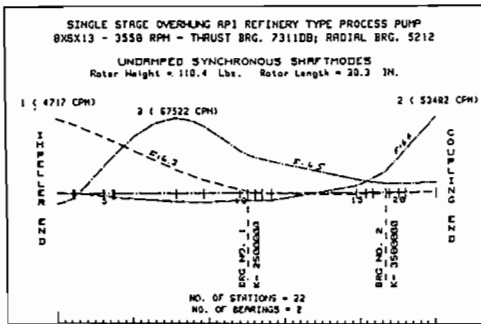

Critical Speed Modes and Strain Energy in Shaft and Bearings (Figure 19).

NO.	CRITICAL SPEED	MODE	ITRIDE	KTRIDE	USHAFT	UBEARING
UNITS	RPM (HZ)	LB	LB/IN ²	LB/IN	DIAM.	STRAIN ENERGY
1	3580 (60)	66.6	1.79E-01	2.43E-04	61	39
2	9329 (156)	39.6	2.47E-01	1.48E-03	25	65
3	35345 (589)	22.0	7.01E-01	7.02E-03	25	75

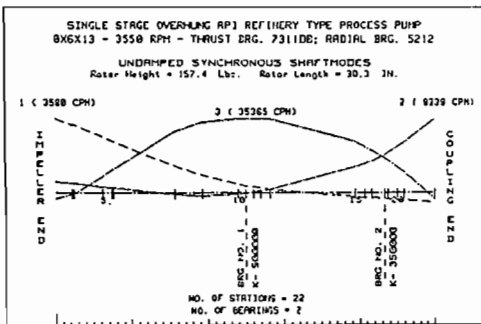

Criticals and Strain Energy with Heavy Coupling.

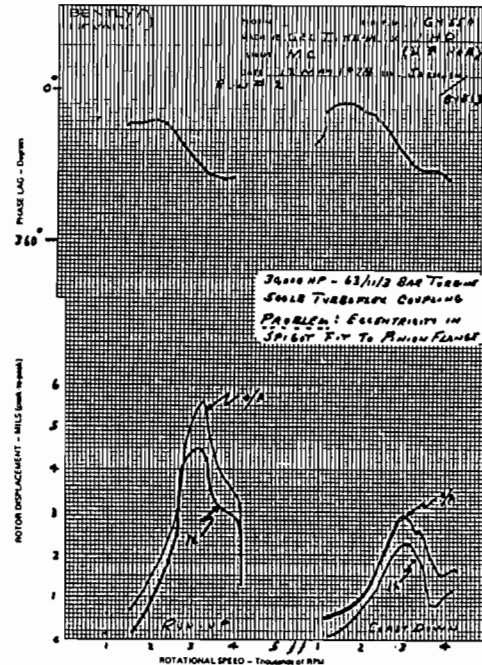

Response of 30,000 HP Drive Turbine to Coupling Eccentricity.

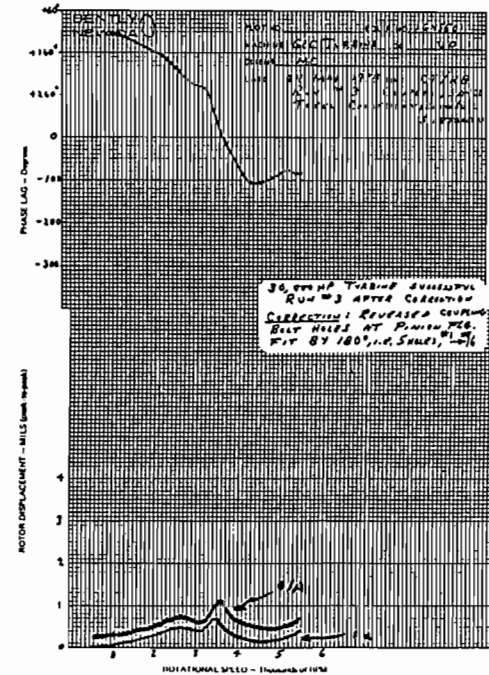

Vibration Response After Reversing 180 Degrees at Pinion Bolts.

Figure 39. Mode Shapes for API 8x6x13 Pump with Light/Heavy Coupling. Vibration response of turbine with balanced coupling mounted with/without eccentricity.

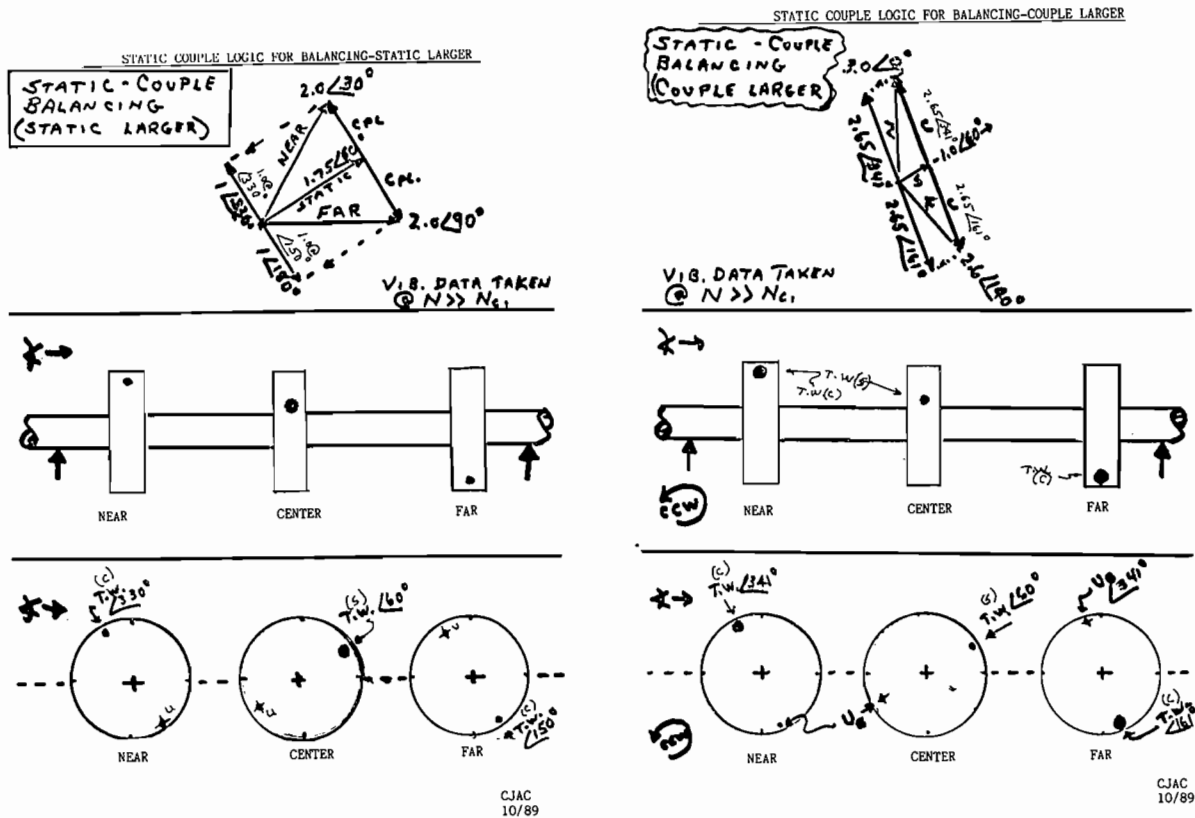

Figure 43. Single Plane Approach to Static-Couple Balancing Using Same Phase Location Logic for the Weight Placements.

BALANCING SPECIFICATIONS

A balancing specification that Mr. Issac Wilburn Hickham and I wrote in a restaurant one midnight, about 20 years ago, is shown in Figures 44 through 46. It is a good balancing specification. It is generally understood by most inspectors with high school or greater education. It only requires one to know the machine speed and journal weights. The journal weights can generally be measured in the shop. It can determine a value based on most any kind of shop balancer. It resolves the residual imbalance to a value that creates 1/10 the journal weight (lb) at rotating (or balance) speed. In simple terms, if a rotor weighed 2000 lb, i.e., equally supported with 1000 lb on each journal (journal weight = 1000 lb), and operated at 6,000 rpm, then the balance tolerance in that plane would be 44.44 gm-in. The force from that residual imbalance at 6,000 rpm would be 100 lb, i.e., 1/10 g, and the vibration from that residual unbalance would be 44.44 gm/1000 lb (454 gm/lb) × 2 = 0.2 mils p/p. The 44 - 45 gm-in, incidently, is what I would use for the trial weight, not given any other values to use.

This 1/10 g term was used by API for years via a formula that looked something like: balance tolerance, oz-in. = 56,347 (journal weight, lb)/(rpm)². In our case, (56,347 × 1000 lb)/(6,000)² = 1.56 oz-in (28.35 gm/oz) = 44.4 gm-in.

The two charts on Figure 46, a new chart and an old chart, from ISO. ISO grades are in mm/sec. If mm/sec are divided by the speed in radians/sec, the eccentricity will be in millimeters, and on the ordinate mm = kg-mm/kg (or) mm × 25.4 mm/in = in of eccentricity or lb-in/lb. Most full speed vacuum balancing facilities use a value of 1.0 mm/sec ISO. Fan builders use 2.5 mm/sec.

API has recently adopted a tighter lower speed balance tolerance. That was the old Navy Standard of oz-in = 4W/N, where W = journal weight in lb, N = speed in rpm. For our example above, this

would give the balance tolerance as 4 (1000 lb)/6000 rpm = 0.66 oz-in or 19 gm-in.

Two charts are shown in Figure 47. One is a comparison of the balance tolerances just mentioned. The other is a residual unbalance plot for 12 points (by Chevron) per the latest draft of API, which can require that after balance, a 12 run plot is to be made and the values plotted, as shown, to determine the residual unbalance value and the location on the rotor. This procedure has been in the Schenck Balancing Procedures for years for calibration of "proving rotors" to check balancing machines.

Finally, Figure 48 is one attempt to help in deciding whether a rotor might need to be balanced in a full speed vacuum balancer.

SUMMARY

Why so much on single plane balancing? There is more single plane balancing done in the field than multiplane balancing, in my opinion. The logic of balancing can best be conceived in single plane balancing. Those principles can be used for selection of weights and location for multiplane balancing. It is important to have some idea of the correct balancing quadrant. It should not be arbitrary on the placement of a balancing (calibration) weight. The math may work out correctly, but there is one caveat; if one is just a little bit clumsy, the second data point *may not be determined*. The credibility of the balancer is more enhanced if the trial (calibration) weight *reduces the vibration*. Balancing without run up data seems poor with today's instrument abilities.

The proximity sensor was used in this balancing example. It does not have a mechanical or electrical lag. A velocity sensor may well have both. The utilities often use dual sensors where the shaft relative data is taken on one sensor and added to the bearing cap absolute vibration to give those two values, plus the sum, which is

BALANCING LIMITS - ROTATING EQUIPMENT

TEXAS CITY, TEXAS

SCOPE: This procedure shall define tolerances for minimum acceptance of all rotating elements requiring balancing. Tighter specs can be specified by the engineer or supervisor requesting balance work.

INTENT: To provide balance tolerances based on journal force, unbalance units, or displacement (p/p) which should accommodate any machine shop balancer or field unit.

LIMITS: The assemblies shall be sequentially balanced with no greater than two elements assembled for any individual balance operation. The final balance shall not allow a residual unbalance force exceeding 10% of the rotor's static journal weight. This balance tolerance shall be determined at maximum continuous speed, i.e., 105% of rated speed per API definition.

EXCEPTION: For extremely light rotors operating greater than 20,000 RPM, a residual unbalance limit of 0.1 oz. -inches or 25 micro(p) inch peak-to-peak(p/p), whichever is less, shall be obtained.

Balance of heavy low speed blowers can meet the G-2.5 quality as referred to in the Standards by the Society of German Engineers (attached).

EXAMPLE:

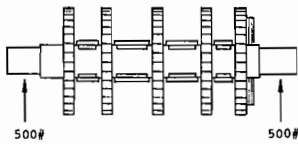

- Rotor weighs 1000 lbs.
- Rotor is asymmetrically stacked, (normally both journal weights are determined separately)
- Static journal weights=500 lbs.
- Rated Speed is 9000 RPM
- Max. Cont. Speed = 9450 RPM

APPLYING THE LIMIT:
 Force(Residual) = (Mass)(Acceleration) = $1.77 \frac{(RPM)^2}{(1000)} (oz. -in.) = 50 \text{ lbs.}$

or..... = $\frac{(RPM)^2 (gm. -in.)}{(1000) (16)} = 10\% \text{ of } 500 \text{ lbs.}$

(1)

then the balance tolerance

oz.-inches = $\frac{(\text{journal wt. lbs.})(.10)}{(1.77) \frac{(RPM)^2}{(1000)}}$ or oz.-in. = $\frac{56,347(\text{journal static})}{(RPM)^2}$

[Above Monsanto]----- [Above API 617 2.18.3,10/1973]-----

Applying the example information:

oz.-in. = $\frac{(50 \text{ lbs.})}{1.77(9,45)^2} = 0.316$ or oz.-in. = $\frac{56,347(500 \text{ lbs.})}{(9450)^2} = 0.316$

gm. -in. = (0.316 oz.-in.) (28.35 gm.-in./oz.-in.) = 8.958

Mass Center Displacement(MCD), in. = $\frac{\text{Balance Tolerance, oz.-in.}}{\text{Wt. @ journal, oz.}}$

MCD = $\frac{316 (10^{-3})}{(500)(16)} = \frac{316 (10^{-3})}{8 (10^3)} = 39.5 \text{ micro-inches}(\mu\text{'})$

Displacement(p/p) = $2 \times \text{MCD} = 2 \times 39.5 = 79 \mu\text{' inches}$
 or 0.079 mils(p/p)

FINAL RESULTS: Force = 50 lbs.
 Unbalance Units = 0.316 oz.-inches or 8.958 gm.-inches
 Displacement = 79 μ inches (p/p)

PROCEDURE: (1) The rotor shall be balanced to the best balance, i.e., zero or within the balance tolerance with no phase angle or "shaky" phase angles indicated on either end.

Note: Runout shall be checked after each pair of elements and sleeves are installed to confirm no "cocking". 5-6 mil shim pairs should be used to prevent sleeve or impeller binding, "slipping out" after shrink grab.

(2) A weight, W, shall be placed on one end and the phase angle noted.
 W=Balance Tolerance/radius of placement, inches
 W(example)= $0.316/10''$ radius on wheel 1 = $0.0316 \text{ oz.} = .896 \text{ gms}$

(3) The same weight shall be moved 180 degrees from this placement(2), and the new phase angle noted. This change of angle should be at least 170 degrees (min.).

(2)

Figure 44. Balancing Specification for Plant Use. (Jackson.)

(4) Further test weights, W/2, 2W, 4W shall be prepared and placed alternately at that radius, spinning the rotating element and recording all four readings on the balancing machines readout.

(5) A smooth curve shall be plotted of the test weights versus the balancing machine readouts. This curve shall be continued smoothly to a theoretical zero readout.

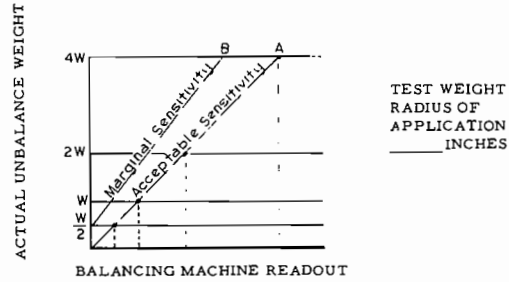

BALANCING MACHINE RESPONSE CHECK

(6) This process shall be repeated for the other end of the rotating element, and a similar curve shall be plotted.

(7) If either of the two extrapolated curves intersects the ordinate at W/2 or higher, it shall be concluded that the sensitivity of the balancing machine system in use is either marginal or unacceptable, and the rotating element shall be rebalanced using a more sensitive machine.

(8) The weight, W, shall be reduced in steps, W/4, W/8... until the phase will not shift by 170 degrees. This final weight and radius shall be recorded in the permanent record of the residual unbalance.

FINAL REPORT:

The residual unbalance shall be recorded along with the correction plane, the phase angle, and the reference* coordinate system used. Also included shall be the original unbalance; and the weight, radius, and angle required to correct. The balance machine response check must be a part of the final report.

* Based on final balancing, the residual unbalance angle is to be referenced to a physical identification on the rotor, e.g., 30° CW from single key facing shaft end or 120°, against rotation, from key phasor groove.

ORIGINALLY PREPARED BY: Charles Jackson, Mechanical Technology, Texas City, Texas, in 1966. (0.08 g).

REVISION I: C. Jackson, 1/27/71, (Adding Procedure).

REVISION II: C. Jackson, 3/15/74, (to agree with API 617 limits) (0.10g).

REVISION III: C. Jackson, 12/15/83, Phase to be rotor physical reference.

Guidelines for Balance Weights (BW) by Modal Distribution

For balancing, after sequential stacking, or trim of rotor assembly from 1) repair in progress or 2) rotor taken from long term storage.

Rotor Operates Below 1st Rigid Resonance

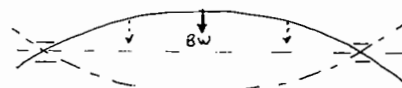

Rotor Operates Between 1st and 2nd Rigid Resonance

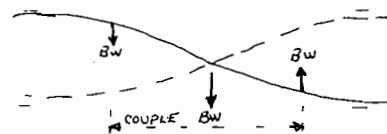

Logic: Center BW corrects 1st mode; does not affect 2nd mode. Couple BW for 2nd mode; does not affect 1st mode. For higher modes or non symmetrical modes; review rotor mode shapes.

Figure 45. Balancing Specification for Plant Use. (Jackson.)

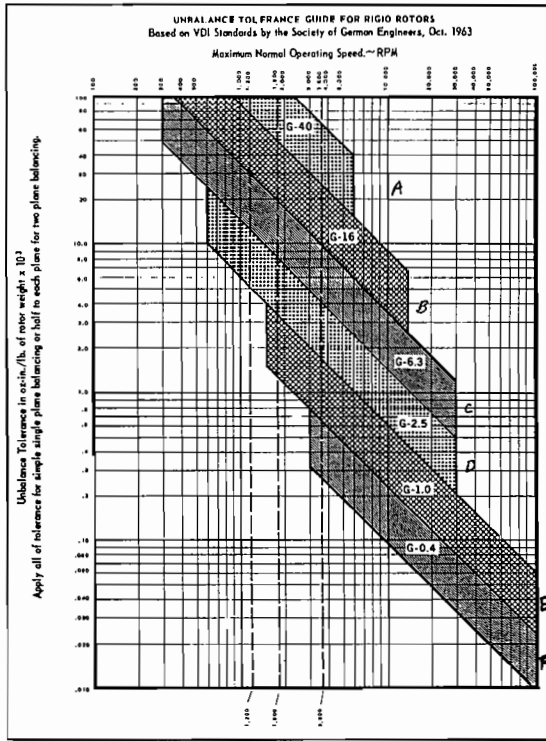

Unbalance Tolerance Guide for Rigid Rotors.

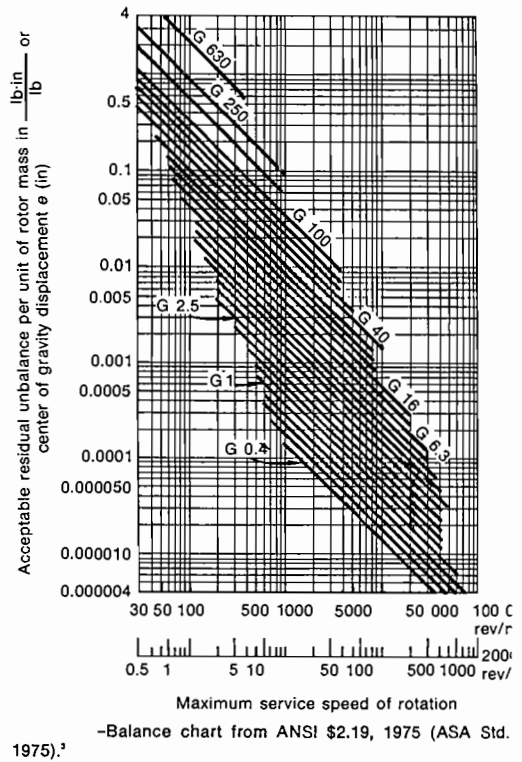

Figure 46. ISO Grade Balancing Charts.

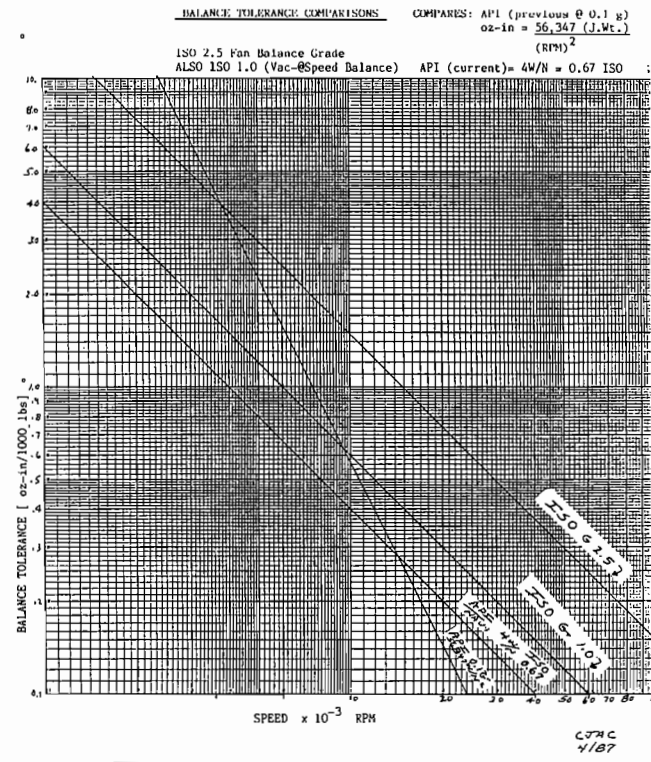
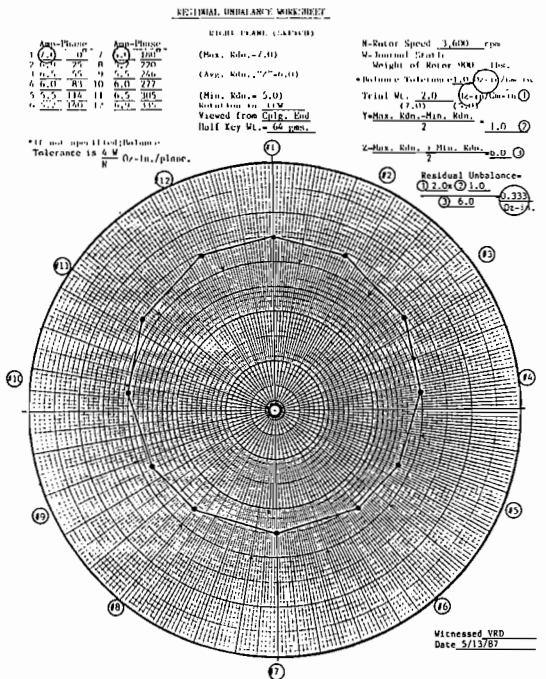

Figure 47. Comparison of Balancing Grades (Jackson/API). Residual Unbalance 12 Point Plot by Chevron (After Dodd/East).

HIGH SPEED BALANCING - SPIN PITWHEN IS HIGH SPEED BALANCE LOW IN NEED?

- (A) A ROTOR WHICH HAS HISTORICALLY HAD ACCEPTABLE LOW SPEED BALANCING,
- (B) A ROTOR THAT OPERATES 1) BELOW THE 1ST RIGID MODE OR 2) IN A NON-BENDING RIGID MODE,
- (C) A ROTOR WHICH IS SEQUENTIALLY STACK BALANCED (1 OR 2 ELEMENTS PER BALANCE STEP (WITH R.O. CHECK),
- (D) A ROTOR WITH HIGH SHAFT STIFFNESS (LOW FLEX.) VERSUS BEARING STIFFNESS,
- (E) A ROTOR OPERATING IN A SPEED RANGE WITH WIDE SEPARATION FROM ROTOR RESONANCES,
- (F) A ROTOR WITH HIGH STABILITY BY ANALYSIS (HIGH LOG. DEC.),

WHEN MIGHT HIGH SPEED BALANCE BE WISE?:

- (A) A ROTOR WITH HIGH OPERATING SPEED (E.G. > 9,000 RPM) WITH POOR HISTORY,

COMPLICATIONS -	NO STACK BALANCING
LONG SPAN -	ROTORS REQUIRING PARTIAL DISASSEMBLY BEFORE INSTALLATION
MANY ELEMENTS - 9,10 ... -	PARTIAL REPAIR OR DES. MODIFICATION
 - (B) OPERATION "NEAR" OR "THRU" OR "ON" ROTOR CRITICAL RESONANCES,
 - (C) ROTORS WITH 1 OR 2 OVERHUNG MASSES (LONG OVERHANGS ARE WORSE),
 - (D) LOW SHAFT VERSUS BEARING STIFFNESS (E.G. $\frac{2KB}{KS} > 8-10$,
- ADDED ADVANTAGE: ° MODAL PLACEMENT OF WEIGHTS (BALANCING IN VACUUM CHAMBER)
- ° MODAL PLACEMENT OF WEIGHTS (FIELD BALANCING IN MACHINE)

C. Jackson 1982

the shaft absolute vibration. Some people use shaft riders where the shaft motion is measured from a sensor that actually floats on the shaft like a bearing pad or shaft stick.

BIBLIOGRAPHY

Jackson, C., *The Practical Vibration Primer*, Houston, Texas: Gulf Publishing Company (1979).

Jackson, C., Notes written for the Vibration Institute for Training. Jackson, C., "Considerations in Hot and Cold Alignment and Couplings," *Proceedings of the 7th International Pump Users Symposium*, Turbomachinery Laboratory, Department of Mechanical Engineering, Texas A&M University, College Station, Texas (1990).

Jackson, C., "Repositioning a Coupling's Residual Unbalance To Correct a Rotor's Unbalance-CPLGBAL," Vibration Institute, Clear Lake Texas, and Annual Rotordynamics and Balancing Course (1984).

Figure 48. High Speed Balance Considerations of Need (Jackson 82).