

DISC PUMP-TYPE PUMP TECHNOLOGY FOR HARD-TO-PUMP APPLICATIONS

by

John Pacello

Vice President of Engineering

Discflo Corporation

El Cajon, California

and

Peter Hanas

Staff Reliability Engineer

El Dorado Refining Company

El Dorado, Kansas



John Pacello is Vice President of Engineering for Discflo Corporation, in El Cajon, California. He has held this position since 1993. Mr. Pacello has more than 30 years' experience in engineering, design, marketing, and management, with extensive involvement in the design and manufacture of disc pump technology.

Mr. Pacello received a degree (Management and Administration, 1983) from the Canadian Institute of Management, and

was granted the designation of Professional Manager in 1986 (MBA equivalent). Mr. Pacello is a Member of N.A.C.E. International.



Peter Hanas is Staff Reliability Engineer at the El Dorado Refining Company, a subsidiary of Frontier Refining and Marketing, Inc., in El Dorado, Kansas. He has 15 years' experience with Texaco, Inc., at four of its petrochemical plants. Mr. Hanas is currently assigned in the Maintenance and Reliability Department where he is responsible for improving the plant's overall mechanical reliability. He is also involved in root cause failure analysis

of rotating equipment and improvement projects.

Mr. Hanas has a B.S. degree (Mechanical Engineering, 1975) from the University of Alabama. He has been an active member of the American Society for Quality (ASQ) for several years and has served as an officer in the local section. He holds five ASQ certifications including Certified Reliability Engineer and Certified Quality Engineer.

ABSTRACT

This paper describes a unique pumping concept based on a noncontact mechanism operating solely using the principles of boundary layer and viscous drag. The first section focuses on the pumping technology itself, describing how the pump mechanism operates, while the second section examines how the pump functions in problem applications, such as handling abrasive, viscous, high solids, air-entrained, and shear sensitive fluids. The next section describes the pump operating and design characteristics, including information on the pump's NPSH

requirement and other standard pump performance data. The final section describes an end-user's experience with the disc pump in an oil refinery application.

The disc pump system operates solely using the principles of boundary layer and viscous drag, two phenomena well-known in fluid engineering. Although superficially the disc pump looks like a centrifugal unit, it has no impeller in the traditional sense, and uses instead a series of parallel, rotating discs, referred to in this paper as the "disc assembly," to generate the energy necessary to move product.

The key difference between the disc assembly and a standard centrifugal pump impeller is that, with the disc assembly, the pumpage does not impinge on the rotating pump mechanism, so that it generates a pulsation-free, laminar flow pattern through the pump. The disc pump can operate effectively in hard-to-pump applications because it lacks an "impingement" device, which results in minimal contact between the pump and pumpage.

INTRODUCTION

Hard-to-pump applications, such as pumping highly abrasive slurries, viscous slurries, slurries with a high solids content, fluids with entrained air, and fluids containing delicate or shear sensitive products, can lead to problems of frequent downtime, high maintenance, and damaged product. In this paper, the authors propose that many of these problems can be alleviated by minimizing the contact between the pump and the product being pumped, and that the "disc pump," which operates using a noncontact mechanism, is well suited to these types of applications.

The disc pump's noncontact pumping ability stems from its unique method of pumping: it operates solely using the principles of boundary layer and viscous drag and does not use an "impingement" device—such as a vane, paddle, screw—to move product. The mechanism itself is a series of parallel discs, herein called the "disc assembly," rotating in a plane perpendicular to the pump inlet. The energy from the rotating discs is transferred via viscous drag—in essence, friction—to the fluid, and the fluid spirals out to the outer edge of the discs and through the discharge.

The section, END-USER'S EXPERIENCE WITH THE DISC PUMP, contains information concerning the El Dorado Refining Company, of which the coauthor is an employee. It is a division of Equilon Enterprises LLC, a joint venture of Texaco Inc. and Shell Oil Company.

DISC PUMP PRINCIPLE

Disc pumps operate on the principles of boundary layer and viscous drag. These principles and their application are relatively new to the world of pumps, but they are well-known in other areas

of fluid engineering, for example, in determining the pressure drop or friction loss through a piping system. The resistance to flow as a liquid moves through a pipe is due to viscous shear forces within the liquid and turbulence along the walls due to roughness.

Fluid can move through a pipe with laminar flow (Figure 1) or turbulent flow (Figure 2). Under laminar (nonturbulent) flow conditions, streams of liquid traveling at different velocities can be observed. This occurs because the stationary pipe exerts a "drag" force—viscous drag—on the moving liquid, attempting to slow it down. The drag force is transmitted to all liquid layers along their parallel surfaces.

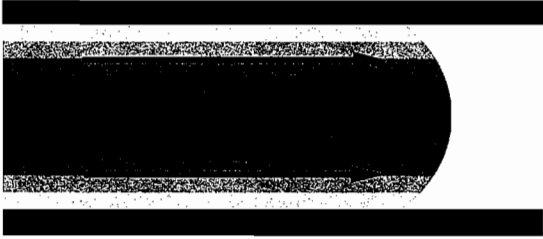

Figure 1. Laminar Flow Through a Pipe.



Figure 2. Turbulent Flow Through a Pipe.

The result is higher liquid velocities at the center of the pipe, and, by Bernoulli's principle, lower pressures in this region, with gradually lower liquid velocities and higher pressures as the layers approach the inner surfaces of the pipe. The layer closest to the pipe—the boundary layer—is at rest, with zero velocity, and is the area of highest pressure (Rosenhead, 1963; Shapiro, 1953).

The same principles apply to rotating discs like those found in the disc pump (Modi and Seth, 1991). The boundary layer—layer "B" next to the disc surfaces—is stationary, *relative to the discs*. (Relative to an *external observer*, of course, this layer travels at the highest velocity.) As the discs rotate, energy is transferred to successive layers of molecules in the fluid between the discs via viscous drag, generating velocity and pressure gradients between the discs. Layer B is stationary and layer 1 is fastest (Figure 3).

The parallel discs that form the pumping mechanism of the disc pump rotate in a plane perpendicular to the pump inlet. As explained above, a boundary layer forms on the disc surfaces, transferring energy from the rotating discs to successive layers of fluid, parallel to the discs. The force that is created by this combination of boundary layer and viscous drag propels the fluid through the pump in a smooth, pulsation-free flow (Figure 4). Since the fluid moves parallel to the discs, it does not impinge on the moving parts of the pump. Note that particles that are heavier than the carrying fluid are harder to accelerate and therefore stay in the slowest moving layers, i.e., the central space between the discs. Therefore they too do not impinge on the discs.

This pumping mechanism distinguishes the disc pump from other pump systems available; it is neither a centrifugal, positive displacement, nor a reciprocating device. However, from the outside, it closely resembles a centrifugal pump, has many of the same hydraulic characteristics, and uses the same type of sealing devices.

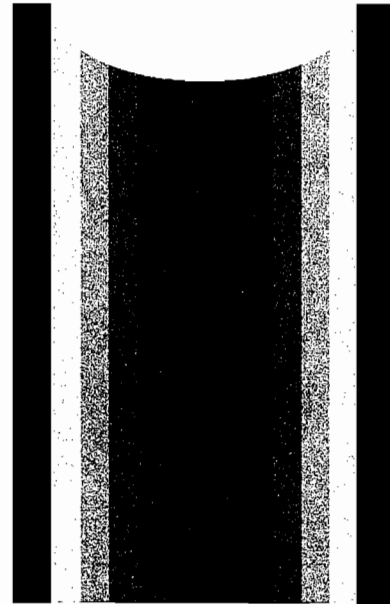

B 5 4 3 2 1 2 3 4 5 B

Figure 3. Relative Speed of Fluid Between Two Rotating Discs.

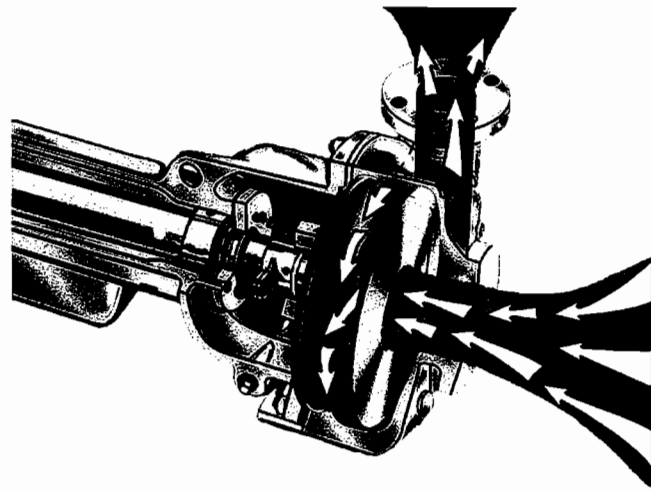

Figure 4. Cross-Section of a Disc Pump Showing Pulsation-Free Flow.

FLUID APPLICATIONS FOR DISC PUMPS

Viscous Fluids

Disc pumps can move fluids with viscosities up to several 100,000 cP. Since there is no pushing device in the disc pump that must overcome the inertia in a viscous fluid in order to pump it, the product "moves itself," using the viscous drag principle to transfer energy between successive layers of fluid, while the layer on the discs (the boundary layer) remains stationary relative to the discs. In addition, to prevent excessive drag between the disc assembly and the front and back of the pump casing, the disc pump is constructed with wide clearances in these areas.

Beyond several 100,000 cP, however, the braking action from the casing is strong enough to prevent the disc assembly from rotating. Furthermore, the disc pump has insufficient suction at this point to pull the product into the pump and overcome the large friction losses in the system.

One unusual aspect of the disc pump in viscous application is the increase in pumping efficiency as viscosity increases. At

viscosities greater than 350 cP, the disc pump is more efficient than a comparatively-sized centrifugal pump in the same application (based on information from the Hydraulic Institute (1994)). This is because, according to the viscous drag principle, energy is transferred between layers of fluid more easily in a viscous material than a nonviscous one. The disc pump is *more efficient* pumping viscous fluids than nonviscous ones.

This phenomenon can be shown graphically. Figure 5 compares the velocity profiles across the disc assembly for fluids with two different viscosities—1 cP (left) and 5000 cP (right). As can be seen on the figure, the more viscous liquid has a lower velocity gradient, and therefore the disc pump would transfer about a 25 percent greater volume of the more viscous fluid for the same horsepower, in effect increasing the pumping efficiency. (Refer to the section, DESIGN AND OPERATING CHARACTERISTICS, and APPENDIX A for information on pumping efficiency in viscous applications.)

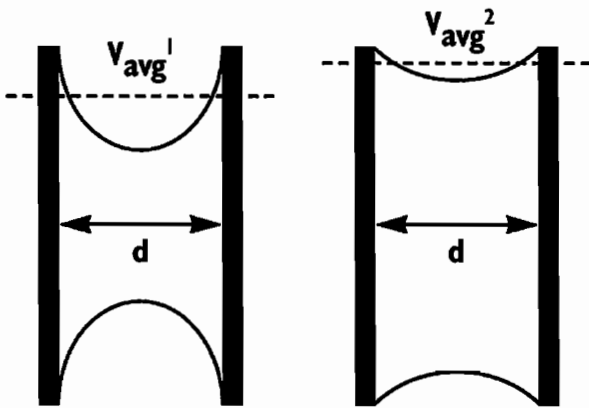

Figure 5. Velocity Profiles Across Disc Assembly for Two Different Viscosities.

Overview of Viscous Application Areas Suitable for a Disc Pump

For viscous applications, the disc pump is suitable for use: in chemical, oil, and petrochemical processing, to pump filter cake slurry, clarifier sludge, waste, and black beauty; in pulp and paper manufacturing, to pump stock with up to 18 percent consistency, green liquor dregs, and lime sludge; in wastewater treatment and disposal applications, to pump primary and secondary clarifier sludge, digested sludge, and lime slurry; in food and sanitary processes, to pump molasses, pet food waste, slaughterhouse waste, and peanut butter; and in mining and environmental cleanup applications, to pump lake bottom mud, metal powder slurries, and hazardous waste.

Pumping Abrasive Fluids

The abrasion resistance of a given pump design can be determined by observing the flow path of a solid as it passes through the pump. If a particle makes contact with a surface, the surface will wear, with the amount of wear being a function of the impingement angle (angle of attack) at which contact is made, the relative velocity between the abrasive particle and surface, and the nature of the substrate (Dickenson, 1995; Hellman, 1984). Figure 6 shows erosion wear rate versus angle of attack for various substrates.

As fluid enters the disc pump, it moves in a path parallel to the rotating discs. As explained earlier, the region of high velocity pressure is on the disc surfaces and the region of lowest velocity is midway between the discs. Apart from the initial uptake of fluid into the pump, once the pump is running, there is no contact or impingement between the pumpage and the discs. With impingement angles close to zero, the discs in the pump therefore

suffer little wear from abrasion during pumping, even in very abrasive service such as pumping fly ash or titanium dioxide.

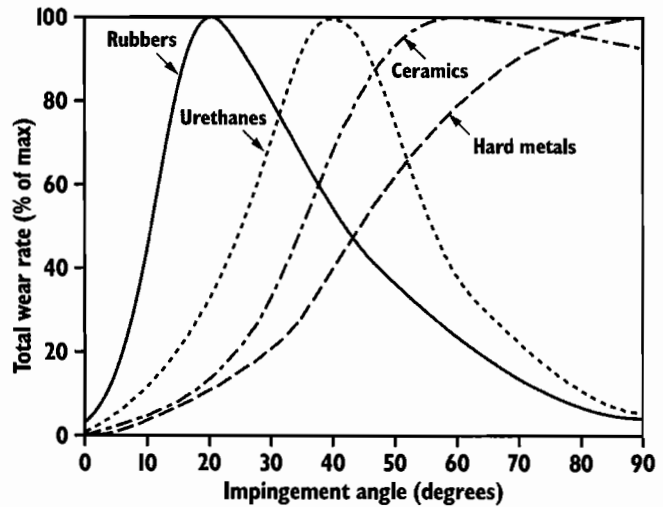

Figure 6. Erosion Wear Rate Versus Angle of Attack for Various Substrates.

Overview of Abrasive Application Areas Suitable for a Disc Pump

For abrasive application areas, the disc pump is suitable for use: in chemical, oil, and petrochemical processing, to pump crystal slurries, debenzonized tar, oil, and sand slurry; in pulp and paper manufacturing, to pump black liquor soap, paper coatings (e.g., titanium dioxide slurry), and fly ash; in wastewater treatment and disposal applications, to pump lime sludge, sand slurry, and carbon black slurry; in food and sanitary processes, to pump sugar slurries, oyster shell slurry, and chicken processing waste (e.g., beaks); and in mining, environmental cleanup, or other applications, to pump borax, diatomaceous earth, steel slag, and drilling mud.

Pumping Slurries with a High Solids Content

The disc pump can move slurries containing up to 80 percent solids, where those solids are nonhomogeneous and nonabsorbing. With these types of slurries, the particles easily fall out of solution due to the solids' higher specific gravity over the carrying fluid. As a nonhomogenous (non-Newtonian) slurry enters the disc pump, the solids' particles move to the point of highest velocity relative to the discs and lowest pressure, i.e., the central space between the discs. The higher the specific gravity of the solids, the more this separation occurs. Onsite testing has shown that slurries containing up to 80 percent solids by volume can be pumped without clogging the system.

Overview of High Solids Application Areas Suitable for a Disc Pump

For high solids applications, the disc pump is suitable for use: in chemical, oil, and petrochemical processing, to pump oil and sand slurries, crude oil and pigment slurries; in pulp and paper manufacturing, to pump knotted rejects, recycled stock, and pigment/paper coating slurries; in wastewater treatment and disposal, to pump raw sewage, sand slurries, and lime slurry up to 80 percent solids; in food and sanitary processes, to pump corn kernel slurries, rice and water, sugar slurries, and vegetable soups; and in mining, environmental cleanup, and other applications, to pump muds, metal powder slurries, and in lake cleanup.

Pumping Fluids with High Volumes of Entrained Air/Gas

The mechanism for pumping fluids with high volumes of entrained air or gas is similar to that for pumping high solids slurries. As air and gas bubbles enter the pump, they travel to the

point of highest velocity relative to the discs and lowest pressure, i.e., the central space between the discs, and do not impinge on the discs. They remain entrained in the fluid and, as they pass into a higher pressure area, some compress (away from the discs) and some pass out of the pump. In certain industrial applications, including chemical froths and products from dissolved air flotation (DAF) tanks, the pump can handle 80 percent gas entrainment.

*Overview of High Volume
Entrained Air/Gas Application
Areas Suitable for a Disc Pump*

For applications with high volumes of entrained air/gas, the disc pump is suitable for use: in chemical, oil, and petrochemical processing, to pump DAF sludge, crude oil with gases, and chemical froths; in pulp and paper manufacturing, to pump stock with up to 30 percent entrained air, and black liquor soap; in wastewater treatment and disposal, to pump anaerobic sludge and DAF sludge; in food and sanitary processes, to pump products prone to frothing, e.g., egg whites; and in mining, environmental cleanup, and other applications, to pump various materials.

Pumping Delicate and Shear Sensitive Fluids

The disc pump has been applied in the pumping of delicate and shear sensitive fluids. In this context, delicate fluids includes any fluid containing large, soft solids, such as tomatoes, grapes, or rice, which can bruise or damage on impact, or easily breakable solids, such as chemical crystals.

The evidence for the disc pump's ability to move these products without breakage is largely experimental. We have conducted tests using a clear plastic model disc pump that shows that these solids position themselves equidistant from the discs in the disc assembly. Using strobe lighting, we have found that at concentrations of solids up to 40 percent, there is no contact between the product and pump. Inspection of the product after recirculation through the pump has verified the lack of damage to these delicate products.

As explained earlier in the sections on pumping high solids slurries and air-entrained fluids, the solids do not impinge on the disc assembly but pass through the pump in the area of highest velocity relative to the discs and lowest pressure, i.e., the central space between the discs. The impingement angle of the solids as they enter the pump is close to zero, so even if contact is made between the pump and pumpage on entry, it is not sufficient to cause damage to the product. It is imperative, however, in these applications that the disc assembly is correctly sized for the largest solid, in order to prevent clogging.

In the case of pumping shear sensitive fluids, i.e., dilatant and thixotropic fluids, the disc pump mechanism has been shown not to cause excessive shear to the product. In part, this is because the pump is used most often with high viscosity fluids: these types of fluids require a greater force to shear at a given rate than low velocity fluids (Figure 7). Also, since there are no sudden changes in direction of the fluid path through the pump and flow is laminar rather than turbulent, the shear rate is further reduced. In fact, we have found that the shear rate through the disc assembly is less than in the discharge pipe.

Similarly, for pumping emulsions, the disc pump has been shown not to cause emulsification in the fluid. Testing was carried out on behalf of a customer at an independent testing company. The tests were designed to find the most suitable pump for a membrane belt filter application. The amount of emulsification, shearing, and dissipation each pump caused when a solution of detergent, oil, and water was circulated for 30 minutes was investigated, and then a sample filtered through the membrane. The pump with the least disturbance was considered the best candidate for use with the membrane belt filter. The results are given in APPENDIX B. The disc pump proved to be the most successful, producing no visible shearing after 30 minutes and no emulsification of the oil/water fluid.

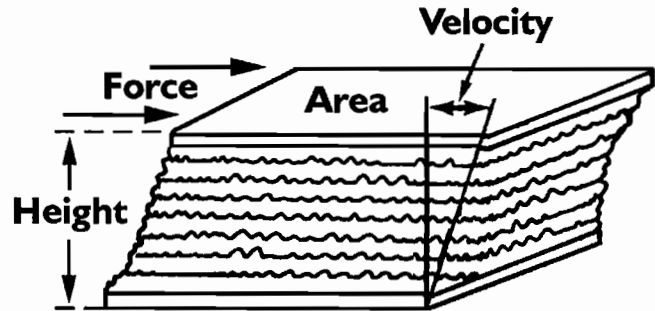

Figure 7. Parameters Determining Shear in Fluids.

*Overview of Delicate and Shear Sensitive
Application Areas Suitable for a Disc Pump*

For delicate and shear sensitive applications, the disc pump is appropriate for use: in chemical, oil, and petrochemical processing, to pump crystal slurries, water/oil emulsions, and crude oil; in pulp and paper manufacturing, to pump paper stock, bentonite solution, dilatant and thixotropic pigment slurries; in wastewater treatment and disposal, to pump polymer solutions; in food and sanitary processes, to pump delicate foodstuffs such as whole corn, grapes, etc., blood, and catalyst solutions; and in mining, environmental cleanup, and other applications, to pump various materials.

DESIGN AND OPERATING CHARACTERISTICS

Disc Pump Design

A cross-section of the disc pump is given in Figure 8. It is very similar to a centrifugal type pump and, like a centrifugal unit, follows the Affinity Laws very closely when pumping a Newtonian fluid. The disc pump also uses the same type of packing and seal arrangements as a centrifugal pump. A double back-to-back mechanical seal is standard, although the pump can incorporate any ANSI or API seal or box. Different seal arrangements are given in Figures 9 and 10.

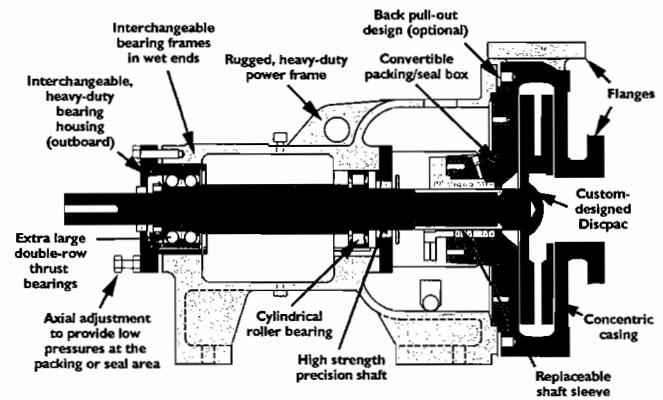

Figure 8. Cross-Section of a Disc Pump.

In viscous and abrasive applications, expeller ribs are used on the back of the disc assembly, facing the stuffing-box. This reduces stuffing-box pressure and protects the seal from damage. Testing has also shown that the disc pump has no radial loads (refer to APPENDIX C); this further protects the seal from damage and decreases the chance of seal failure in hard-to-pump applications.

One key difference between a disc pump and a centrifugal pump is that the disc pump uses a tangential discharge. This is designed to maintain a more even radial load around the pump shaft. Testing has shown that the shaft deflection of a disc pump is typically 85 percent of an equivalently sized centrifugal pump. Results and experimental data are given in APPENDIX D.

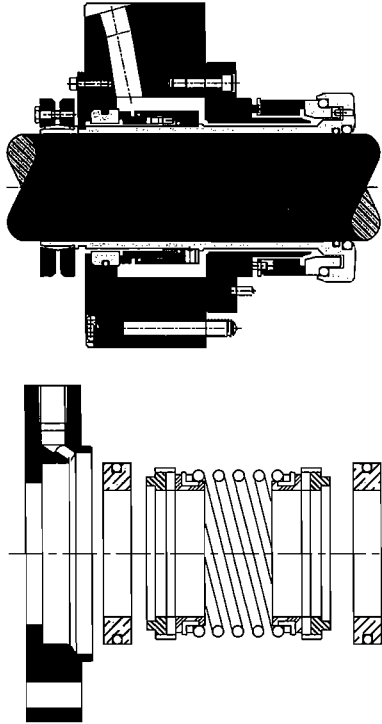

Figure 9. Type 1 and Type 21 Mechanical Seals.

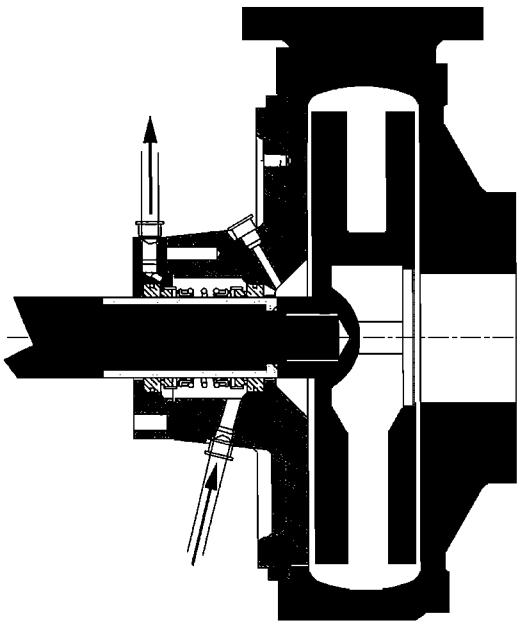

Figure 10. Double Mechanical Seal with External Flush.

Disc Assembly

The disc assembly—the pumping mechanism inside the disc pump—can be configured to meet fluid and hydraulic conditions by varying the number, size, and spacing of discs. Typically, the assembly comprises two discs, with standard disc diameters of 8 inches, 10 inches, 12 inches, 14 inches, 17 inches, and 20 inches and metric equivalents. The spacing between the discs is determined by the size of solids to be passed, and the nature of the fluid (shear sensitivity, viscosity, air-entrainment level, etc.).

There are two designs of disc assembly available—one using entirely smooth discs (Figure 11), and the other, more recent design, using ribbed discs (Figure 12). The latter, developed in

1988, incorporates a number of straight radial or curved ribs on the inside (opposing) surfaces of multiple disc configurations. This design produces higher flowrates and discharge pressures than comparably sized smooth discs, and is called a “high head” disc.

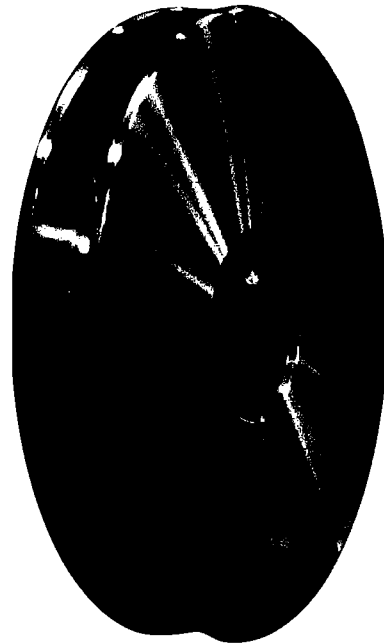

Figure 11. Smooth Disc Assembly.

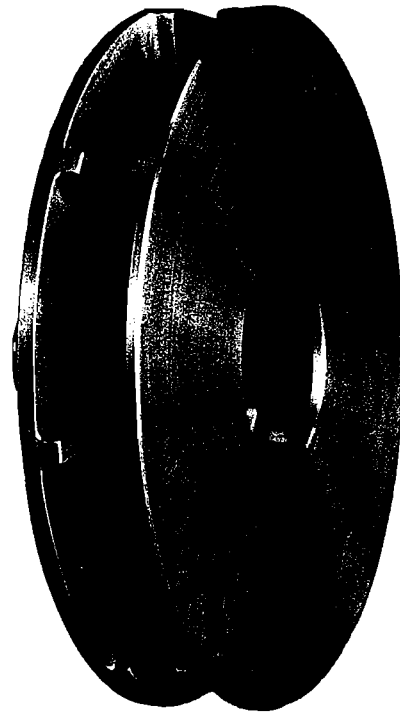

Figure 12. Ribbed Disc Assembly.

The ribbed design can be compared to a corrugated pipe. The corrugations or ribs increase friction and hence increase efficiency, without disturbing the laminar flow. The ribs effectively increase the thickness of the boundary layer, so not only does the “nonimpingement” principle still apply, but it is in fact reinforced by having a thicker, more protective buffer between the fluid particles and the discs.

NPSH Requirement

The net positive suction head (NPSH) required for the disc pump depends on several factors, including type of inlet, disc assembly design, pump flow, operating speed, nature of the liquid being pumped, etc. Reductions in head occur between the suction flange of the pump and the low pressure point, which for disc pumps is the eye of the disc assembly. Friction, turbulence, and entrance losses prior to the disc pump all effect the NPSH required by a pump. Furthermore, it is known that for any pump, the more laminar the flow, the lower the required NPSH ($NPSH_R$ (R is for required)) (Dickenson, 1995).

The available NPSH must be greater than the $NPSH_R$ for a pump or cavitation can result (Dickenson, 1995). Cavitation, with a reduction in head and capacity, usually accompanied by excessive noise and vibration in the pump, occurs when liquid in the low pressure area of the pump vaporizes due to insufficient $NPSH_A$ (A is for available), forming vapor bubbles, which then implode as they pass to regions of higher pressure. If the bubbles implode near an adjacent surface—for example near the vaned impeller in a centrifugal pump—a tremendous shock wave can result from the inrush of liquid into the cavity left by the bubbles. The shock wave can remove molecules of metal, causing pump parts to look badly corroded and sponge-like. The energy expended in accelerating the liquid to high velocity to fill the void left by the bubbles is a loss causing the drop in capacity associated with cavitation.

Since disc pumps operate with the boundary layer/viscous drag principle to produce a smooth, laminar flow within the pump, there is a minimal pressure drop between the pump inlet and the eye of the pump, so that the resulting NPSH required by a disc pump is about half to a third that required by a standard centrifugal pump for the same service conditions. Furthermore, with a disc pump, the $NPSH_R$ curve is stable right to shut off. Observation of transparent disc pumps has demonstrated that there is little to no prerotation in the suction end of the pump; this further contributes to extremely low NPSH values. Finally, the effects of cavitation and implosions are minimized in disc pumps by the layers of fluid near the discs in the pump, which act as a buffer or “shock absorber,” so that even under low NPSH conditions, disc pumps suffer little to no wear.

The NPSH curve for a disc pump is shown in Figure 13. It is operating under the following conditions:

- Fluid: water (viscosity = 1 cP; specific gravity = 1.00; temperature = 80°F; no solids, no entrained air)
- Capacity: 358 gpm; TDH: 84 ft
- Type of disc pump used: 402-14-2HHD with disc assembly trimmed to 13.45 inches
- Power: 16 hp; rpm: 1160; efficiency: 47.50 percent

Performance Curves

There are two types of performance curve that characterize the disc pump. The first is a steep sloping H-Q curve, which applies to the original smooth disc assembly design (Figure 14). The second is a flatter H-Q curve, which applies to the second generation, “high head” disc assembly design (Figure 15). Also, compare the performance curve in Figure 16, with the performance curve for Figure 17; the former uses a 5D (i.e., smooth discs) and the later a model 2HHD (i.e., “high head” discs), for the same fluid and operating conditions.

The performance curves for the disc pump are generally flatter than those of other pump types. This means the pump is more sensitive to changes in head, and a higher degree of accuracy is required when specifying flow conditions than for an equivalent centrifugal pump. For example, if a disc pump is designed for 110 ft head because the engineer has factored in a 10 percent safety margin for a 100 ft head application, the pump will operate much further to the right of the performance curve. In other words, small variations in head will cause wide variations in performance.

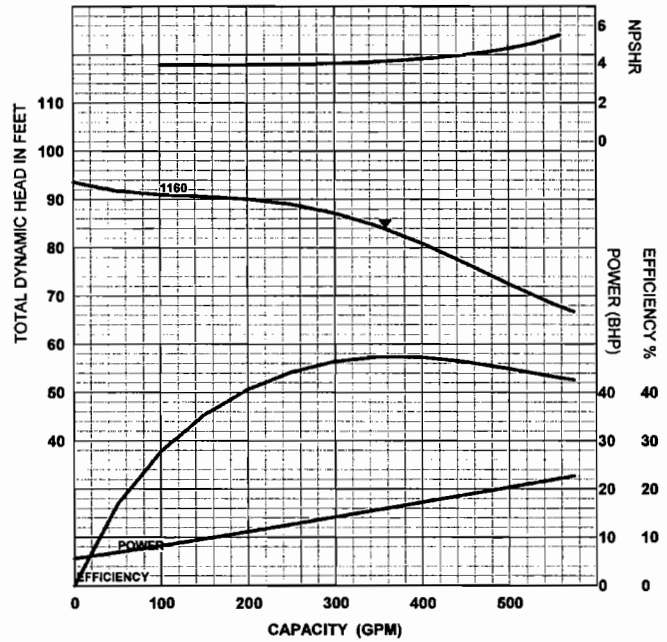

Figure 13. NPSH Curve for a Disc Pump.

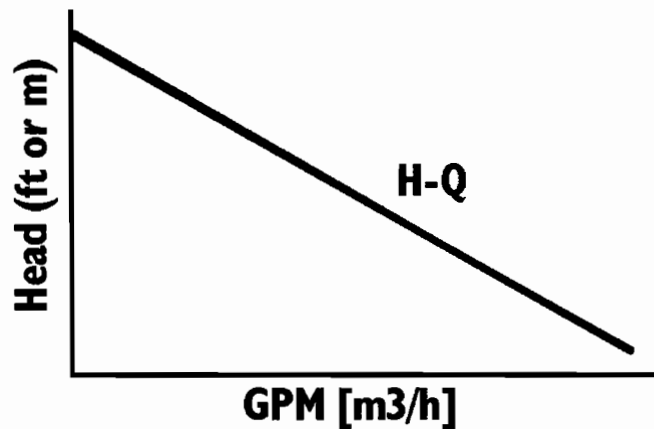

Figure 14. Performance Curve for a Smooth Disc Assembly.

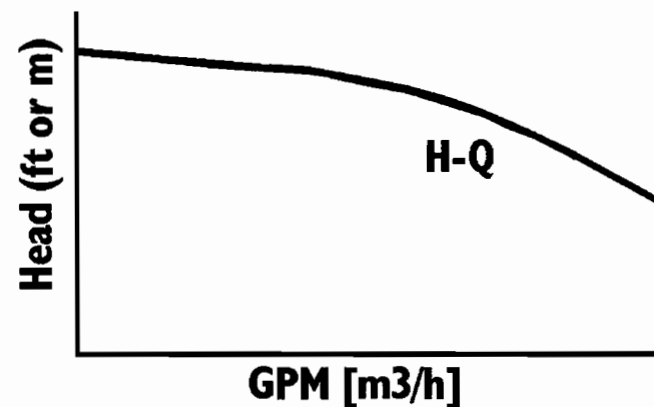

Figure 15. Performance Curve for a Ribbed Disc Assembly.

The maximum discharge head for a disc pump is 1000 ft with a standard model. The maximum flow is 8000 gpm with a standard pump model. Disc pumps can be engineered to achieve higher flowrates if required by the application.

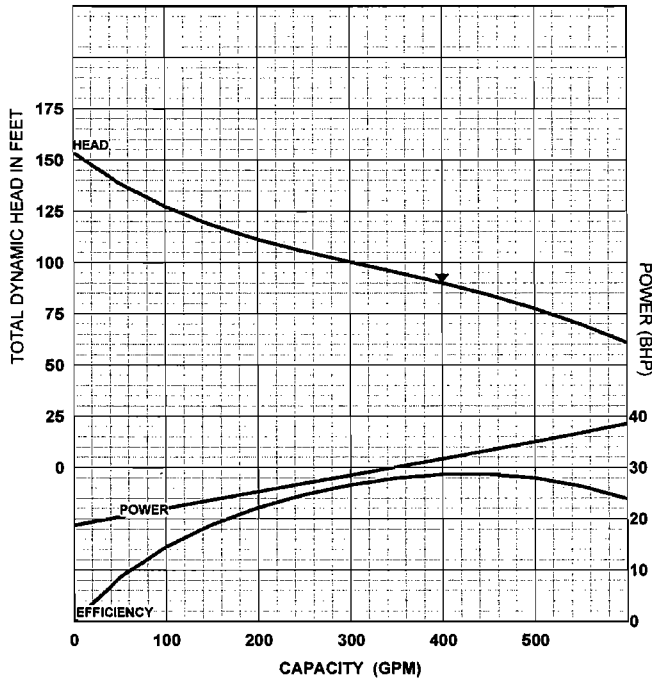

Figure 16. Performance Curve for a 5D Smooth Disc Assembly.

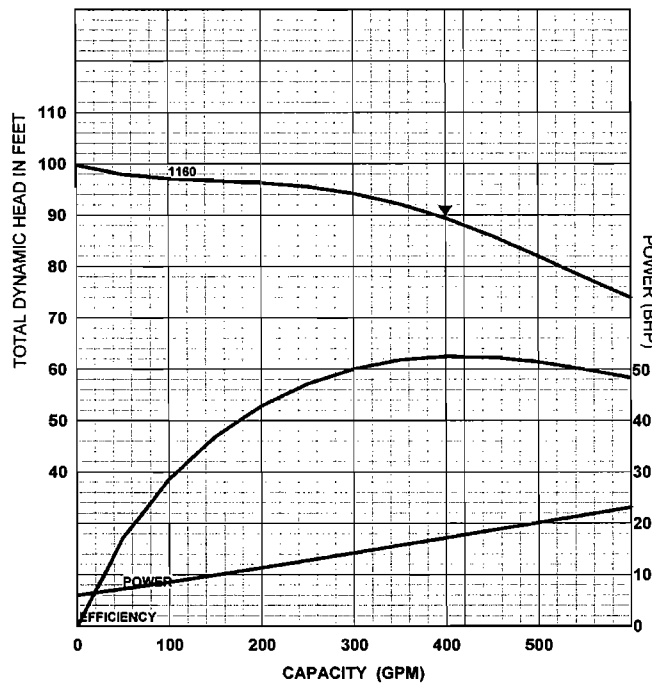

Figure 17. Performance Curve for a 2HHD Ribbed Disc Assembly.

Pumping Efficiency

As stated earlier, the disc pump is less efficient than a comparably sized centrifugal pump in nonviscous applications. The best efficiency point can often fall below 30 percent. Therefore the disc pump is not marketed to these applications, unless there is another “problem” with the fluid, such as sensitivity to shear, high level of entrained air, severely abrasive content, or frequent clogging by solids, which would override the user’s concerns with low efficiency. The disc pump’s low efficiency in these conditions is due partly to the inefficiency of energy transfer in the viscous drag process and partly due to the wide clearances in the pump.

In viscous applications, the best efficiency point usually falls between 40 percent and 55 percent, but can be as high as 60 percent. APPENDIX A gives a comparison between pumping a 660 cP fluid for a disc pump and a standard ANSI centrifugal pump. It demonstrates the higher efficiency of the disc pump at these higher viscosities. The performance curve for the viscous fluid (660 cP) is given in Figure 17 and the equivalent curve for water is given in Figure 13. Operating conditions are given in APPENDIX A.

Pump Clearances

The disc pump is engineered with wide clearances because all the surfaces of the disc assembly are involved in pumping. This design has both advantages and disadvantages. On the one hand, it reduces the chance of clogging, it allows the pump to handle the problem fluids for which it is most suited, e.g., viscous slurries, fluids with a high solids content, shear sensitive fluids, etc.—and it allows efficiency to remain constant as internal parts wear. On the other hand, the lack of tight clearances in the design reduces pump efficiency compared to an equivalently-sized centrifugal pump: in effect, the pump is “worn out” when it is installed.

END-USER’S EXPERIENCE WITH THE DISC PUMP

Background Information

The refinery to be discussed is a joint venture between two major oil companies and is the largest oil refinery in Kansas, rated at 110,000 barrels/day of crude oil processing capacity. The primary finished products are motor fuels: gasoline, diesel, aviation gasoline, and jet fuel; and chemicals: phenol, cumene, sulfur, propane, and others. There are approximately 400 employees at the plant, together with 150 contractors.

This paper’s coauthor has been working at the refinery for nine and a half years as a staff reliability engineer. He is responsible for improving the plant’s overall mechanical reliability. He was the first to recommend the use of disc pumps at the plant and has seven years’ experience with this type of pump. The maintenance schedules for the disc pumps installed at the refinery are given in APPENDIX E.

First Disc Pump Applications—

Sludge Oil Transfer and CPI Oil Transfer

The first disc pumps were installed at the plant in 1993 for sludge oil transfer (Figure 18) and corrugated plate interceptor (CPI) oil transfer (Figure 19) at the wastewater treatment unit. In the six years since startup, the pumps have performed well: very little maintenance has been required and there has been no unplanned downtime due to pump failure.

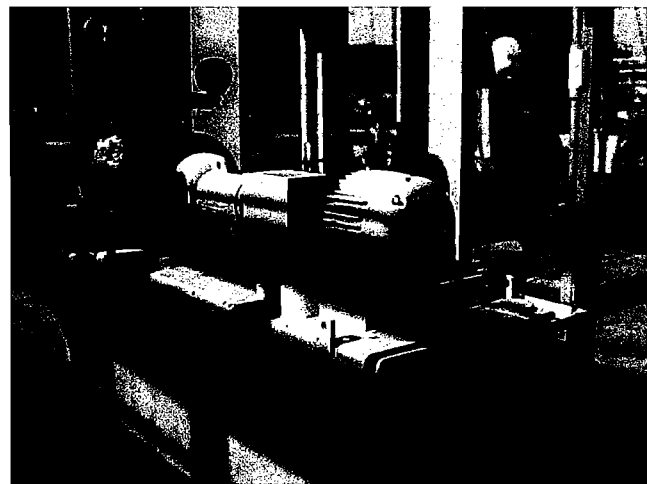

Figure 18. Disc Pump at a Refining Company Pumping Sludge Oil.

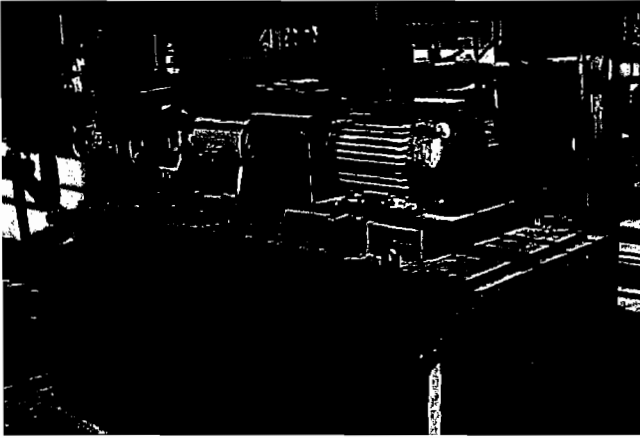

Figure 19. Disc Pump at a Refining Company Pumping CPI Oil.

The fluid in the sludge oil transfer operation is moderately viscous (40 cP) with no solids, and has a specific gravity of 0.877. The oil is in an emulsion state, making it difficult for a centrifugal pump to handle. But the disc pump's laminar, pulsation-free flow allows it to pump the fluid without losing prime and without cavitating.

Two 402-14-2HHD (four inch suction and two inch discharge) disc pump models, with a disc assembly trimmed from 14 inches diameter to 12.95 inches, were installed in March 1993. Each unit is on a Texaco Type API base and uses a John Crane Type 1100 cartridge seal with an oil bearing frame. The casing, stuffing-box, and shaft sleeve are constructed of 316 SS and the disc assembly is Norchrome. The units each have a 20 hp three-phase totally enclosed fan-cooled (TEFC) motor, running at 1750 rpm. The pump conditions are 100 gpm at 50 psig with a flooded suction.

In the CPI oil transfer application, the disc pump must move a heavy slop oil containing some solids—grit, dirt, etc. The fluid is somewhat abrasive and viscous (40 cP), with a specific gravity of 0.877. A pump model similar to that used in the sludge oil transfer operation is employed. The only difference is the use of a flat disc assembly, trimmed from 14 inches to 13.75 inches in diameter. The pump conditions are 50 gpm at 40 psig with a flooded suction.

The three pumps installed in 1993 were new units and did not replace any previous pumps. However, for similar oil sludge applications at the plant, the company has used centrifugal-type pumps and has encountered problems with erosion due to solids and operating problems due to the changes in pumpage composition and viscosity. Based on the above experience, the plant has found disc pumps to be a better fit for oil sludge applications.

Second Disc Pump Application— DCU Coke Drum Condensate Pump

In this application, a disc pump is moving coke drum condensate, a very hot, abrasive fluid containing coke fines, gas oil vapor, and some steam. The fluid's specific gravity is 0.645. The condensate is produced by injecting oil into a cold drum, where it condenses to a hot, light gas oil. Once the skin temperature of the drum reaches 500°F, pumping is stopped. The main problems in pumping the condensate is the entrained gas from the gas oil and flashed quench water.

Originally, the company used a steam-driven reciprocating pump in this application. It had been in place for 40 years and was becoming increasingly unreliable. In September 1996, it was replaced by a disc pump (Figure 20). A horizontal end-suction model 403-20-2HHD was chosen, with the disc assembly trimmed from 20 inches to 18.3 inches. This pump was one of the first high temperature API centerline-mounted pumps built by a major manufacturer. The bearing frame is cast steel and the disc pack is 440C stainless steel, heat-treated to 58 RC. The pump incorporates a double cartridge mechanical seal, API medium cooled, suitable

for high temperature service. The pump has a 150 hp motor in an explosion-proof enclosure, running at 1750 rpm.

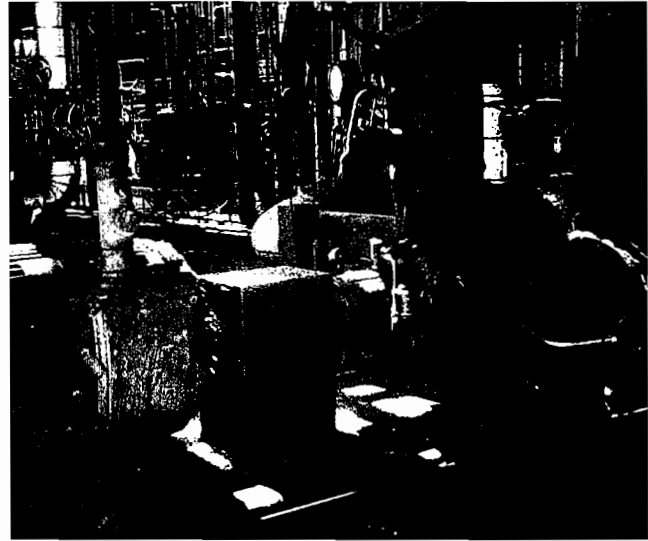

Figure 20. Disc Pump at a Refining Company Pumping Coke Drum Condensate.

The plant initially encountered some problems with the disc pump because the pump was not matched correctly to the system conditions. The pump was designed for a flowrate of 265 gpm at 260 ft TDH. However, these are maximum conditions and, in reality, the required head is closer to 100 ft. However, because of the disc pump's performance characteristics, i.e., it has a flatter H-Q curve than a comparative centrifugal pump, the desired head cannot be achieved directly by throttling the pump discharge. Therefore, to solve the problem, a variable frequency drive (VFD) will be installed on the pump.

Third Disc Pump Application— Heavy Slop Oil Charge to Crude Pump

The most recent disc pump to be installed at the Kansas plant is for pumping a heavy API sludge and slop oil mixture (Figure 21). The heavy slop contains all the hydrocarbons from the slop and any solids that have entered the process. It is stored in four holding tanks and a pump then transfers this slop back into the supply line for the crude oil.

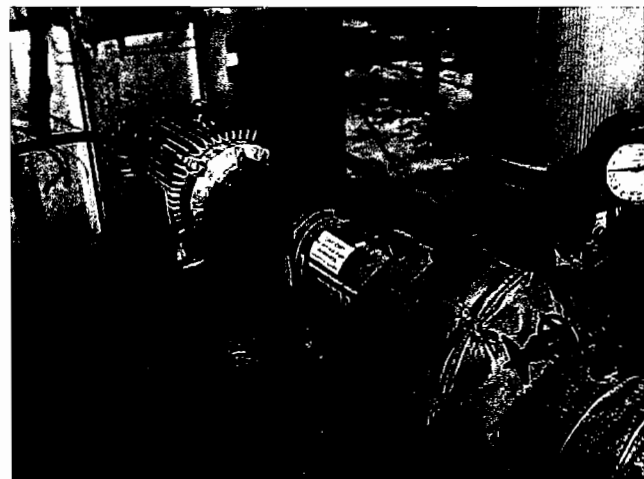

Figure 21. Disc Pump at a Refining Company Pumping Heavy API Sludge and Slop Oil Mixture.

The challenge in pumping this fluid is the variation in fluid conditions. At different times, the viscosity, solids concentration and size, suction pressure, and flowrate can all vary: the viscosity can be as high as 200 cP or as low as 1 cP; the solids content can include sand, pieces of plastic, and anything that enters the system earlier in the process; the pressure in the discharge line can swing by as much as 20 to 25 psig; and the flowrate can reach a high of 2000 barrels/day (58 gpm) or a low of 450 barrels/day (13 gpm).

For 40 years, the work of moving the slop oil had been performed by a reciprocating steam-driven pump. It had become, in the words of the coauthor, "a reliability nightmare," generating over 30 work orders for maintenance in its final year of operation. The company then installed two electrically-driven centrifugal pumps operated in series to replace the old pump. These also proved unreliable; the solids in the slop oil would frequently clog the pump, causing either seal failure or loss of prime in the pump.

Next, the company tried a skid-mounted, self-priming centrifugal pump. It was an improvement over the previous centrifugal pumps in that it had sufficient prime, however, the pump still suffered frequent seal failure due to clogging and loss of seal flush. By that point, the coauthor says they were desperate. The slop oil transfer is a critical application and must be kept moving to ensure that the plant remains running. The coauthor suggested using a disc pump.

A 402-14-2HHDL model horizontal end-suction pump, with disc assembly trimmed to 11.26 inch diameter, was installed in December 1997. It was constructed in CD4MCU, with an API base, and the disc assembly was Maxalloy 350. The unit had a 40 hp explosion-proof motor, running at 3450 rpm and a John Crane Type 2800E dry running gas cartridge seal.

Because of the problems with discharge pressure they had experienced with the coke drum condensate disc pump, the coauthor decided to let one of their senior process engineers specify the required discharge pressure for the new pump. The engineer came up with a discharge of 429 ft TDH. The pump was therefore designed with a capacity of 35 gpm at 429 ft TDH (185 psig).

However, this was a "worst case" value and, in reality, the system needed only 110 to 130 psig of pressure. To compound the problem, the horsepower for the pump had been chosen based on a specific gravity for the pumpage of 0.7. Subsequent testing found the value closer to 1.0, requiring a higher horsepower motor. Therefore the pump was underpowered and pulling too much amperage.

To reduce the amperage, the engineers restricted the discharge pressure/flow. While this solved the amperage problem, it created another hazard; the light hydrocarbons in the pumpage, which were already hot (150°F), stayed too long in the pump, heated up and, once they reached their flashpoint, turned to vapor. As the gas built up in the pump, it would lose discharge pressure entirely. There was also a problem with the suction side design; the suction line created a trap and had too much friction loss due to elbows.

Solving the Problems

The first task was to improve the suction line by installing a direct line between the suction header line from the tanks to the disc pump. This ensured there was sufficient suction pressure.

The problem of the underpowered motor could only be partially solved. Ideally, a 60 hp motor was required, instead of the 40 hp specified. However, in order to leave the electrical system unchanged, the electrical maintenance department installed a 50 hp motor.

The real key to solving the pump's problems was to install an inverter. By using an inverter, the pump was able to be operated closer to 40 hp and still achieve the lower discharge pressures required. Tuning the inverter to the optimum level also solved the excess amperage problem and reduced it to the 42 to 45 amps range, while getting the discharge pressure down to 110 to 130 psig.

They successfully proved to their very skeptical management that the disc pump would work in this application. The inverter was installed in February 1998. Since then, the pump has performed well.

CONCLUSION

The disc pump technology is unique in pump technology, differing from all other types of pump on the market. Its method of operation—using solely boundary layer and viscous drag principles—makes it a good fit for problem applications, including viscous fluids, abrasive fluids, slurries with a high solids content, fluids with entrained air or gas, and delicate and shear sensitive fluids. By minimizing contact between the pump and pumpage, and generating a laminar, pulsation-free flow through the pump, it can reduce the incidence of pump failure and seal failure, reduce excessive wear from abrasion or cavitation, and prevent damage to delicate and shear sensitive fluids. The disc pump does, however, have a lower pumping efficiency than comparable centrifugal pumps and is therefore not marketed for nonviscous, nonproblem applications.

APPENDIX A— COMPARING THE EFFICIENCY OF A DISC PUMP AND STANDARD ANSI CENTRIFUGAL PUMP IN PUMPING A VISCOUS FLUID

The application requirements are 400 gpm at 90 ft TDH. The product viscosity is 3000 SSU (equivalent to 660 cP), and a specific gravity of 1.0. For comparison, a typical ANSI 3×4×13 A40 ANSI centrifugal pump at 1770 rpm has been selected. The performance curve for the centrifugal pump is given in Figure A-1, and for the disc pump it is given in Figure 17.

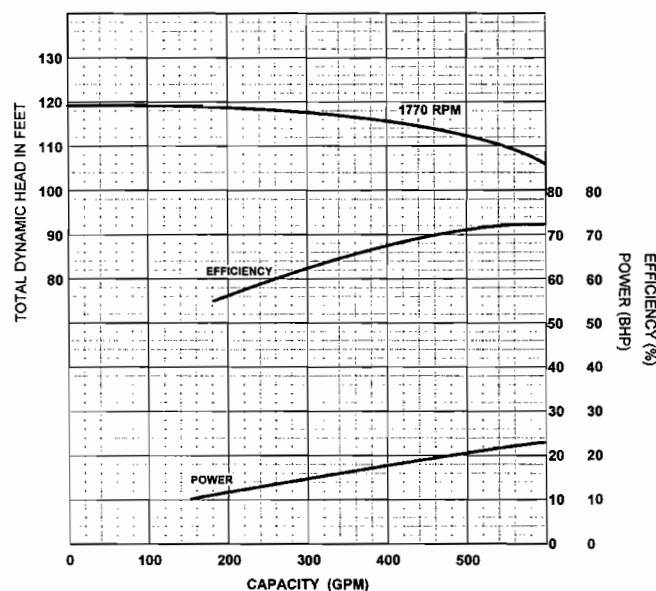

Figure A-1. Performance Curve for an ANSI 3×4×13 A40 ANSI Centrifugal Pump at 1770 RPM.

Viscosity Correction for Centrifugal Pump

Following the procedure from the Hydraulic Institute (1994), the corrected water conditions for the selected centrifugal pump to obtain the required viscous liquid performance is 520 gpm at 113 ft. Therefore, the 3×4×13 pump selected requires a 10.5 inch impeller and has a water efficiency of 72 percent. The viscosity correction factors are as follows:

- $C_H = 0.8$ (head)
- $C_Q = 0.77$ (capacity)
- $C_E = 0.33$ (efficiency)

ANSI pump corrections for 3000 SSU (660 cP):

- Water capacity = $400 \div 0.77 = 520$ gpm
- Water head = $90 \div 0.8 = 113$ ft

- Viscous efficiency = $0.71 \times 0.33 = 0.23$ (23%)

Note: The centrifugal pump is oversized to achieve viscous operating conditions.

To achieve 520 gpm at 113 ft, the efficiency from the water performance curve is 72 percent. The viscosity correction factor defined by the Hydraulic Institute (1994) is 0.33, giving a horsepower requirement of:

- Centrifugal pump estimated hp:
 - $BHP = \frac{400 \times 90 \times 1}{3960 \times 0.23} = 39.5$ hp

Viscosity Correction for Disc Pump

To obtain a viscosity correction for the disc pump for 3000 SSU (660 cP), the authors used the formula defined in the *Discflo Pump Handbook* (Benson, 1999):

- Water capacity = $400 \div 1.12 = 358$ gpm
- Water head = $90 \div 1.07 = 84$ ft

Note: this pump is undersized to achieve viscous operating conditions.

The required disc pump is a 402-12-2HHD model (four inch suction and two inch discharge) with the disc assembly trimmed to 13.5 inches. Using the viscosity corrections from the *Discflo Pump Handbook* (Benson, 1999):

- Viscous capacity = $358 \times 1.12 = 400$ gpm
- Viscous head = $85 \times 1.07 = 90$ ft
- Viscous hp = $16.0 \times 1.18 = 18.9$ hp

Disc pump estimated efficiency:

- $EFF = \frac{400 \times 90 \times 1}{3960 \times 18.9} = 48\%$

CONCLUSION

The centrifugal pump will require a 50 hp motor using approximately 38 hp at the operating point. The disc pump will require a 25 hp motor and will consume 18.9 hp, approximately 53 percent less power consumption, and a 50 percent smaller motor. It should be noted that the gap would be much greater pumping a more viscous fluid.

APPENDIX B

Table B-1. Testing Emulsification for Pumping an Oil/Water Fluid Through a Membrane Belt Filter.

Type of Pump	Result
Centrifugal	Oil completely emulsified after 15 minutes and no flow through the filter.
Diaphragm	Oil was broken into small islands (dissipated) but not really emulsified. Filtered through okay.
Lobe	No oil visible on water surface after 30 minutes but filtered through the membrane—dissipated but not completely emulsified.
PC 1	Oil appeared to be completely emulsified after 15 minutes and would not flow through the filter.
PC 2	After 30 minutes, there were a few oil droplets on the water surface but most had emulsified. Less than half of sample was filtered through.
Disc	No visible shearing after 30 minutes—oil still formed large slicks on water surface. Filtered through in the fastest time.

**APPENDIX C—
MEASURING RADIAL LOADS ON DISC PUMP**

Testing was carried out at the manufacturer’s facilities in May 1998, to measure radial loads on the disc pump under normal running conditions. Pressure was measured at five points on the outside diameter of a model 604-14-2HHD disc pump case (Figure C-1) running at 1750 rpm. The results are given in Table C-1.

Table C-1 shows almost equal pressures at the five points around the casing at varying capacities, demonstrating that there are no significant radial loads on the disc pump under normal running conditions. The lack of radial loads leads to longer seal life and bearing life.

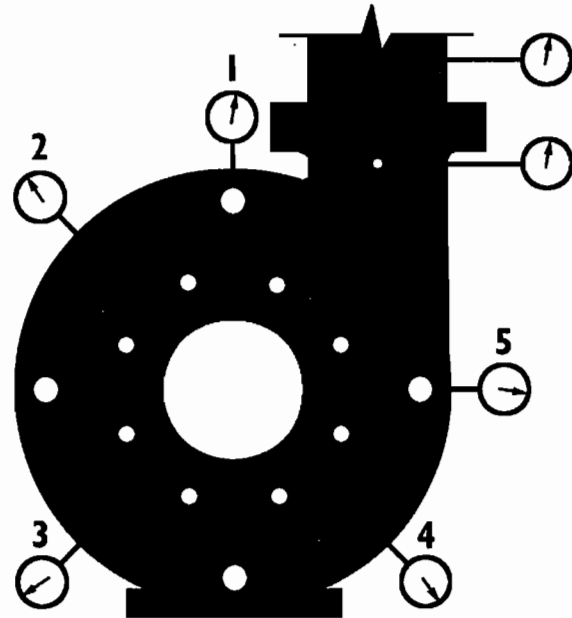

Figure C-1. Pressure Measured at Five Points in a Model 604-14-2HHD Disc Pump at 1750 RPM.

Table C-1. Radial Pressure in PSI from Five Gauges Located on Casing of Disc Pump.

Capacity	Gauge 1	Gauge 2	Gauge 3	Gauge 4	Gauge 5
Shut off (0%)	55	55	55	60	60
25%	50	50	50	50	50
50%	40	40	40	35	35
75%	30	30	40	40	30
Full open (100%)	20	30	30	40	45

**APPENDIX D—
MEASURING AXIAL LOADS ON DISC PUMP**

It was predicted that because the front and back surface areas of the disc assembly are approximately the same, the pressure within the disc pump case would be uniform, resulting in very low axial loads. Tests on a 604 disc pump, carried out in May 1998, measuring the pressure at various points in the pump case during operation have confirmed this theoretical prediction. The experimental setup is shown in Figure D-1. Pressure in psi from eight gauges located on various points around the wet end of the disc pump, measured while pumping water at a pump speed of 1770 rpm is shown in Table D-1. (Note: Axial loads are defined as the forces that apply along the longitudinal axis of the pump. They result from unequal pressure distribution inside the pump, acting in the direction of the shaft. These forces affect the thrust bearings that hold the shaft in position, and high axial loads lead to shortened bearing life.)

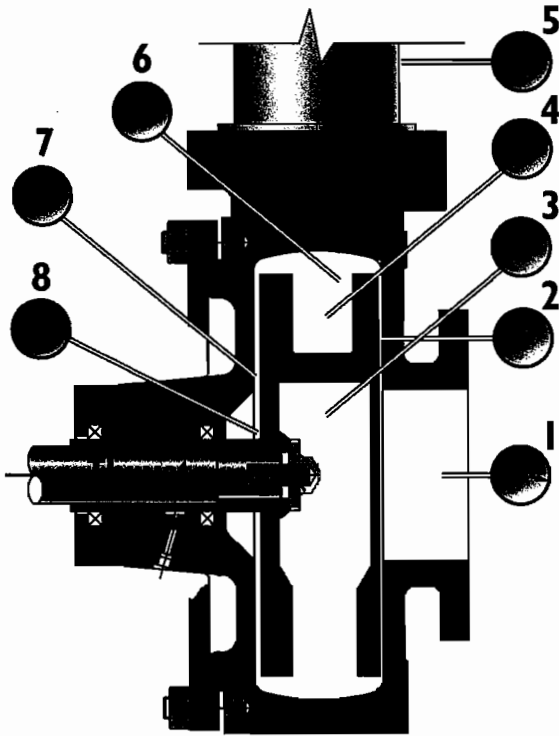

Figure D-1. Axial Loads Measured in a Model 604 Disc Pump.

Table D-1. Pressure in PSI from Eight Gauges Located on Various Points Around the Wet End of the Disc Pump.

Capacity	Gauges							
	1	2	3	4	5	6	7	8
Shut off (0%)	-3	48	-3	48	95	68	40	95
25%	-5	35	-5	35	70	50	30	70
50%	-5	30	-5	30	60	41	22	60
75%	-5	30	-5	30	60	39	17	60
Full open (100%)	-3	28	-3	28	55	33	10	55

APPENDIX E

Table E-1. Scheduled Maintenance Costs for Disc Pumps Installed at a Kansas Refining Company.

Pump service	Number of Work Orders	Mean Time Between Failures (years)	Total Cost (dollars)
Sludge oil transfer (A)	1	6	18
Sludge oil transfer (B)	2	3	6864
CPI oil transfer	6	1	11,676
DCU coke drum condensate	2	1.5	11,153
Heavy slop oil charge to crude	5	0.3	17,949

REFERENCES

Benson, S. J., 1999, *Discflo Pump Handbook*, Discflo Corporation.

Dickenson, T. C., 1995, *Pumping Manual*, Ninth Edition, Oxford, England: Elsevier Advanced Technology, pp. 637-640.

Hellman, D. H., September 1984, "The Influence of the Size of Submersible Pumps on Efficiency and Erosion Wear," *World Pumps*, p. 317.

Hydraulic Institute, 1994, "American National Standards for Pumps," e.g., ANSI/HI 1.1-1.5-1994, ANSI/HI 1.6-1994, ANSI/HI 2.1-2.5-1994, ANSI/HI 2.6-1994, ANSI/HI 9.1-9.5-1994.

Modi, P. N. and Seth, S. M., 1991, *Hydraulics and Fluid Dynamics*, Tenth Edition, Delhi, India: Standard House Book.

Rosenhead, L., 1963, *Laminar Boundary Layer*, New York, New York: Dover Publications Inc.

Shapiro, A. H., 1953, *Dynamics and Thermodynamics of Compressible Fluid Flow*, New York, New York: John Wiley & Sons.