

CONTROL OF BACKFLOW AT THE INLETS OF CENTRIFUGAL PUMPS AND INDUCERS

by

Donald P. Sloteman

Project Engineer

Paul Cooper

Senior Staff Researcher

and

Jules L. Dussourd

Assistant Director and Manager,

Fluids/Thermo Department

Ingersoll-Rand Research, Incorporated

Princeton, New Jersey



Donald P. Sloteman is a Project Engineer at the Ingersoll-Rand Research Center in Princeton. His role in various product development programs includes the design, test, evaluation and performance analysis of pumps and turbines. The product development programs include a high speed inducer feed pump line, hydraulic power recovery turbines, boiler feed pump inlet improvement and centrifugal slurry pumps. He received the

B.S. in Mechanical Engineering degree from Drexel University in 1976.



Paul Cooper is a Senior Staff Researcher at the Ingersoll-Rand Research Center in Princeton. He is responsible for hydraulic research on turbines and pumps as well as for assisting in the application of this work to the design and performance analysis of these machines. Included is research on cavitation damage in pumps and inducers, erosion in slurry pumps, and hydraulic design approaches needed to improve performance at both design and off design flow conditions. He received a

B.S. in Mechanical Engineering degree in 1957 from Drexel, a M.S. in Mechanical Engineering degree in 1959 from M.I.T. and the Ph.D. in Engineering in 1972 from Case Western Reserve. He is a member of the Executive Committee of the Fluids Engineering Division of the ASME.



Jules L. Dussourd has been at the Ingersoll-Rand Research Center since 1963. He is Assistant Director and Manager of the Fluids/Thermo Department. This group has R & D responsibilities for the behavior of the working fluids in Ingersoll-Rand machinery, including pumps, compressors, engines, power generation and power recovery units, heat transfer and combustion processes, drilling equipment, control systems and

pipng dynamics, etc.

Previously he was involved with gas turbines and aircraft propulsion with the Garrett Corporation and General Dynamics.

He holds a B.S. in Mechanical Engineering degree from CCNY, an M.S. degree in Mechanical Engineering from Columbia University and a Sc.D. from M.I.T.

He is an ASME Fellow and a past chairman of the ASME Fluids Engineering Division.

ABSTRACT

Cavitation surge or the interaction of backflow from the inlet of a centrifugal pump or inducer at low flow and low NPSH can be eliminated by the use of a backflow recirculator. Experimental results from four pumps demonstrate that this device, which has no moving parts, completely stabilized pump operation at all flows from BEP to shut-off.

INTRODUCTION

The pressure pulsations that occur when centrifugal pumps are operated at low suction pressures and flow rates below the design or best efficiency point (BEP) value for a given speed have become more intense as the move toward higher head per stage has progressed in the past two decades. In addition to typical centrifugal pumps, the higher-suction-specific speed designs (including pumps equipped with inducers) that have accompanied this trend have had to be limited in some instances to a narrow range of flow rates centered about the BEP or high suction pressures in order to avoid consequent mechanical damage to pump installations.

This situation has prompted many investigations of the flow conditions in centrifugal pumps, in which gross separated and reversed flow was always found when these unwanted instabilities occurred [1]. This in turn has led to attempts to define the flow rate, fraction of BEP flow rate, at which reverse flow can be expected to occur at impeller exit and inlet (or eye) [2].

The latter backflow at the inlet is characterized by tangential velocities that are of the order of impeller (or inducer) blade inlet tip speed. At sufficiently high values of this inlet tip speed, such backflow is regarded as a cause of pump surge and other instabilities [1].

Backflow at Inlet at Low NPSH

When such a strongly swirling backflow is accompanied by sufficiently low net positive suction head (NPSH), an intense low-frequency pressure-surgeing phenomenon occurs. For centrifugal impellers, Massey [3] reports the frequency of this surging to be from 1 to 6 Hz. He notes that for this to occur, inlet backflow must exist together with the vapor cavities that form in the throats of the blade-to-blade zones of the impeller as NPSH is reduced toward the point of head breakdown. Okamura and Miyashiro also made this connection when they discovered both reverse flow and unstable cavitation by means of flow visualization techniques [4]. Yedidiah provided a brief description of this instability together with a photograph of a core of bubbles extending far upstream of a centrifugal pump operating at a small fraction of BEP flow rate [5]. This cavitation surge phenomenon is accompanied by suction and discharge pressure pulsations. Those at discharge have been found to be as much as an order of magnitude greater than suction pressure pulsations [3].

Nagengast found similar behavior in a hubless inducer [6]. He measured the suction pressure amplitude and dominant surge frequency at flow rates down to 50 percent of that at BEP. At the 50 percent flow conditions, as NPSH was progressively reduced from a high value to that of head breakdown (of both inducer and centrifugal impeller following it), he observed the following: a) smooth, pulsation-free operation; then b), higher-frequency (25 to 30 Hz) relatively low amplitude oscillations; then c), lower-frequency (8 to 25 Hz) oscillations of 6 to 7 psi amplitude, at which very heavy pump and piping vibrations were encountered; and finally d) very low amplitude oscillations near complete head breakdown.

Effect of Pump Design on Inlet Backflow

Surveys of the tangential and axial velocity distributions that characterize backflow at various net flow rates have been

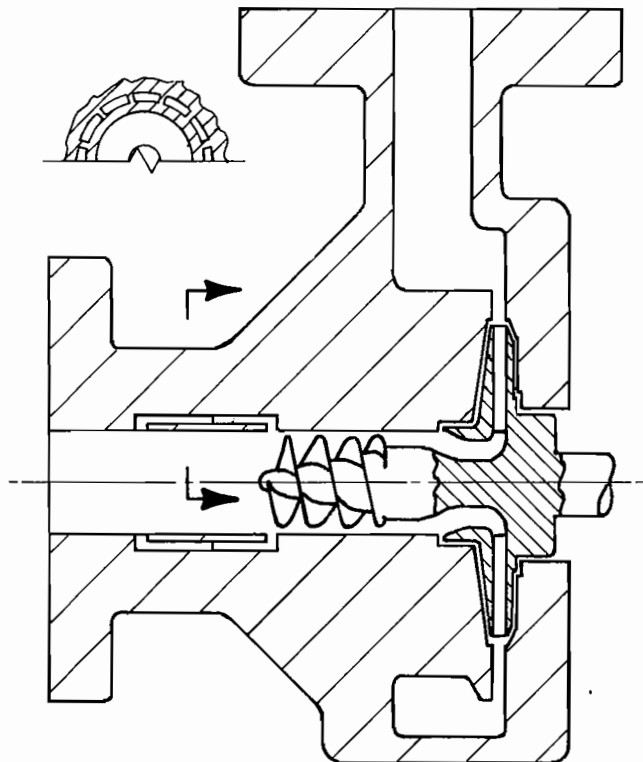

Figure 1. Cross Section of Axial Flow-Backflow Recirculator.

made by Schiavello for centrifugal impellers [7] and Tanaka for axial-flow impellers (similar to inducers) [8]. They clearly delineate the division between incoming and reversed flows that exist at each of several flow rates, Q . At the low inlet tip blade angles (measured from the tangential direction) of high suction specific speed (N_{ss}) impellers and inducers, the "critical flow rate" Q_c at which inlet backflow occurs is much closer to Q_{BEP} .

The practical consequences of this have been the extensive observations by users, who have found generally lower reliability of high- N_{ss} pumps. This has led to recommendations against using such pumps in services with significantly varying flow rates [9]. With their characteristically high- N_{ss} capability, this has led to a strong aversion for inducer-equipped pumps. It can be assumed that these recommendations are coming from users who have experienced cavitation surge. The concurrent requirements of low Q/Q_{BEP} , low NPSH, and strong backflow are not uncommon for these pumps. Also, considerable vibration and the attendant untimely mechanical damage to bearings, seals, wear rings, etc. can be assumed to have occurred in these instances.

Any design feature that inhibits the extent of backflow velocity appears to reduce the flow rate ratio Q/Q_{BEP} at which cavitation surge is observed. In one example presented in this paper, the pump had a large shaft-to-eye radius ratio of 0.6, together with a side inlet. It has been reported that backflow did not penetrate a 90 degree elbow [9]; therefore, for a given design at a given N_{ss} , a pump with a side inlet such as is found on double-suction and multi-stage machines should have less tendency to experience cavitation surge than an end suction pump.

Attempts to Control

Backflow and Cavitation Surge

As cavitation surge occurs at low values of the flow rate relative to zero incidence flow, some designers have purposely reduced the zero incidence flow rate through the use of smaller blade angles and smaller eye radii [4]. However, this obviously restricts the ability of the pump to operate at large flow rates.

Other attempts have been those that are based on the realization that, for any blading design, if the interaction of the swirling backflow with the incoming fluid could be eliminated, cavitation surge would not occur at any flow rate, regardless of suction specific examples of devices which minimize such interaction consists of meridional vanes, to deswirl the backflow, and dams or rings that block the backflow but effectively reduce the eye diameter [10]. These all have a detrimental effect on pump performance near BEP in terms of required NPSE and, usually efficiency.

Devices such as those shown in Figures 1 and 2, which do not have the drawback of degrading performance are introduced in this paper. These backflow recirculators, which are completely out of the mainstream, extract the backflowing fluid, because the high swirl velocity component causes the fluid to move radially into the annular slot. In the arrangement of Figure 1, this fluid then moves axially through a set of straightening vanes, which can also form an axial diffuser, and then back into the mainstream [11]. The version, shown in Figure 2, radially diffuses the flow, then straightens and re-injects it into the mainstream [12].

Elements of the backflow recirculators, shown in Figures 1 and 2, have been successfully tested and are currently available in many commercial pumps, both with and without inducers and with the whole range of possible suction specific speeds. These pumps thereby enjoy smooth, surge-free operation at all flow rates down to shut-off. Furthermore, no ill-effects of these devices on performance have been encountered throughout the entire operating range.

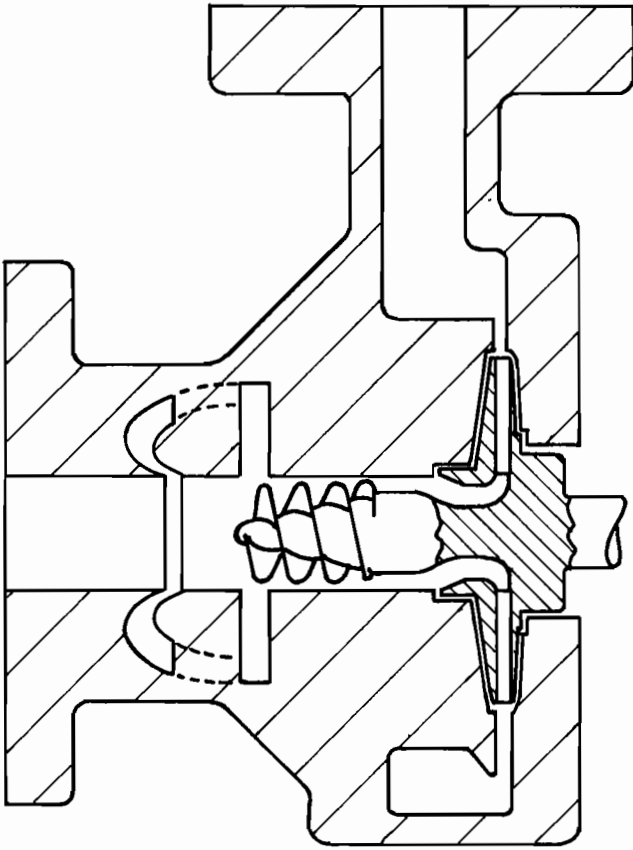

Figure 2. Cross Section of Radial Flow-Backflow Recirculator.

The following sections contain specific cases in which experimental data have proven that the ill-effects of inlet backflow or "inlet recirculation" can be completely eliminated.

THE CAVITATION SURGE PHENOMENON IN PUMPS

Cavitation surge has been widely observed, and efforts to analyze it from a system viewpoint have been conducted [13, 14]. However, in every practical installation there are interactions with all the other components of the pumping systems, and these must be accounted for in any system quantitative analysis. Following is a description of a specific flow phenomenon capable of triggering such instabilities and for which an understanding is needed in order to properly design devices to control it.

Physics of Cavitation Surge

As the pressure in the suction of a pump or an inducer is decreased, the pump behaves quite differently depending upon the flow rate. For a flow rate in the vicinity of, or greater than the design point, the flow pattern is governed by events at the impeller throat. A vapor cavity begins to form near the leading edge and this cavity increases in size as the suction pressure is reduced. The effect on overall pump behavior remains modest until the cavity reaches the impeller throat. The entire throat area then quickly reaches vapor pressure, resulting in the formation of large amounts of vapor there and downstream of the throat, and the pump performance deteriorates rapidly. Finally, a complete breakdown occurs due to choking.

At flows considerably lower than the design point, when the angle of attack becomes large enough, separation occurs,

leading to backflow at the impeller shroud. This backflow has a large tangential velocity component and under its influence the entire flow in the inlet starts swirling. A vortex is created, at the core of which very low pressures can be reached, resulting in a vapor core extending upstream of the inlet. This vapor core then controls the pump suction performance rather than the throat pressure. At intermediate flows, some vapor can form at the centerline without affecting the pump performance to a significant extent. The core may be small in extent and co-exist, or at least not interfere in a major way, with the normal vapor choking off at the throat. A steady mixed-flow regime can thus exist.

The phenomenon investigated herein is that occurring at very low flows as shown in Figure 3 for which the center line pressure falls to a very low value, due to the strong inlet vortex and this effect dominates. As the vapor core develops, it blocks off part of the suction flow area and the through flow tends to be accelerated. Ingestion of part of the vapor further increases the volume flow into the pump. This reduces the angle of attack, which in turn cuts down on the amount of backflow resulting in reduced centrifugal effects. The centerline pressure increases and the vapor core collapses. With this the pump operating condition is returned to its original state for which backflow and recirculation dominate. The inlet vortex forms anew, creating a vapor core at the center and the cycle is repeated all over again.

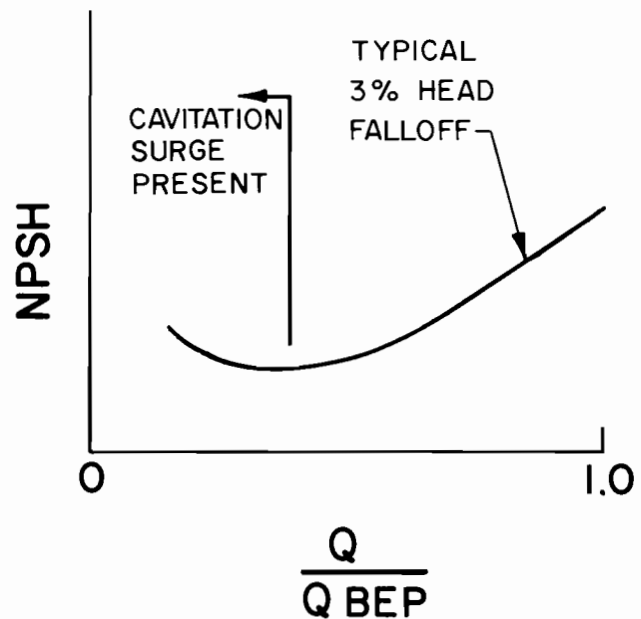

Figure 3. Typical Suction Performance for Pump with Conventional Inlet Configuration.

The amplitude of the individual pressure surges is mainly the result of the changes in the quasi-steady state in the inlet, supplemented by the dynamic effects when piping conditions are such as to promote them. The cycle period is established by the overall system capacitances, the principal one being the vapor core itself. Frequencies are generally low but large pressure excursions can occur.

An analysis of the flow in the suction pipe was carried out in two dimensions for the cases with and without the backflow recirculator or stabilizer. Some of the results, in comparison with data obtained from a small process pump and from the open literature, are presented in Figure 4. While the agreement could be closer, the broad major effects are well simulated.

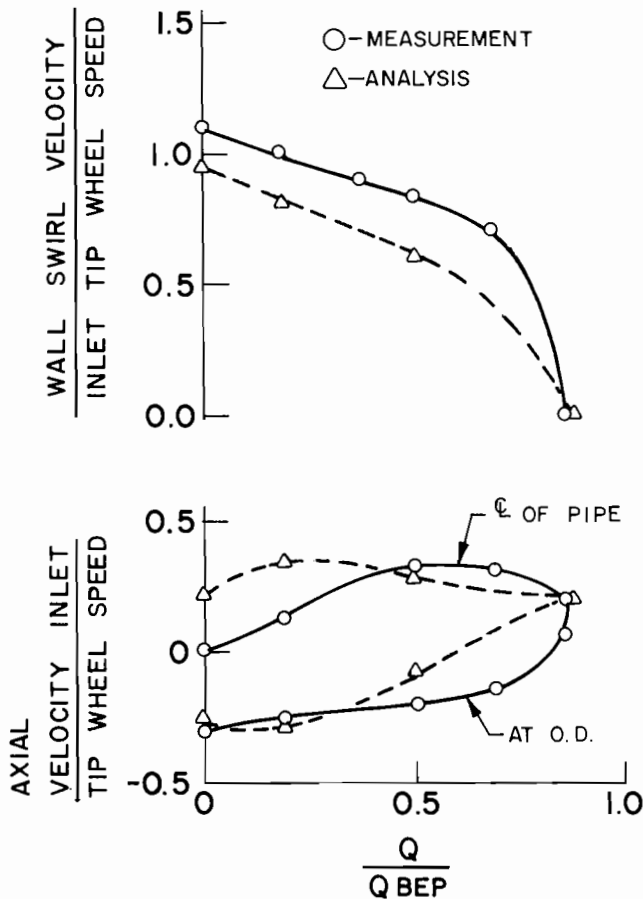

Figure 4. Measured and Calculated Inlet Velocity Profiles.

Effect of Design Suction Specific Speed Capability

From the data that follow and from that already cited from the literature, it is known that impeller and inducer designs which are capable of high suction specific speed, N_{ss} , at the best efficiency point also suffer from cavitation surge over a large fraction of the flow rate (Q) range; i.e., Q_s/Q_{BEP} increases with N_{ss} , where cavitation surge occurs for $0 \leq Q \leq Q_s$. Associated with the higher N_{ss} -values are larger eye diameters and smaller inlet blade angles, and these characteristics have displayed larger values of the flow rate ratio, Q_c/Q_{BEP} , where for $Q \leq Q_c$, backflow exists at inlet (6).

In addition to the presence of the back flow at greater flow rate ratios, the upstream vapor core that is associated with cavitation surge forms more readily in high- N_{ss} machines. In simple terms, the higher the N_{ss} , the lower the NPSH and, therefore, the less extensive the backflow swirl domain has to be to cause vapor to form in the center of the pipe.

Higher Frequency Oscillations

What has just been described is the dominant low frequency surge (≤ 10 Hz) that is characterized by a strong backflow field. The frequency is low because large volumes of vapor must be generated, and it takes time for turbulent momentum exchange to generate the needed generally swirling flow field. Equally, once established, the backflowing fluid inertia must be overcome so that it can decrease sufficiently for the core of bubbles to collapse.

The time constant of such a process would appear to be

quite long in comparison to that which applies to the higher frequency cavitation observed at higher NPSH [6]. Then the bubble volumes are small and probably oscillate in size and position within the impeller blades—the frequency being very likely dictated by the rotating stall characteristics of the machine [15].

EXAMPLES OF BACKFLOW CONTROL

Experience with specific pumps will now be presented that illustrate the cavitation-related instabilities just described. Data are presented for four centrifugal pumps, one equipped with an inducer. Various kinds of backflow recirculators or stabilizers were employed in these examples to remove the instabilities. In all cases the pump and adjacent piping, supports, etc., displayed violent, low-frequency vibration under low-flow low-NPSH conditions-prior to the introduction of the backflow recirculator. Also, the transducers were located as described, in order to monitor pressure pulsations.

Surge Control in a Small Process Pump

Experiments were carried out on a small (400 gpm, 280 ft of head) process pump, designated 3 × 8 AN, using the test apparatus illustrated on Figure 5.

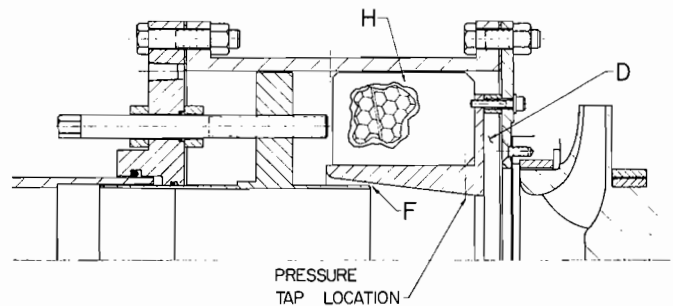

Figure 5. Backflow Recirculator for 3 × 8 AN, Small Process Pump.

This apparatus is a controllable backflow recirculator provided with a generous radial diffusing section D to recover the energy of the swirling backflow extracted from the suction pipe. After diffusing, this flow is lead through an axially oriented honeycomb, H, to remove all residual swirl and then reinjected axially in the direction of the flow, through controllable orifice F. The amount of flow that is extracted from the inlet can thus be controlled. The overall arrangement offers a powerful recirculation effectiveness because of the efficient diffusion achieved in the vaneless radial diffuser.

The experimental backflow recirculator was adapted to the small process pump and data collected over a range of pump flows, suction pressures and for different orifice openings. The results to be described provide an indication of the quantity of flow extraction required to achieve desired levels of surge attenuation.

Pump Basic Performance

The inlet configuration of the pump and the overall performance are shown in Figure 6 and in Figure 7, respectively. Its suction performance (3 percent head fall off) can be seen as the base case (nozzle opening = 0.0) in Figure 8. It has a pronounced and well defined surge behavior at low flows and low NPSH, as typically illustrated in Figure 9. Each individual pulse is accompanied by a distinctly visible vapor plume surging

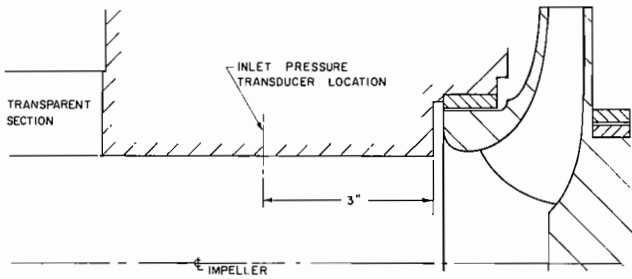

Figure 6. Inlet Configuration of 3 x 8 AN, Small Process Pump with No Backflow Recirculator.

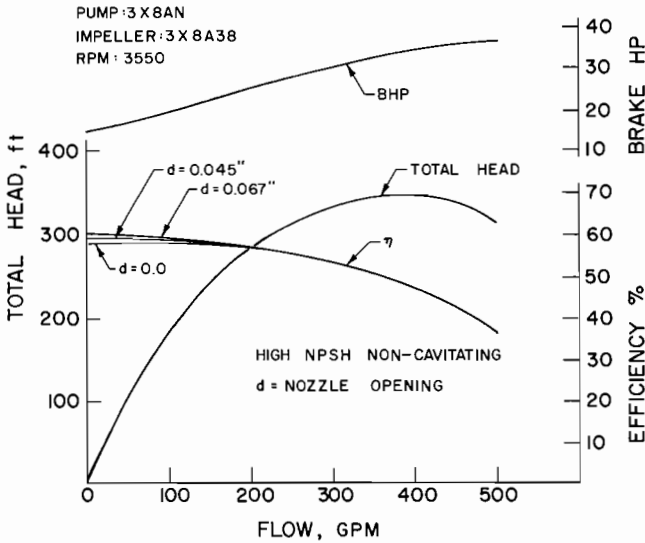

Figure 7. Overall Performance, Small Process Pump, with Various Recirculator Nozzle Openings.

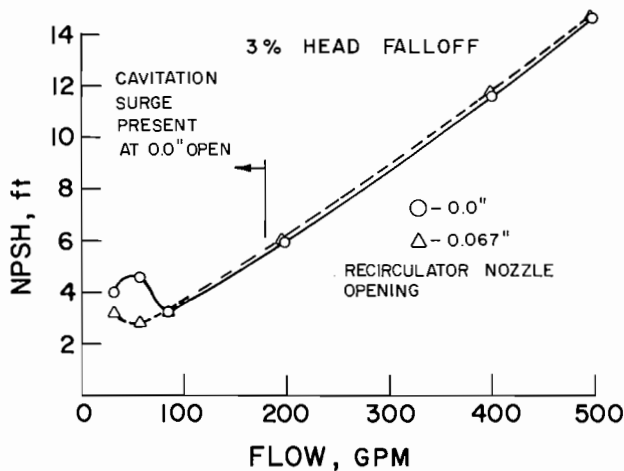

Figure 8. Suction Performance of Small Process Pump with Different Recirculator Nozzle Openings.

rapidly upstream and then collapsing at the surge frequency. The pulse pressure amplitude attenuates rapidly with distance.

These surge amplitudes and frequencies are plotted against suction pressures for different flows in Figures 10 to 13, on which curves labelled $d = 0$, corresponding to the case of zero recirculation flow through the backflow stabilizer. At lower NPSHs, the plume reaches farther upstream and the time of

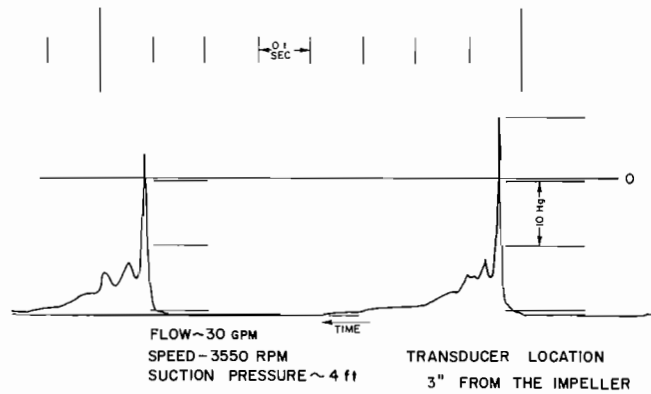

Figure 9. Typical Suction Pressure Trace in Surge for Small Process Pump.

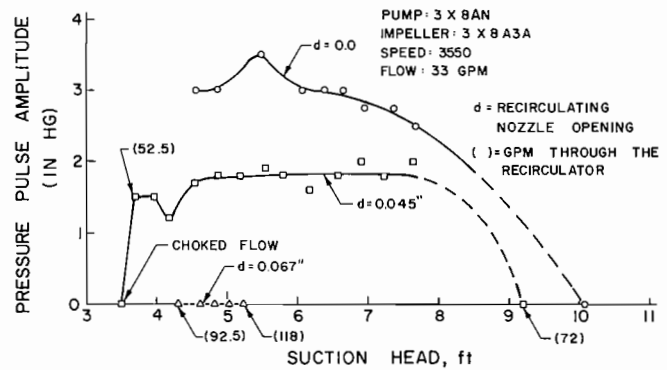

Figure 10a. Small Process Pump Surge at 33 GPM, Pressure Pulse Amplitude.

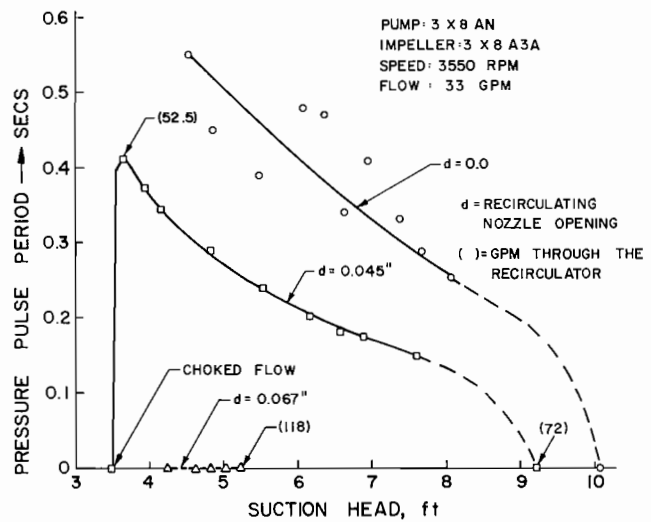

Figure 10b. Small Process Pump Surge at 33 GPM, Pressure Pulse Period.

each cycle increases in duration, but the strength of the pressure pulse generally remains constant. The lower the flow rate, the more severe and the longer the pulse amplitude and period.

Effect of Flow Extraction

Gradual opening of the recirculation flow control orifice rapidly attenuates and eventually eliminates all traces of instability. The recirculatory flow rates for certain operating conditions

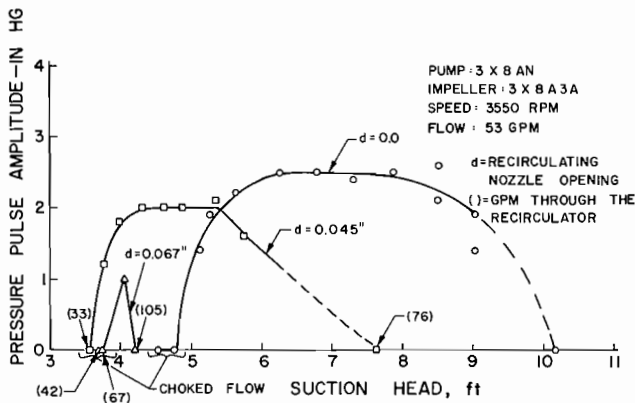

Figure 11a. Small Process Pump Surge at 53.5 GPM, Pressure Pulse Amplitude.

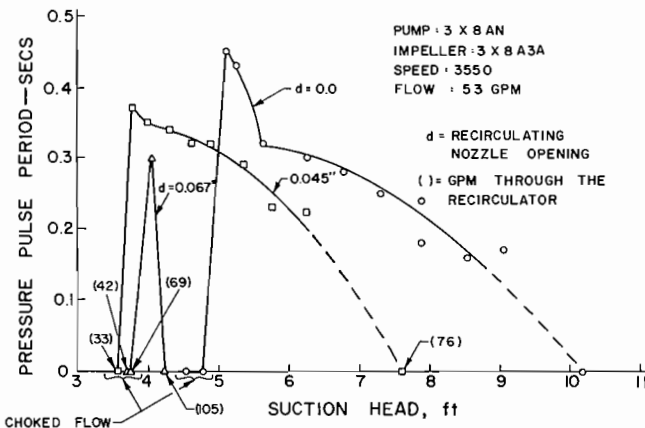

Figure 11b. Small Process Pump Surge at 53.5 GPM, Pressure Pulse Period.

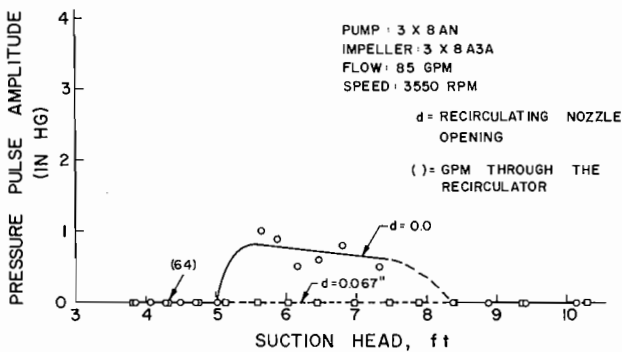

Figure 12a. Small Process Pump Surge at 85 GPM, Pressure Pulse Amplitude.

are indicated in the illustrations. They were calculated using measured orifice pressure drops and orifice flow areas. As pump flow is reduced, the flow through the backflow recirculator must be increased to maintain stability.

The NPSH required to suppress surge, as a function of nozzle orifice opening, is shown in Figure 13. Given sufficient recirculation, it appears theoretically possible to reach the limit of zero NPSHR at zero flow.

The backflow recirculator leaves untouched the basic performance of the pump for head, power and efficiency over the entire flow range, as is presented in Figure 7. This is generally

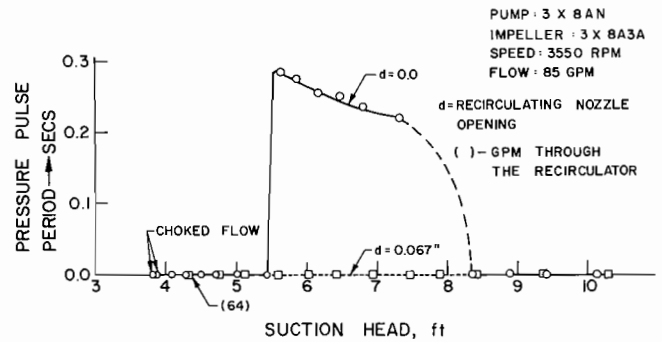

Figure 12b. Small Process Pump Surge at 85 GPM, Pressure Pulse Period.

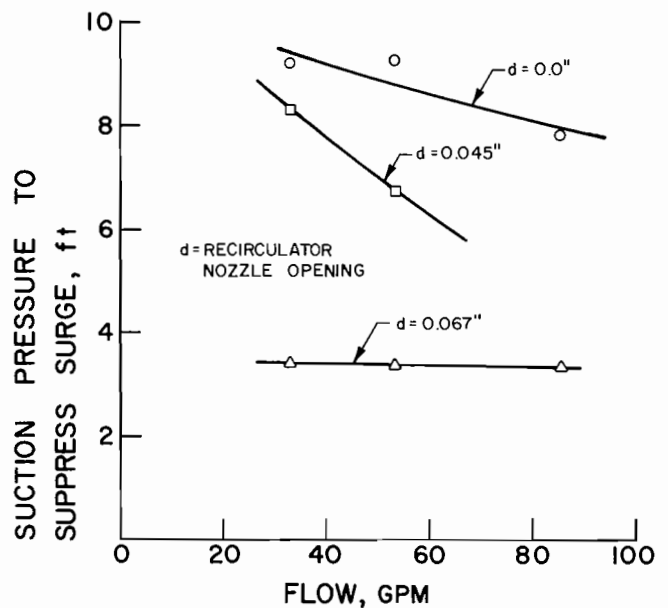

Figure 13. Suction Pressure to Suppress Surge for Various Recirculator Nozzle Openings (Small Process Pump).

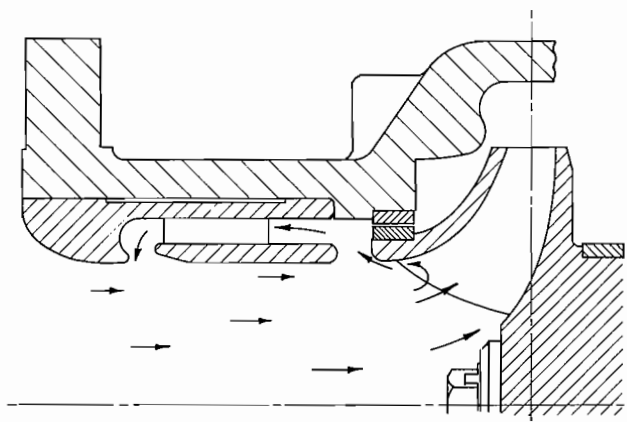

Figure 14. Sectional View of Ingersoll-Rand Process Pump, Model 6 x 10 x 12 ALB, with Backflow Recirculator Insert.

true for the more vigorous backflow recirculator designs for which "efficient" diffusion of the extracted flow is achieved. This is a consideration in the complete elimination of cavitation-related instabilities.

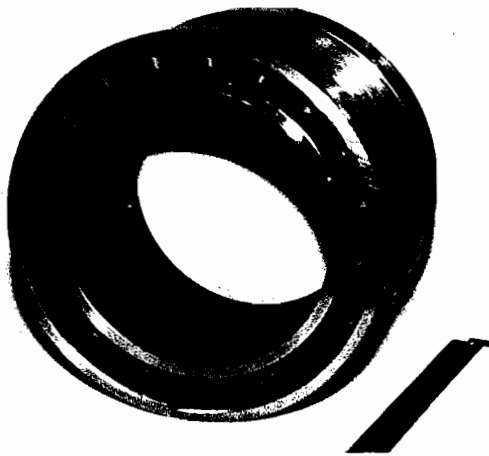

Figure 15. View of Backflow Recirculator Insert as Seen from the Impeller Eye or Downstream End.

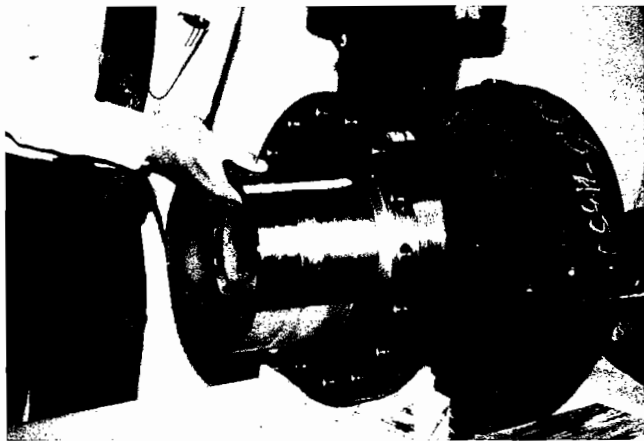

Figure 16. Photograph of the 6 x 10 x 12 ALB Centrifugal Pump Showing the Backflow Recirculator Partially Inserted into the Suction Nozzle.

High Suction Specific Speed Process Pump

An example of a commercial application of a backflow recirculator or stabilizer is a larger process centrifugal pump having the following operating conditions:

Speed:	3570 rpm
Flow Rate:	250 gpm
Head:	590 ft
Specific Speed:	1500
NPSHR 3% Head Loss:	25 ft

These conditions correspond to a 16,000 suction specific speed capability for this pump.

A cross-section of this pump with an axial backflow recirculator inserted into the suction nozzle is shown in Figure 14. The pump was tested both with and without this insert in place. A photograph of the insert, as viewed from the impeller eye, is presented in Figure 15. This element, partially inserted into the pump, is shown in Figure 16. The annulus through which the returning backflow reenters the mainflow passage can be seen in this figure.

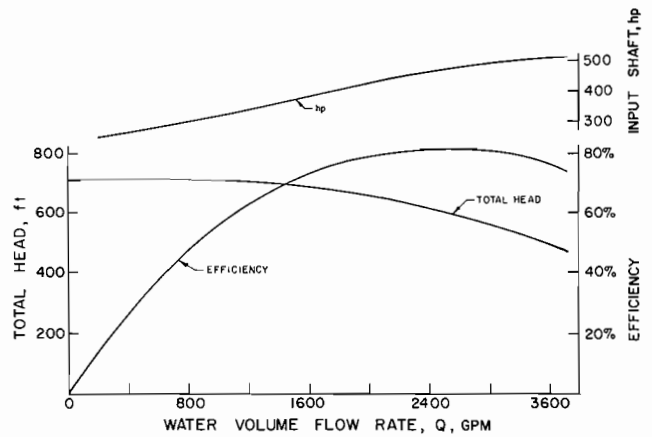

Figure 17. Performance Curves of the 6 x 10 x 12 ALB Centrifugal Pump at 3570 RPM. Results obtained with and without the backflow recirculator differed negligibly.

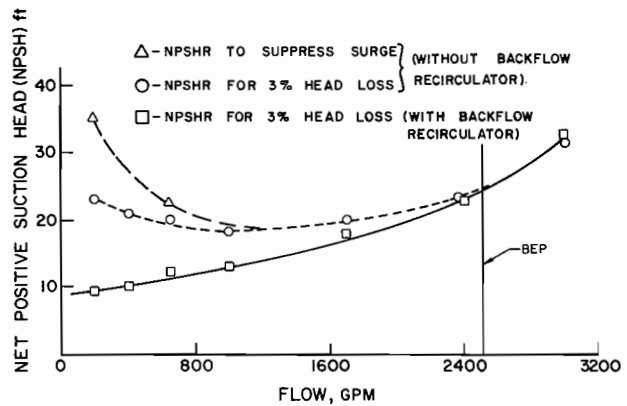

Figure 18. Net Positive Suction Head Requirements for the 6 x 10 x 12 ALB Pump at 3570 RPM. Results are Shown with and without the Benefit of the Backflow Recirculator.

The performance of the pump is displayed in Figure 17. The results were the same with and without the backflow recirculator (BFR), within the ± 1 percent test error in all quantities. For the case of operation without the BFR, Figure 18 shows the NPSH that was required to suppress pulsations as well as that required for 3 percent loss of pump total head. With the BFR in place, this figure shows that not only was the NPSH required to prevent pressure pulsations drastically reduced, but also that this curve is the same as the 3 percent curve.

The frequency analysis of Figure 19a and 19b shows the pulsations sensed by a pressure transducer placed on the suction nozzle near a point where the backflowing fluid enters the BFR. The flow rate was 16 percent of the BEP value. The peak at 3 hz, without the BFR, was accompanied by violent vibrations. With the BFR, the pulsations disappeared and the operation was smooth at all flow rates down to shut off.

Side-Suction Pump with Large Shaft through Eye

Another example of inlet backflow control is a laboratory study of an impeller for a multistage pump. It has a large shaft

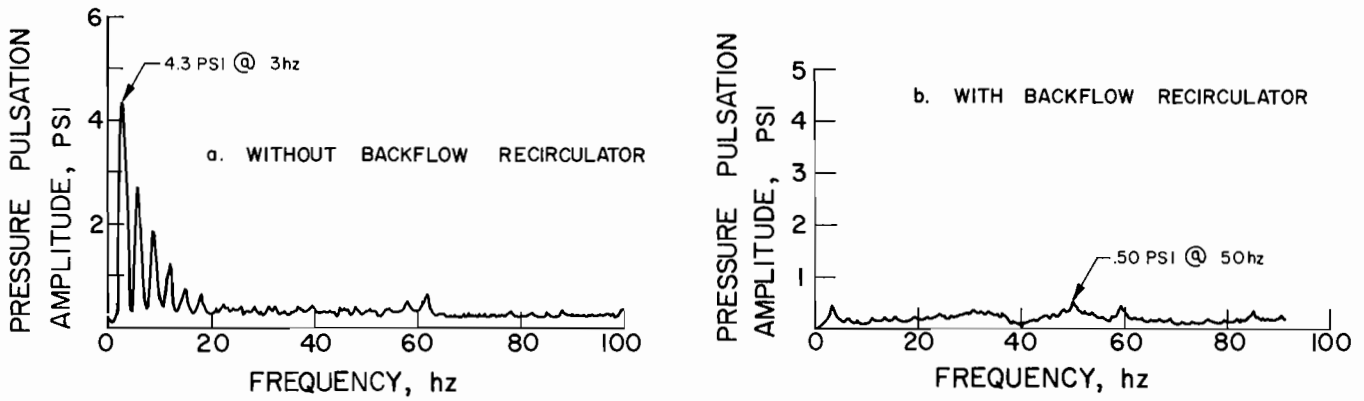

Figure 19 a,b. Inlet Pressure Pulsation Amplitude-Versus-Frequency at 400 GPM (16 Percent of BEP Flow Rate) and 18 Feet NPSH (Near the Head Breakdown Condition).

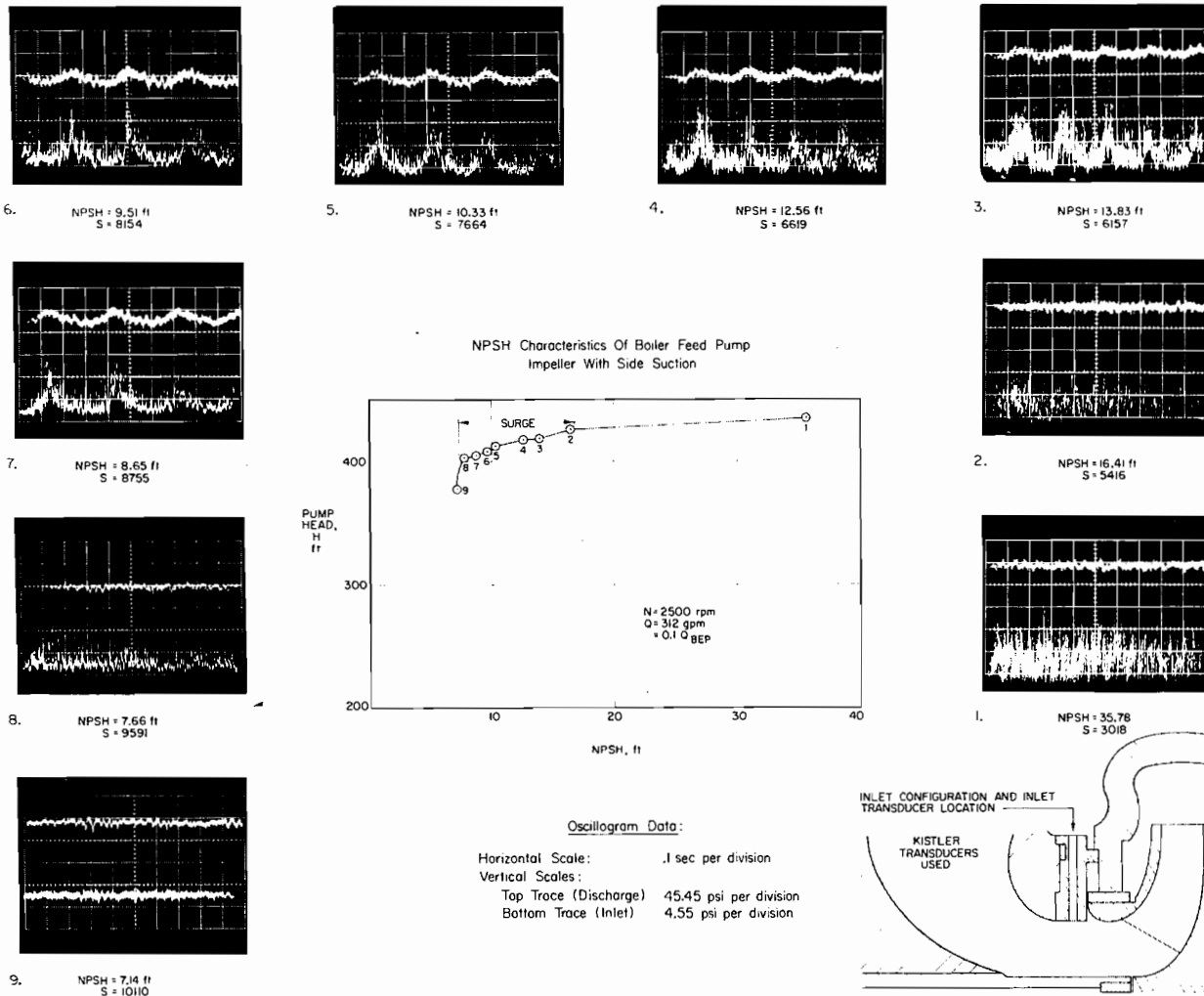

Figure 20. Pressure Pulsation Amplitude-Versus-Time Oscilloscope Traces for Multistage Pump Impeller and Inlet. Each Photograph Corresponds to a Numbered Point on the Head-Versus-NPSH Curve. The Flow Rate Is 10 Percent of That at the Best Efficiency Point.

passing through the eye and was fed by an asymmetric side inlet. The stage had a specific speed of 1700 and an N_{ss} capability of 10,000. The presence of the shaft, which blocked 60 percent of the diameter of the eye, can rightly be viewed as inhibiting the low-pressure vapor core from developing as freely as must be expected with typical end-section pumps such as the one in the preceding example. The side-inlet passage—also in distinction to the uncluttered axial suction approach of the preceding pump—can be expected to inhibit the upstream extent of the backflow field, thereby restricting the exposure for the incoming fluid.

These inhibiting factors indeed were present, because cavitation surge did not develop until the pump was operated at 10 percent of BEP flow rate. The testing was done with the impeller and inlet installed in a single-stage laboratory volute casing.

Pressure pulsation readings taken in the configuration with no backflow control device, (Figure 20), show low frequency surge (4 hz) in the range noted as recorded by pressure

transducers. The lower line of Photo 1 (Figure 20) of this figure shows only a general hash caused by the vigorous backflow from the impeller blade tips of the eye. At the higher NPSH condition shown, the 4 Hz oscillation is absent. This situation is also true at the complete head breakdown condition (Photo 9 in Figure 20), where the backflow-caused hash is essentially absent—the impeller being relatively full of vapor and incapable of creating backflow.

The results with an axial BFR installed are shown in Figure 21. It contained an initial annular section with no vanes to provide mixing and reduction of the swirl velocity component prior to entry into a set of straight, axial vanes. All the low frequency pressure fluctuations were removed. The effect of the BFR on the performance curves was negligible, except that it did cause an increase total head at zero flow rate of about 4 percent. This may have been caused by the reduction of swirl in the inlet pipe, which occurs when stationary vanes are placed near the impeller eye [16].

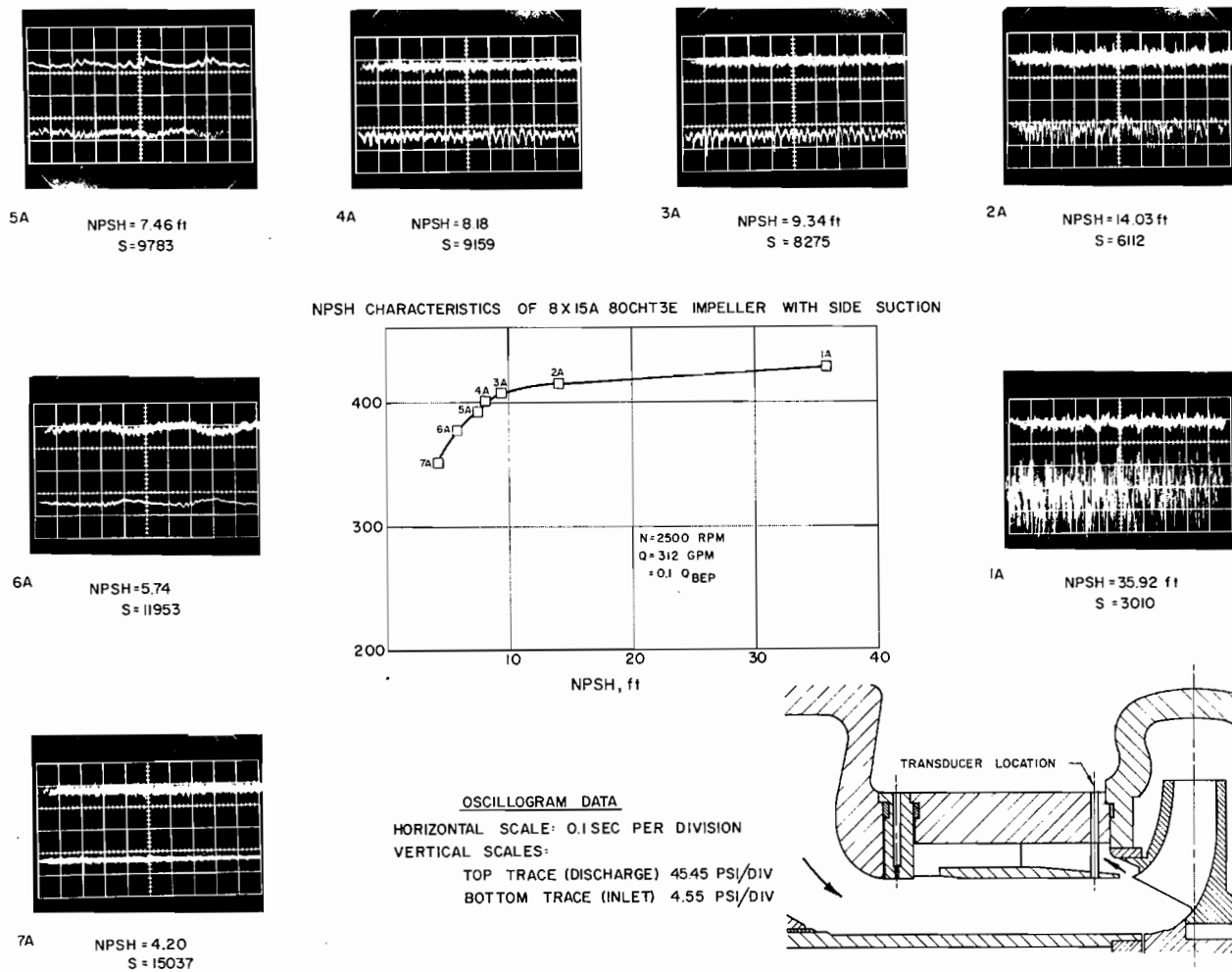

Figure 21. Pressure Pulsation Data for Modified Multistage Pump and Inlet. The Backflow Recirculator, Interposed Between Impeller and Side-Suction Inlet Passage, Removed the Large-Amplitude Low-Frequency Pulsations.

High Speed Inducer Test Pump

In the course of the High Speed Pump (HSP) Development Program, test inducers were designed to be operated in conjunction with an open impeller and concentric collector. A cross-section of the test pump is presented in Figure 22. The performance is given in Figure 23. The inducer provides a suction specific speed of 29,500 at the pump BEP. Suction specific speed of the inducer at its own BEP (95 gpm) is 32,100. At flow less than 60 gpm, cavitation surge was present, and could be detected by sound and feel, using pressure transducers in the inlet or visually through a transparent inlet suction nozzle. The cavitation in the inducer as well as the growth and collapse of the vapor core were clearly visible.

The inlet transient pressure was obtained from a pressure transducer installed 1/2 inch upstream of the inducer leading edge. Plotting the peak to peak pressure pulses at various NPSHs and flows, results in the contour mapping shown in Figure 24. The pressure pulsations (or instabilities) fall into two groupings. At flows less than 60 gpm, visual observations verified the presence of the cavitation surge phenomena. At flows greater than 60 gpm, the pulsations were caused by oscillating cavitation, possibly the result of rotating stall. By oscillating cavitation is meant the periodic axial movement of a band of cavitation bubbles around the O.D. of the inducer, from just upstream to just inside of the leading edge. Oscillating cavitation is undoubtedly a weaker form of the cavitation surge phenomenon, which is incapable of forming a visible core. At these higher flows and at NPSHs greater than those where oscillating cavitation occurred, alternate blade cavitation was observed at the inducer inlet.

Significant forces from the cavitation surge manifested themselves in the form of noise and pipe vibrations. In contrast, the pulsations encountered during rotating stall, while of large peak to peak amplitude, did not cause equivalent distress to the piping or pump. The frequencies encountered during both types of surge are shown on a contour plot in Figure 25. It is remarkable that for a given NPSH, the frequencies remain

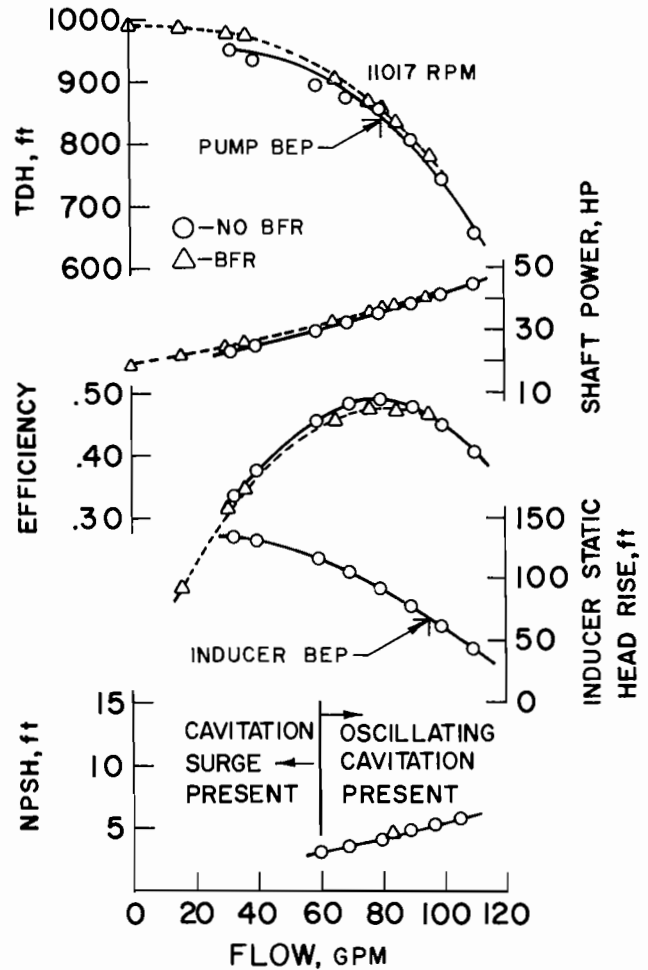

Figure 23. High-Speed Inducer Test Pump Performance.

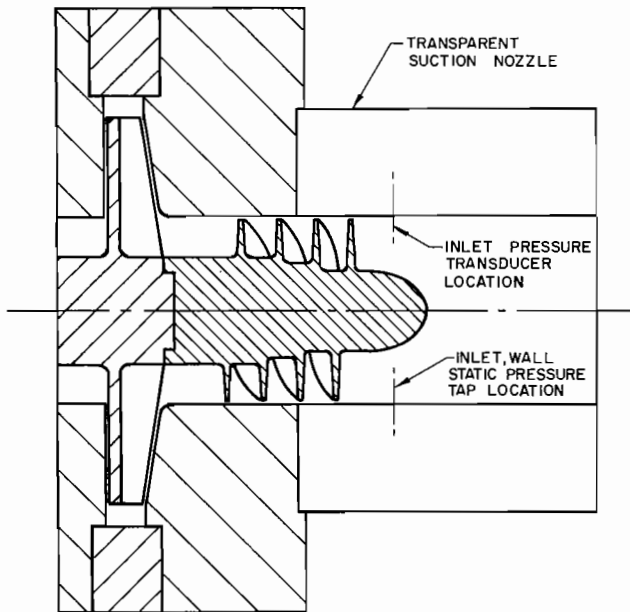

Figure 22. Cross Section of High-Speed Inducer Test Pump.

almost unchanged over the tested flow range.

A high speed inducer, by the very nature of its design (high tip speeds, low blade angle and high suction specific speed), begins to produce high energy backflow at a flow very near its BEP. A plot of the wall static head from two static pressure taps, located 1/2 inch upstream of the inducer leading edge and several feet upstream of the pump suction nozzle is shown in Figure 26. The occurrence of backflow is evidenced by the increase in static head, as measured by the wall static tap just in front of the inducer. The point of incipient backflow occurred at about 85 gpm. This point and its severity varies from one design to another.

In order to intercept the backflow, a backflow recirculator (BFR) was installed on the test pump. The cross-section in Figure 27 shows the test pump with a BFR. This BFR features an annular inlet gap, a radial vaneless space to recover the kinetic energy contained in the backflow, axial straightening vanes and a nearly axial reinjection nozzle. The flow visualization capability of the previous tests was lost due to the installation of the BFR assembly.

Design of BFRs involves optimization of the configuration and physical dimensions of the passages in order to accommodate the amount and intensity of the backflow that could be

encountered with various types of inducers and impellers. It was found that such development was required in this case in order to remove both oscillating cavitation and full cavitation surge at

all flow rates. Measured pressure pulsations with and without an optimized backflow recirculator are shown in Figures 28, 29 and 30. The data were obtained from a pressure transducer which was installed immediately upstream of the BFR inlet gap.

These results were obtained with an optimized BFR which produced a slight increase in pump power consumption as can be seen in Figure 23. This was not always the case for other

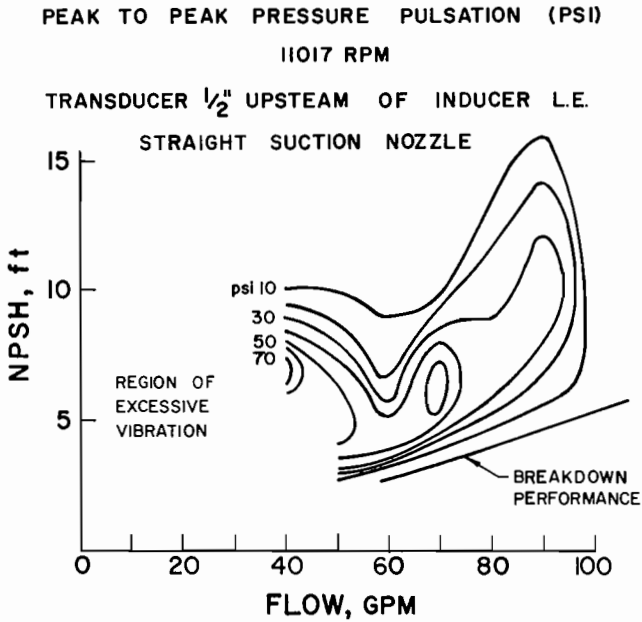

Figure 24. Peak-to-Peak Inlet Pressure Pulsations for Test Pump.

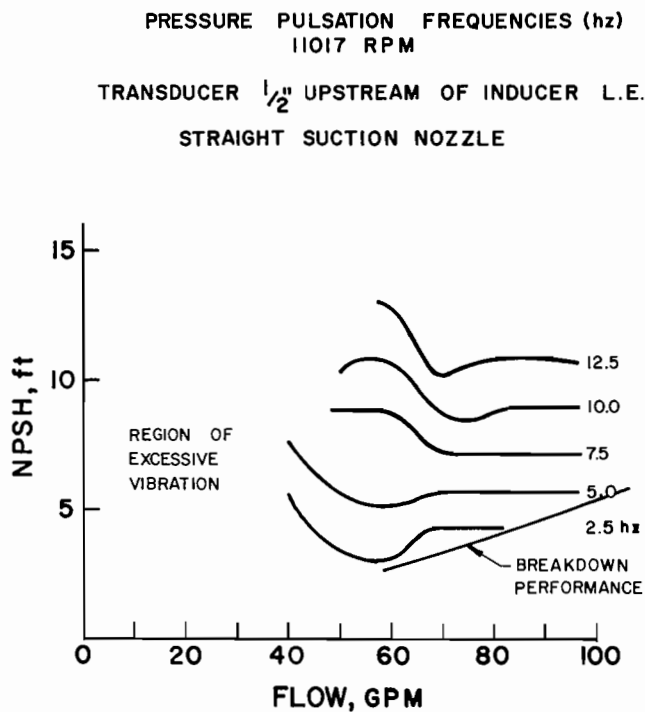

Figure 25. Inlet Pressure Pulsation Frequencies for Test Pump.

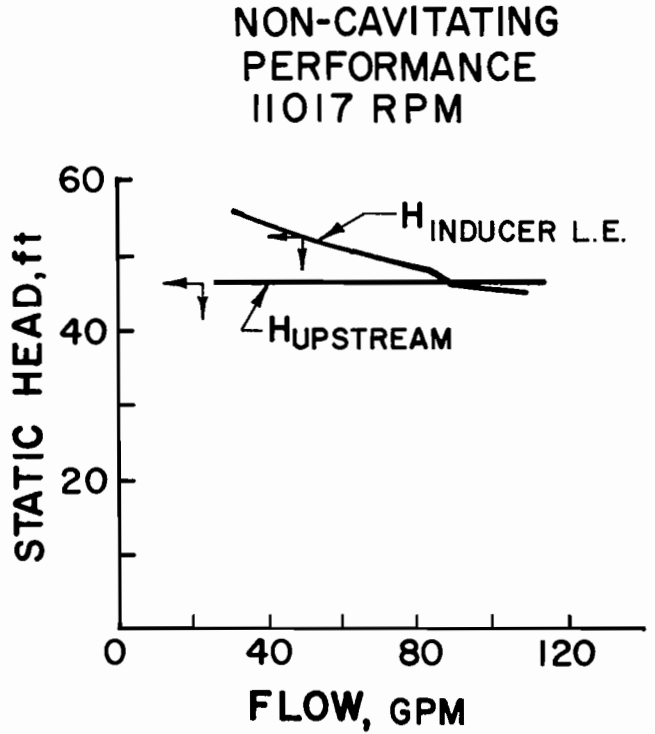

Figure 26. Test Pump Backflow Detection.

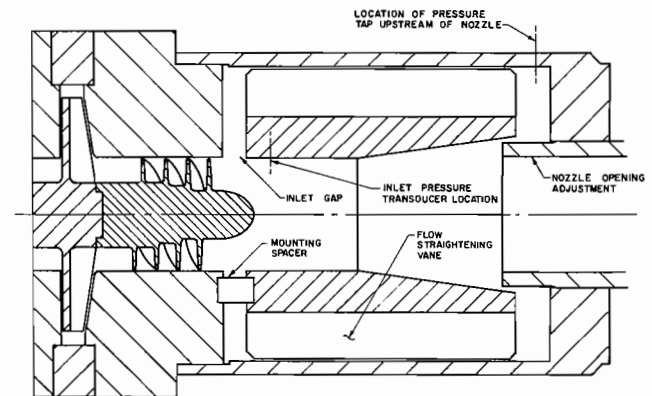
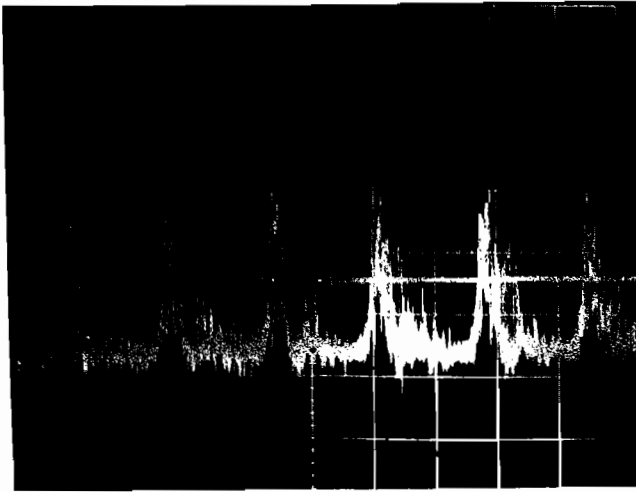

Figure 27. Cross Section of High-Speed Inducer Test Pump with BFR, Configuration.

pump configurations. No change in breakdown NPSH was measured at the pump BEP of 80 gpm. Obtaining NPSH breakdown data at flows less than 60 gpm unfortunately was beyond the evacuation capability of the test facility.



80 GPM 10.6 ft NPSH
 10 PSI / MAJOR DIVISION
 0.05 SEC / MAJOR DIVISION
 NO BACKFLOW RECIRCULATOR

Figure 28a. Inlet Pressure Versus Time for Test Pump, No BFR.

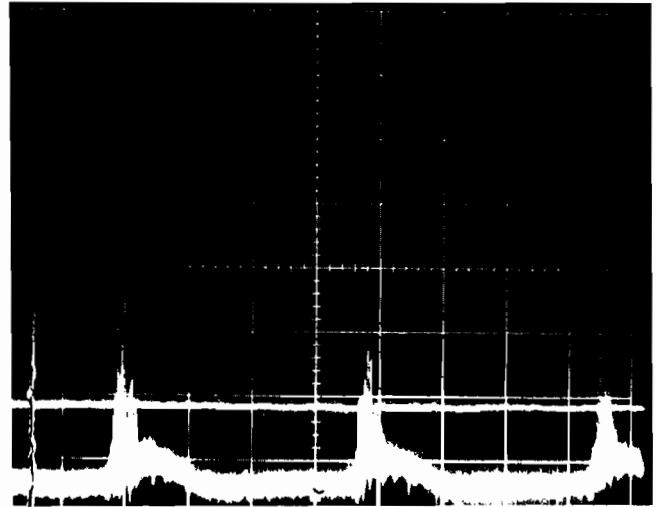

50 GPM 3.7 ft NPSH
 10 PSI / MAJOR DIVISION
 0.10 SEC / MAJOR DIVISION
 NO BACKFLOW RECIRCULATOR

Figure 29a. Inlet Pressure Versus Time for Test Pump with BFR, Configuration. No BFR.

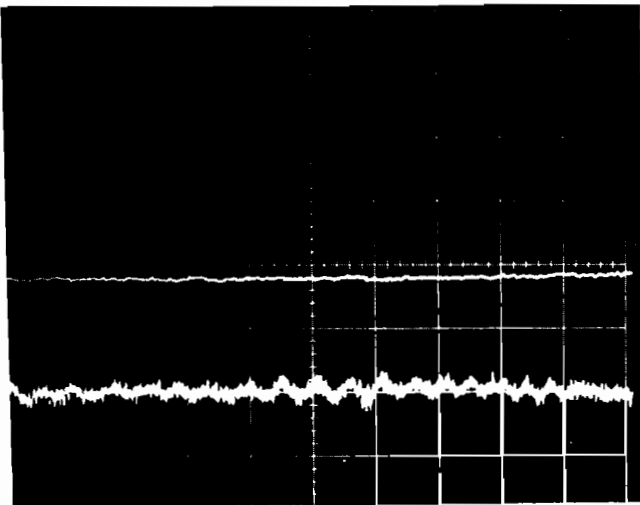

81.5 GPM 10.0 ft NPSH
 5 PSI / MAJOR DIVISION
 0.01 SEC / MAJOR DIVISION
 WITH BACKFLOW RECIRCULATOR

Figure 28b. Inlet Pressure Versus Time for Test Pump with BFR, Configuration.

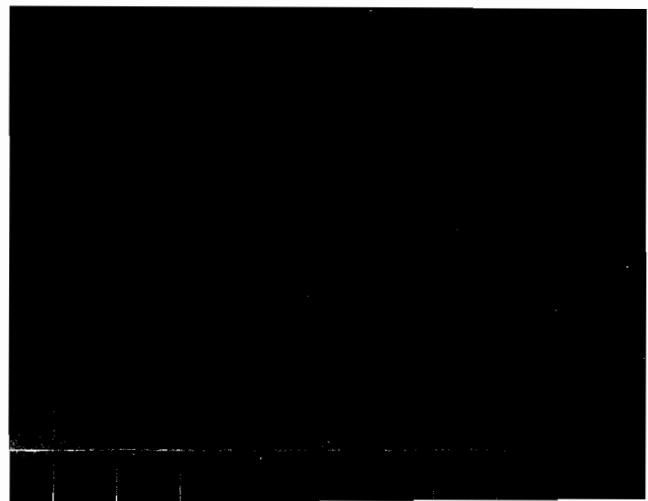

50 GPM 4.2 ft NPSH
 5 PSI / MAJOR DIVISION
 0.05 SEC / MAJOR DIVISION
 WITH BACKFLOW RECIRCULATOR

Figure 29b. Inlet Pressure Versus Time for Test Pump with BFR, Configuration.

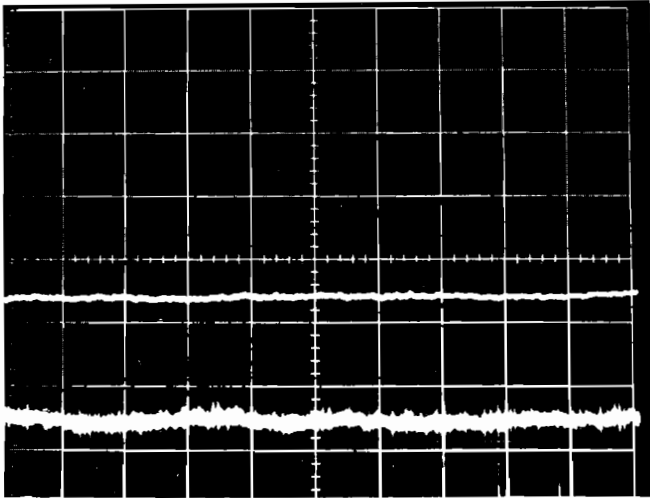

25 GPM 5.7 ft NPSH
 5 PSI / MAJOR DIVISION
 0.01 SEC / MAJOR DIVISION
 WITH BACKFLOW RECIRCULATOR

Figure 30. Inlet Pressure Versus Time for Test Pump with BFR, Configuration.

CONCLUSIONS

When strong backflow from inlets of centrifugal and axial-flow pumps exists at flow rates less than that at BEP, a violent oscillation, known as cavitation surge, can result. This is typically encountered at low NPSH. This type of surge is manifested by low-frequency pressure pulsations at both inlet and discharge of the pump and, intermittent appearance of a core of bubbles extending upstream from the impeller or inducer in the inlet pipe and coinciding with the existence of swirling backflow from the eye. The presence and detrimental effects of this phenomenon are widely reported in the literature. It has also been reported and supported by the data in this paper that backflow and surge tend to occur at flow rates closer to that at BEP in machines of higher suction specific speed (N_{ss}).

Previous solutions to this problem have been one or more of the following: limit the minimum continuous flow rate to appropriately large values; replace high N_{ss} single suction pumps with larger, double suction pumps with a lower N_{ss} per side, if available NPSH cannot be increased; and introduce backflow straightening devices into the pump inlet, most of which block the impeller eye. However, these solutions are attempts to maintain operational stability compromise the desired pump performance.

The use of a backflow recirculator or stabilizer, as described in this paper, is a solution which does provide stable pump operation from BEP to shut-off. This device collects any swirling backflow from the inlet of an impeller or inducer, deswirls it and returns it to the main flow at an upstream point, thereby eliminating the core of bubbles and the cavitation surge. This device a) has no moving parts, b) does not block the inlet, and c) when correctly designed will not adversely affect the head and efficiency over the entire flow range. The NPSH required to maintain head is unaffected at high flow rates and reduced at the lower flow rates.

The backflow recirculator has been tested on several pumps, four of which are reported in this paper; namely, 1) a small end-suction process pump on 11700 N_{ss} , 2) a larger end-

suction process 16000 N_{ss} , 3) a side-suction pump of 10000 N_{ss} and 4) a high- N_{ss} (31000) inducer fed pump. The results of these tests indicate that stable operation is achieved at all NPSH conditions and at flow rates approaching shut-off. This is accomplished with no adverse effect in pump performance in terms of head and efficiency. This stabilizing device has already found application in commercial service on centrifugal pumps of several sizes and speeds, including high suction specific speed inducer-equipped pumps.

REFERENCES

1. Makay, E., "Centrifugal Pump Hydraulic Instability," EPRI CS-1445, Final Report (June 1980).
2. Fraser, W. H., "Recirculation in Centrifugal Pumps," In *Materials of Construction of Fluid Machinery and Their Effect on Design and Performance*, ASME, pp. 65-86 (1981).
3. Massey, I. C., "The Suction Instability Problem in Rotodynamic Pumps," International Conference on Pump and Turbine Design and Development, Paper 4-1. National Engineering Laboratory, East Kilbride, Glasgow, U.K., (1976).
4. Okamura, T., and Miyashiro, H., "Cavitation in Centrifugal Pumps Operating at Low Capacities," In *Polyphase Flow in Turbomachinery*, ASME, pp. 243-251 (1978).
5. Yedidiah, S., "Performance Curves: Key to Centrifugal Pump Selection," *Machine Design*, pp. 117-122 (April 10, 1980).
6. Nagengast, P. "Cavitation Patterns and System Instabilities of a Shrouded Inducer," *1967 Cavitation Forum*, ASME, pp. 28-31 (1967).
7. Schiavello, B., "On the Prediction of the Reverse Flow Onset at the Centrifugal Pump Inlet," In *Performance Prediction of Centrifugal Pumps and Compressors*, ASME, pp. 261-272 (1980).
8. Tanaka, T., "Interconnection Between Efficiency Characteristics and Internal Flow Condition of Turbomachinery," In *Performance Characteristics of Hydraulic Turbines and Pumps*, ASME, pp. 172-178 (1983).
9. Hallam, J. L., "Centrifugal Pumps: Which Suction Specific Speeds are Acceptable," *Hydrocarbon Processing* (April 1982).
10. Breugelmans, F. A. E. and Sen, M., "Prerotation and Fluid Recirculation in the Suction Pipe of Centrifugal Pumps," In *Proceedings of the Eleventh Turbomachinery Symposium*, Texas A&M University, pp. 165-180 (1982).
11. Cooper, P., "Roto-Dynamic Pump with a Backflow Recirculator," U.S. Patent No. 4,375,937, assigned to Ingersoll-Rand., Issued March 8, 1983.
12. Dussourd, J. L., "Roto-Dynamic Pump with a Diffusion Backflow Recirculator," U.S. Patent No. 4,375,938, assigned to Ingersoll-Rand Co., issued March 8, 1983.
13. Greitzer, E. M., "The Stability of Pumping Systems," *Trans. ASME, Journal of Fluids Engineering*, Vol. 103, pp. 193-242 (1981).
14. Brennen, C., and Acosta, A. J., "The Dynamic Transfer Function for a Cavitating Inducer," *Trans. ASME, Journal of Fluids Engineering*, 98, pp. 182-191 (1976).
15. Dussourd, J. L., "An Investigation of Pulsations in the Boiler Feed System of a Central Power Station," *Trans.*

ASME, Journal of Basic Engineering, 90, pp. 607-619 (1968).

16. Kovats, A., "Effects of Non-Rotating Passages on Performance of Centrifugal Pumps and Subsonic Compressors," In *Flow in Primary, Non-Rotating Passages in Turbo-machines*, ASME, pp. 1-14 (1979).

ACKNOWLEDGEMENTS

This work was carried out at the Ingersoll-Rand Research Center in Princeton, New Jersey and at the Ingersoll-Rand Pump Group in Phillipsburg, New Jersey between 1969 and

1983. In addition to the authors, several individuals contributed and in certain instances, directed much of the work; among them, S. K. Singhania, who was responsible for the early experimental work on the small process pump and the late Dr. George Pfannebecker, who was in charge of the high speed pump program at the Princeton Research Center of Ingersoll-Rand. The Phillipsburg tests were directed by C. C. Heald and G. Stem. Thanks is being expressed to the management of Ingersoll-Rand for granting permission for publication, and in particular Mr. Carl Horten, Dr. Wallace McGahan and Mr. W. Schmidt.