

# CONSIDERATIONS FOR PROPER SIZING AND MATERIAL SELECTION TO OPTIMIZE CENTRIFUGAL SLURRY PUMP PERFORMANCE

by

Gary Davidson

Supervisor, Research and Development

Worthington Pump Division—Dresser Canada, Incorporated  
Brantford, Ontario, Canada



*Gary Davidson joined Worthington Pump Division, Dresser Canada, Incorporated in 1980 and is currently Supervisor of Research and Development.*

*He received a Masters' degree in Mechanical Engineering from McMaster University, Hamilton, Ontario, and has done considerable work related to the design and application of slurry pumps.*

*Mr. Davidson is a registered professional engineer in the Province of Ontario.*

## ABSTRACT

Two significant problems are commonly identified when slurry pumps are used in process industries: sizing the pump to satisfactorily suit the service conditions and selecting the appropriate wear resistant materials to provide optimum part life. To the pump user, proper solution of these problems means increased trouble free operation and reduction of related operating costs. Slurry pump sizing and material selection, along with the important benefits to the user of working with the pump manufacturer to achieve optimum pump operation are discussed. These discussions are backed up with laboratory data which clearly illustrate the need to address these concerns fully.

The results are presented for accelerated wear studies done on 4 in × 3 in slurry pumps operated in a silica sand and water slurry. Total wear was measured for the various liquid end components comprised of different materials including hard metal, natural rubber and several polyurethanes. Wear rates for liquid end parts were dramatically different in each case for similar operating conditions. This is because the basic wear mechanisms which predominate in a slurry pump affect these materials in different manners.

The data presented emphasize the need for the user to work together with the pump manufacturer to properly size pumps and select appropriate materials for tough applications.

## INTRODUCTION

Two important aspects which must be carefully considered to optimally operate a centrifugal slurry pump for severely abrasive media transport are correctly matching the pump to the hydraulic system, and selecting liquid end materials which will maximize pump longevity.

The objectives of optimizing slurry pump performance are:

- to prevent the rapid deterioration of liquid end components due to abrasive wear which may markedly curtail useful pump life, thereby increasing process costs.
- maintain high pump efficiency for the prescribed condition of service, thereby minimizing energy consumption and reducing the incidence of mechanical failures due to high radial and thrust loads on shafts, bearings, etc., which occur as a result of operating at off design capacities.

Although wear cannot be prevented, a fundamental understanding of the abrasive nature of the slurry being pumped and selection of a properly designed liquid end are important considerations for satisfactory pump performance.

As discussed later, slurry pumps have historically been oversized for the intended applications and operate at capacities well below the best efficiency point (BEP). The result of this is increased internal recirculation which manifests itself as frictional losses. The deleterious effects of recirculation for pumps handling particle free Newtonian fluids such as water are just now being more fully understood [1]. There are however, additional detrimental effects of recirculation when a slurry is being handled. These are in the form of increased wear in the zones of high recirculation due to the ensuing acceleration of solid particles.

It is also essential to select liquid end materials which have the necessary properties of hardness, toughness and resilience to resist high rates of erosion as dictated by the individual application. The importance of proper material selection cannot be treated lightly. Part life can range from a matter of weeks to many months, depending on subtle differences in material properties.

Proper pump sizing and material selection for any slurry pump application cannot be overemphasized. It is the responsibility of the pump manufacturer to attain the best hydraulic design for maintaining high pump efficiency while minimizing slurry recirculation and other factors which increase particle impact velocities and accelerate pump wear. It is important for the user and the manufacturer to work together to properly resolve tough applications. In many cases, this may include trial and test studies or reduced scale laboratory testing, to determine the effects of slurry rheology and abrasiveness on slurry pump performance and wear rates. This can lead to tremendous savings in full scale operation costs.

The aspects of pump sizing and material selection are examined, since these pertain to optimizing pump performance. Pump wear data are presented to illustrate the effect of operating slurry pumps at partial capacities. Recirculation at reduced capacities is discussed as it relates to premature failure of liquid end components. Finally, data are presented which establish the wear rates of different materials in the same slurry application to demonstrate the impact these considerations have on successful pump operation.

## WEAR IN SLURRY PUMPS

Wear due to solid particle abrasion is the greatest single aspect that distinguishes the design and application of slurry pumps from conventional centrifugal pumps. Wear is a very complicated phenomenon which depends on many parameters intrinsic to both the pump and the slurry being handled. It arises as the result of localized material removal due to the impingement of solid particles.

The mechanics of wear have been studied both theoretically and experimentally, yet are still not completely understood nor easily modelled as they relate to slurry pumps. Finnie [2] compared theoretical analyses of wear with experimental results in which particle velocity and impingement angle were varied. Good agreement was obtained for tests done on ductile specimens for small impingement angles. Bitter [3] also presented a fundamental study of erosion phenomena but extended his theoretical model to account for impingement normal to the surface of the test specimen. This so-called "deformation wear," is associated with the repeated bombardment of the wearing surface which eventually causes cracking and spalling of the material. Bitter provides expressions for cutting and deformation wear based on energy considerations and material properties—brittle or ductile. Neilson and Gilchrist [4] present experimental results for the erosive action of solid particles on test specimens with a variety of physical properties. The purpose of the work was to simplify the theoretical analysis of the problem and correlate the derived relationships with the experimental results. A summary of the nature of abrasive wear in hydraulic machinery is presented by Truscott [5].

It is somewhat doubtful as to whether these complex theories can be used to accurately predict absolute wear rates

in slurry pumps with any certainty. Most are dependent on empirical indices which are readily assessed under controlled laboratory conditions, but are not easily determined in rotating machinery. It is difficult to correlate jet abrasion test data with pump wear rates, since conditions in the pump vary with time. Particle velocity and angle of impingement change continuously as the pump wears.

Essentially three abrasive wear mechanisms predominate in a slurry pump and cumulatively determine wear rates.

*Deformation Wear*—which is the result of sustained high velocity directional impact on the solid boundary, due to the normal component of the particle velocity vector. Wear occurs when impact stresses exceed the local yield stress of the boundary material and deform it. Strain hardening occurs due to repeated plastic deformation from high angle, high energy impact and leads to cracking of the surface layer and subsequent material removal (Figure 1 (a)). Penetration of elastomeric materials occurs when particle energy is sufficient to permanently tear the surface.

*Erosive Wear*—occurs when the local shear stress of the material is exceeded and a fragment of the material is broken loose. This is due to low angle impingement and is associated with the velocity component of the particle which is parallel to the surface of the boundary (Figure 1 (b)). Cutting, or gouging wear, occurs when sharp particles have sufficient energy to shear pieces from a ductile material and typically leave the surface grooved. Ploughing occurs as the result of impact of rounded particles which displace material to the edge of the groove. Brittle materials fail as a result of crack formation and subsequent cleavage of particles from the surface. Sliding, or scouring wear is the result of low stress packed slurry erosion which has a lapping or polishing effect on the surface.

*Grinding Wear*—is encountered when solid particles become entrapped between surfaces moving relative to each other in close proximity. Concentrated compressive and shear stresses transmitted between the three bodies, due to crushing forces on the particle, cause localized ductile or brittle failure. Fragmentation of the particle will cause further erosive wear due to scouring at very low impingement angles (Figure 1 (c)).

The wear rate is dependent upon three closely inter-related factors:

- the slurry characteristics which include properties of the particle phase (hardness, size, shape, density), the liquid phase (corrosiveness, viscosity, specific gravity), and the overall rheological properties which depend upon these and other factors (such as critical settling velocity and concentration).
- materials used in the construction of the pump (hardness, resilience, tensile strength, ductility, fatigue characteristics).
- the nature of the contact phase (velocity and impingement angle) which is influenced by the hydraulic design and pump selection.

Wear rates vary from point to point in a pump, as a function of geometry and the predominating wear mechanism. Abrasive wear and the effect of particle laden fluids on slurry pump performance have been discussed elsewhere [6, 7, 8, 9, 10, 11, 12]. Progress is being made to assimilate wear characteristics in a comprehensive manner. Experimental studies [7, 9, 11,] indicate that component failure generally occurs first in zones where cutting wear predominates. This is due to immediate failure of the material on impact, rather than fatigue or spalling which has a time-intensity component associated with it. Wear is

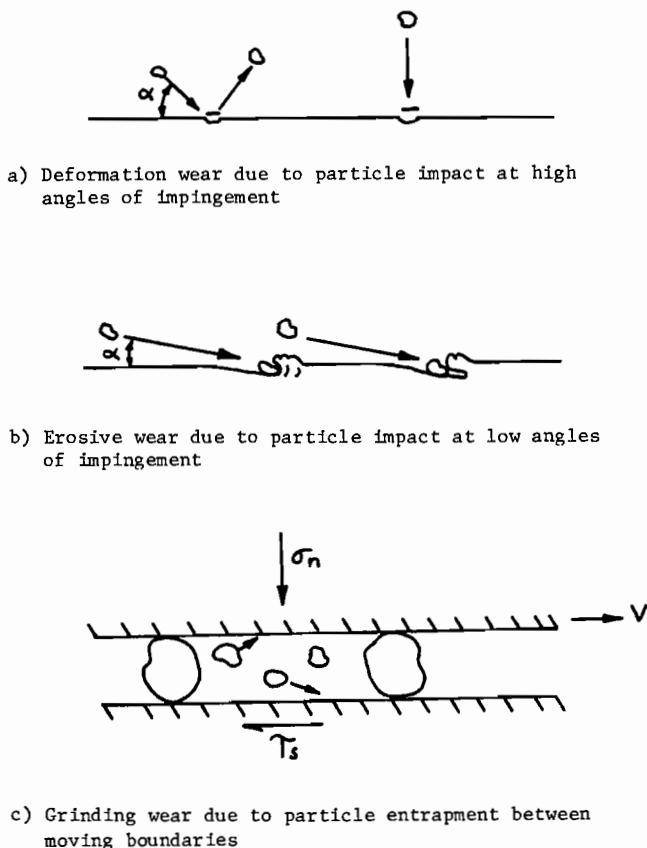
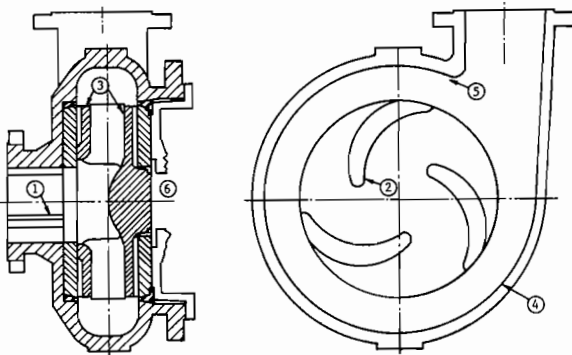

Figure 1. Basic Wear Mechanisms in Slurry Pumps.

accentuated when the pump is operated at partial capacities, because mean fluid flow paths no longer coincide with the hydraulic contours of the pump as they do at the design point, and because local velocities are increased due to greater internal recirculation.

Cutting wear occurs at the volute wall as the mixture is directed to the discharge nozzle under the influence of centrifugal and Coriolis effects. Because of streamline curvature, the particles are directed toward the boundary. Particle impingement leads to ploughing and shearing which give rise to a scalloped wear pattern. This is associated with a loss of kinetic energy downstream of the point of impact and a subsequent increase in kinetic energy when the particle tumbles back into the mainstream. The mechanics are very similar to the lapping action of waves that leave a rippled surface on a beach as they recede.

Cutting wear also occurs at impeller shroud tips and vane tips due to the relative velocity of the impeller periphery to the slurry in the volute (Figure 2). The relative velocity increases when the pump is throttled to reduced capacities and causes additional wear on wear plates. As a general rule, impeller tip velocity should not exceed 100 surface feet per second to prevent excess wear in dense media service.



- ① SUCTION NOZZLE -low angle erosive wear due to prerotation of mixture which may be reinforced by recirculation.
- ② IMPELLER VANE TIP -primarily erosive wear due to cutting and sliding abrasion. Some deformation wear due to high angle impact at leading edge.
- ③ IMPELLER SHROUDS AND WEAR PLATES -maximum wear at impeller outer diameter where velocities are greatest. Grinding abrasion between faces due to recirculation of slurry - primarily suction side.
- ④ CASING VOLUTE -erosive wear due to cutting and gouging of high velocity particles.
- ⑤ CUTWATER -gouging due to recirculating streams passing cutwater. Some deformation wear due to high angle impingement at cutwater.
- ⑥ SHAFT SLEEVE -grinding wear due to particle ingestion into soft packing.

Figure 2. Critical Wear Points in a Centrifugal Slurry Pump.

Low angle erosive wear at the suction nozzle occurs due to the presence of prerotation, which may be amplified by merging recirculating fluid streams. Anti-prerotation vanes cast into the suction nozzle are a desirable design feature to disrupt sustained particle impact at high velocity. Additionally, the cutwater area is prone to cutting and gouging wear as recirculating fluid streams redirect particles and accelerate them towards solid boundaries.

Grinding abrasion occurs primarily between impeller shrouds and wear plates, where clearances may be smaller than the solid particle diameter. It is important to maintain proper impeller axial clearance to prevent particles from ingressing into these areas. If particles are very tough and dense, it may be advantageous to increase the clearance

beyond the mean particle diameter to prevent binding of the impeller. Scouring type wear may accompany grinding as the solids fragment. Smaller particles, or a compacted layer of particles are dragged along the wear plate by the mainstream flow causing less severe pitting and scarring.

Deformation wear is generally not a prevailing factor in slurry pumps, since particle impingement angles are kept low as a result of the hydraulic design. The normal component of the particle velocity vector is, therefore, not that great, and erosive wear tends to predominate. Impact angles are normally less than 20 degrees at BEP but may increase to 30 or 40 degrees at off capacities. High angle impact may occur at the cutwater, since slurry streams are directed towards the discharge nozzle causing localized deformation wear.

### ABRASION RESISTANT MATERIALS

Materials used for wear resistance in slurry pumps include: hard metals, elastomers and more recently, ceramics. Each type of material has different wear characteristics, and it is normally the case that one is better suited for a given application. Once the type of material required is determined, some specific properties may require further modification to optimize part life (e.g., hard rubber versus soft rubber). In many instances the wrong material is selected based on a perceived capital savings and must be changed at a later date due to poor performance. Total return on investment and not initial cost should be the economic criterion for choosing wear resistant materials.

#### Hard Metals

Hard metals are used in most mining and ore processing applications where the slurry particles are coarse, hard and sharp. As a general rule, the hardness of the alloy will determine its resistance to particle impingement. Materials with high shear and compressive strengths are required, depending upon the kinetic energy possessed by the particle at impact. Ferrous metals are usually selected over non ferrous metals because of their greater toughness. Martensitic white irons such as 15/3 alloy (15 percent chrome, three percent molybdenum), Ni-hard (four percent nickel, two percent chrome with increased carbon content for greater toughness) and high chrome white cast irons are typically used (Table 1). These materials are very hard in both the as cast and heat treated conditions (500-700 Brinell hardness) and have excellent resistance to low angle cutting wear.

Table 1. Material Properties of Hard Metals Used in Slurry Pumps.

Composition (Per Cent)	Ni-Hard 1	Ni-Hard 4	High Chrome Iron	15/3 Alloy
Total Carbon	2.7-3.2	2.8-3.2	2.8-3.2	3.0-3.6
Silicon	0.3-0.8	1.5-2.2	1.0 max.	1.0 max.
Manganese	0.2-0.3	0.2-0.8	0.1-1.5	0.1-1.5
Sulphur	0.15 max.	0.15 max.	0.06 max.	0.06 max.
Phosphorus	0.3 max.	0.3 max.	0.10 max.	0.10 max.
Nickel	3.0-5.5	4.0-6.0	1.0 max.	1.0 max.
Chromium	1.5-2.5	8.0-10.0	22.0-28.0	14.0-17.0
Molybdenum	0.5 max.	0.5 max.	1.5 max.	1.0-3.0
Indicated Brinell Hardness Range	500-600	500-600	600-650	650-730
Tensile Strength (Tons Per Sq. Inch)	18-22	30-35	30-35	30-35

Ni-hard (grades 1 and 4) and high chrome iron are the most popular metal alloys for coarse slurry pump applications. Ni-hard is very resistant to sharp abrasives (cutting

wear), but tends to be brittle and prone to high angle deformation wear. It is generally not used in dredge pumps where solid particle sizes are considerably greater. Ni-hard 4 is often used in high head applications where more ductility is required.

High chrome iron is normally chosen for severely abrasive applications, especially where superior corrosion resistance is required. A microstructure consisting of hard chromium carbides imbedded in an austenite matrix is possible through careful alloying. While the chromium carbides offer excellent resistance to slurry abrasion, the austenite matrix offers maximum protection against chemical attack. If optimal abrasion resistance is desired, full heat treatment is suggested to produce a martensitic matrix, which is both harder and stronger than the austenite. The success of high chrome irons over the nickel-chrome irons can be rationalized by considering the hardness of chromium carbides (1500-1700 Brinell hardness) compared with iron carbide (800-1100 Brinell hardness) [13]. The harder carbides make a significant contribution to the overall wear resistance of the material, especially against impingement from larger particles which must impact the chromium carbides rather than erode the surrounding matrix. The heat treated matrix provides greater mechanical support for the hard carbides. Heat treated high chrome impellers can outperform Ni-hard in comparable services 2:1 or 3:1, thereby reducing parts and maintenance costs.

#### Elastomers

*Rubbers*—This category of wear resistant elastomers includes natural gum rubber and synthetic rubbers such as neoprene, hypalon and nitrile.

Natural rubber is the most common non-metallic wear resistant material used in slurry pumps. It will provide better wear resistance than metals or other elastomers for specific particle classifications (0.01 inch or finer) and velocities, provided it is compatible with the carrier medium. However, natural gum rubber is expensive and very soft (poor structural qualities for impellers) and is, therefore, modified with carbon black fillers to obtain the desirable characteristic of higher tensile strength.

Rubber has excellent resilience (deformation-recovery characteristics), which makes it preferable for slurries consisting of finer solid particles generally not in excess of 0.15 in diameter. The kinetic energy of the particle will not exceed the deformation characteristics of the rubber. Rubber absorbs the load due to its elasticity (ability to store energy while stretching 700 percent to 800 percent without rupturing and recover to its original shape), as distinguished from a non-elastic material where the kinetic energy at impact causes plastic deformation.

Rubbers do not possess high shear strength, and consequently they tend to tear if the impinging particles strike at shallow angles with high velocity (Figure 3). Sufficient material thickness must be provided in order to prevent penetration of the rubber at high impact angles. If the impact energy is great (particle size, specific gravity, and velocity) relative to the rubber thickness and the compression is sufficient, the rubber may be permanently torn. Therefore, appropriate rubber thickness must be provided to absorb impact energy and increased an adequate amount for wear allowance.

Optimal rubber hardness for slurry pump applications is 35 to 40 Shore A durometer hardness. However, this low hardness places definite speed constraints on the impeller which can only be relaxed by increasing rubber hardness at the expense of abrasion resistance. Natural rubber has poor

tear and cut resistance. Sharp particles or tramp material (wire, metal, etc.) can cause severe damage. Natural rubber also has limited resistance in hydrocarbon fluids (e.g., oil and solvents). The useful temperature limitation is 150°F. Other elastomeric materials may be selected depending on the chemical and temperature resistance required. These include:

- Neoprene which is not as good as natural rubber in terms of abrasion resistance but may be cost effective in the presence of oils and many chemicals. It is less likely to absorb chemicals and has an application limit of 200°F.
- Nitrile is used where oil is a major constituent of the carrier fluid. It also has good abrasion resistance in chemicals other than hydrocarbons and can be used up to 200°F.
- Hypalon is more resistant to strong acids and oxidizing chemicals up to 225°F. Abrasion resistance in oils is comparable to neoprene.

*Polyurethanes*—Polyurethane elastomers are gaining increasing popularity over conventional rubber elastomers in slurry pump applications which are both highly abrasive and corrosive. Urethanes are either polyether or polyester base segmented block copolymers. The polyether or polyester makes up the flexible segment of the elastomer which binds the stiffer blocks together through molecular cross linking. The difference between polyurethane and rubber is that where strength is inversely related to hardness in conventional rubber, the opposite is true for urethane. The chemical structure of urethane can be engineered to maximize either resilience or toughness by altering the level of cross linking. Polyesters generally offer greater durability and toughness than polyethers for a fixed material hardness.

Polyurethanes bridge the gap between rubber and plastics in terms of hardness (typically ranging from 20 Shore A durometer to 85 Shore D durometer). Urethanes have both high tensile stress properties as well as high elongation for toughness and durability. Plastics are relatively strong, but lack extensibility; rubbers are highly extensible but lack strength. Polyurethanes can combine strength and extensibility to provide excellent resistance to abrasion, impact and tearing. Additionally, they have superior hydrolytic stability and are exceptionally resistant to oils and hydrocarbon solvents. Neoprene which offers excellent oil resistance, has inferior tear and abrasion characteristics.

Urethanes perform best in wet slurry applications where the particle size is 0.3 in or less, and the wear mechanism is due to low angle abrasion. Urethane lined slurry pumps are applied in floatation and preparation plants on classifier service, and at the tailings disposal end of the mill. Urethanes retain superior abrasion resistance in water slurry immersion at temperatures up to 150°F for a pH range from 2 to 12. In some applications, the liners are fabricated from an ester base material for toughness, to resist sliding abrasion, and the impeller is an ether base, for greater resistance to higher angle particle impingement. Hardness of the material generally ranges from 70 to 85 Shore A durometer.

The purchase cost of urethane is much greater than for other elastomers, but because it can be cast in open molds at room temperature, the manufacturing cost may be comparable. Wear life must provide the economic justification. In addition, the structural integrity of urethane reduces the amount of steel support required and increases the operating speed range of a pump beyond the limits of rubbers.

#### Ceramics

Ceramic composites are very effective for applications where extremes of temperature or erosion-corrosion are major concerns. Ceramics have excellent abrasion resistance

when particle impingement angles are low [14] and may outlast elastomers or metals in severe applications 10:1 or better.

Ceramics basically consist of a hard phase which is set into a tough binder. The hard phase resists abrasion of impacting particles and the binder gives the material its excellent fracture toughness and corrosion resistance. Ceramics are available in many material compositions including: sintered alumina, fused zirconia-alumina, titanium oxide, tungsten carbide and silicon carbide. Silicon carbide grains cemented in silicon nitride binder produces an excellent material for most slurry pump applications which require resistance to a variety of extreme wear and corrosive conditions. Shetty, et al. [14] have demonstrated that cemented silicon carbide has a maximum and essentially constant erosion rate for particle impingement angles in the range of 50 degrees to 90 degrees. For angles less than 50 degrees, the erosion rate decreases rapidly (Figure 3). The primary wear mechanism is preferential erosion of the softer binder matrix, which causes the release of intact carbide particles. Decreasing the amount of binder increases the macro hardness of the material at the expense of toughness.

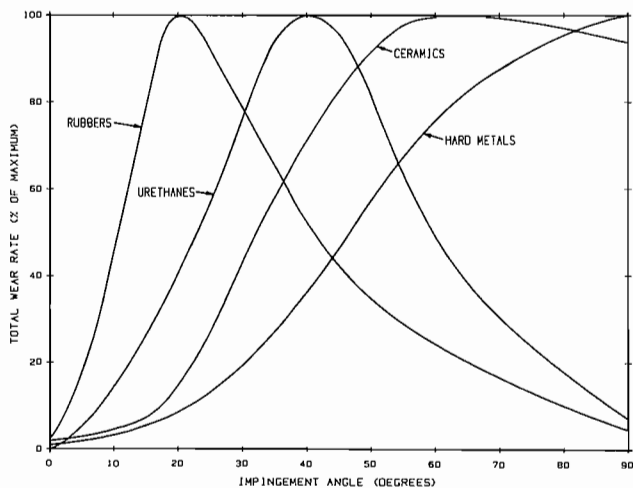

Figure 3. Typical Wear Rate Characteristics of Various Slurry Pump Materials as a Function of Particle Impingement Angle.

Silicon carbide surpasses all common metals in abrasion and corrosion resistance. It has excellent thermal conductivity, high strength, thermal shock resistance and outstanding resistance to most acids and other chemicals. Its strength at room temperature is maintained in service applications up to several thousand degrees, which is well beyond slurry pump applications.

Ceramic liners and impellers may replace hard metal or elastomers depending on the particular service. Ceramic impellers can be operated at higher speeds than rubber impellers, hence the pump can produce higher head per stage. Impeller tip speeds in excess of 130 ft/sec are possible without incurring mechanical failure [15], although in practice, tip speeds of 75 to 90 ft/sec are generally not exceeded for severely abrasive applications.

Ceramic pumps are realizing great success in phosphate mining applications where highly abrasive and corrosive gypsum slurries are removed as the by-product of fertilizer production. In coal fired generating stations, they are used for flue gas desulphurization and scrubber services where chlorides, fly ash, sulphates and sulphides limit rubber and

metal life. Ceramics may outlast conventional metals by up to 20 times in such services and rubber by up to 40:1.

Although ceramic pumps are considerably more expensive initially, the long range cost effectiveness must be considered.

It is not expected that any single material will displace the other competitive materials completely. Advances in technology are continually improving existing materials and new compounds are being created. Through experience, pump suppliers have learned that each type of material can be economically justified in certain types of service applications to optimize slurry pump performance.

## PUMP SELECTION

The objective of selecting a pump for a given service is to minimize the total cost of operation. This implies minimizing initial capital costs and associated part replacement costs and obtaining maximum efficiency to minimize energy requirements and to reduce wear rates. In order to optimize pump selection, tradeoffs must be made in one or more areas.

For a fixed head and capacity requirement, a larger pump can be selected to reduce shaft speed. The implication is that the reduced speed will improve part life, because relative velocities in the casing are reduced. However, selection of a larger pump implies higher initial and part replacement costs and a lower operating efficiency at the service point. These must be carefully accounted for in any analysis to determine total cost. In addition, the effect of oversizing a pump on wear rate must be analyzed fully. There will be a point at which oversizing the pump is no longer economically justified, because wear due to increased slurry recirculation begins to predominate and total wear rates actually increase. This becomes most apparent when slurry pumps are operated at 50 percent of BEP capacity or less. Viewing Figure 4 may be useful for visualizing how total wear varies as a function of pump output assuming a fixed operating speed. Total wear in slurry pumps is a very complex superposition of various mechanisms acting simultaneously. The relative wear curves are arbitrary for the purpose of illustration and should not be scaled.

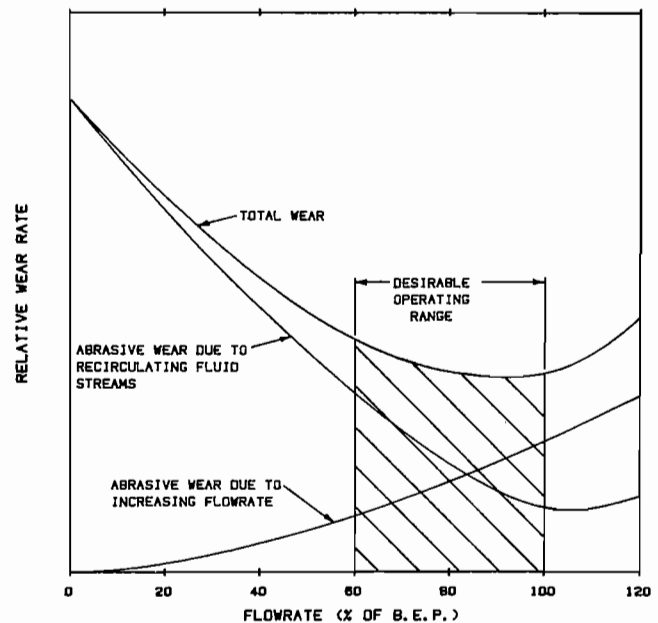

Figure 4. Effect of Operating at Off Design Capacities on Total Wear Rates in Slurry Pumps.

Slurry pumps may be oversized for several reasons:

- Liberal estimates of slurry flow rates by system designers to ensure adequate pumping capacity is available, should future throughput demands increase.
- Poor understanding of the effects of the solid phase on pump performance leading to liberal correction factors.
- Inaccurate estimates of the system resistance curve.
- Inadequate specification of the overall rheological properties of the slurry and its effect on performance.

Recirculation at off design capacities causes energy losses in the form of increased turbulence in the casing and impeller vanes which manifest themselves as a loss in pump efficiency. Associated with these recirculation phenomena are localized zones of high fluid velocity which cause higher particle impact velocities at containment boundaries. Particle impact angles deviate from the mean path geometry for which the pump is designed. Greater disparity between solid particle velocity and the mean fluid stream velocity may lead to phase separation and accelerated wear rates.

Recirculation in centrifugal pumps has not been well understood and until recently has not been given the attention it deserves. It causes reduced efficiency and at critical conditions can precipitate localized physical damage due to cavitation [1]. In slurry pumps, the added effect of solid particle recirculation to liquid recirculation causes increased localized wear due to greater exposure of the liquid end to solids impact [9, 11]. The result is premature loss of performance and component failure which increases operating costs.

*Impeller Recirculation.*

Slurry pump impellers are generally shrouded on both sides and the vanes have only two dimensional curvature. These vanes are much thicker and fewer in number than for conventional water pumps. The shrouded design is generally preferred and pump out vanes (scraper vanes) are normally included. A typical velocity field in a slurry pump which is operating at BEP is depicted in Figure 5. Impeller

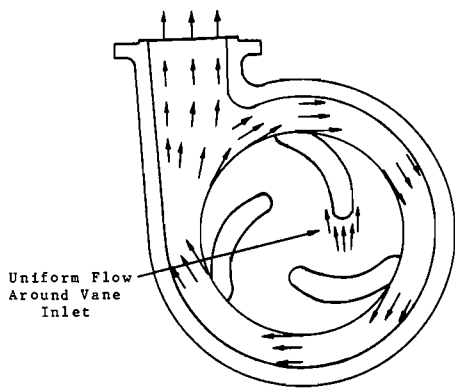

a) Representative velocity distribution in pump casing at design capacity.

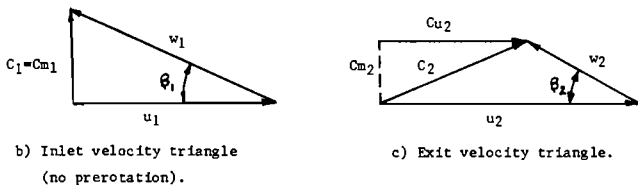

b) Inlet velocity triangle (no prerotation).  
c) Exit velocity triangle.

Figure 5. Representative Flow Profiles in Slurry Pump at Design Capacity.

and casing velocities are of low magnitude and the direction is such that the flow angles and geometrical pump angles are nearly coincident. The inlet velocity triangle (Figure 5 (b)) at BEP is such that the relative angle  $\beta_1$ , coincides with the angle of attack of the vane inlet leading edge, and the approaching mixture progresses uniformly around the vane tip. The exit velocity triangle is such that the relative angle of mixture discharge from the impeller is matched to the trailing edge of the vane and the casing cutwater.

An increase in the flowrate will increase the velocity component  $C_m$ , thereby changing the relative approach angle so the flow begins on average to strike the suction side of the vane, and causes flow reversal leading to separation from the pressure side (Figure 6 (a)). A localized vortex is created at the leading edge of the pressure side of the vane. Solid particles which are influenced by the centrifugal forces generated by this vortex impinge on the leading edge of the pressure side of the vane and act to scour out pockets of material from the vanes and shroud.

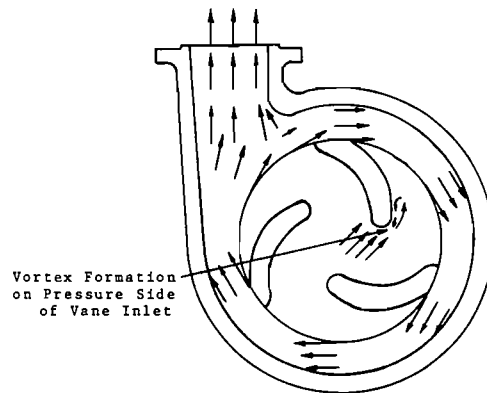

Vortex Formation on Pressure Side of Vane Inlet

a) Representative velocity distribution in pump casing at over capacity.

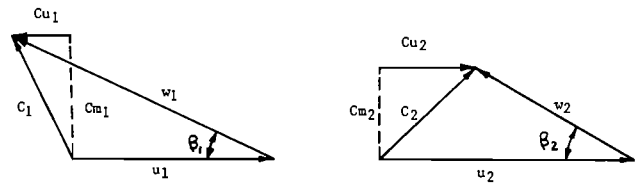

b) Inlet velocity triangle. c) Exit velocity triangle.

Prerotation component in opposite direction to impeller rotation.

Figure 6. Representative Flow Profiles in Slurry Pump at Over Capacity.

A decrease in the flowrate will reduce the velocity component  $C_m$  and change the relative angle so the approaching flow impinges on the pressure side of the vane, effectively increasing the angle of attack relative to the flow stream (Figure 7 (a)). This causes flow reversal at the suction side of the leading edge creating a vortex which causes localized wear as depicted later, in Figure 22.

In either case, the reduction in pressure associated with the formation of these vortices can lead to vapor formation and cavitation damage in zones of higher pressure where the vapor bubbles implode releasing a tremendous amount of energy. Cavitation due to recirculation is normally not a problem in most slurry pump applications, but its presence can accelerate wear rates, because particle abrasion is accentuated where cavitation damage occurs.



*Discharge Recirculation*

As a centrifugal pump is operated at partial capacities further from BEP it is unable to meet the demands of the system in which it is operating with a minimum of hydraulic losses. In attempting to deliver its design flowrate to a system which cannot accept it, a certain amount of discharge flow is recirculated back into the volute at the cutwater (Figure 7(a)). As the flow returns toward the cutwater, the velocity remains relatively low and the cutwater side of the discharge nozzle does not experience high wear. As this occurs, a portion of the flow which meets resistance in the volute as it approaches the discharge is forced through the small area between the cutwater and the impeller outer diameter. This flow is accelerated past the cutwater, due to the reduction in area, and merges with the flow being redirected from the discharge nozzle. The result is a high velocity component in a direction which is roughly towards the center of the pump. The suction and gland side wear plates are characteristically abraded downstream of the cutwater in a pattern corresponding to the velocity component. Slurry pump cutwaters are rounded and increased in thickness to accommodate this.

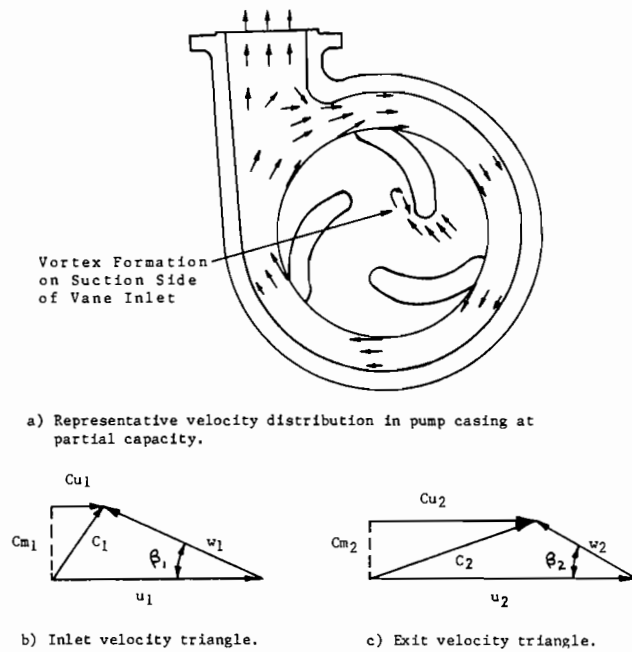

Figure 7. Representative Flow Profiles in Slurry Pump at Partial Capacity.

*Shroud Recirculation*

The tendency of the recirculating fluid stream around the cutwater is to be forced between the suction and gland walls of the casing (wear plates) and the impeller shrouds in a spiral path toward the low pressure zone of the impeller. Pump out vanes (expeller vanes) are normally provided on the outer shrouds of slurry pump impellers to reduce the ingress of particles to the suction eye or rear hub of the impeller. The effective action of pump out vanes on the gland side prevents particle ingress into the stuffing box area, and reduces the local pressure at the shaft. This helps to reduce the flush pressure requirements through the seal. Although pump out vanes are very effective at BEP where recirculating flows are minimal, the increased fluid velocities associated with recirculating flows reduce the effectiveness of pump out vanes and increased abrasion damage is done to

front and rear impeller shrouds and wear plates. The suction side wear plate is the most quickly worn part in the pump at partial capacities and must be rotated to prolong service life.

*Suction Prerotation*

The spiralling flow into the suction eye at reduced capacities tends to reinforce any prerotation present in the suction nozzle and increases abrasion damage to the suction wear plate. Stepanoff [16] indicates that at any flow other than that of the design capacity, a prerotation is induced in the pump suction nozzle. The prerotation is in the opposite direction to the impeller at higher than design capacity and is in the same direction at reduced flows (component  $C_u$  in Figures 6 and 7). Anti-prerotation vanes (or straightening vanes) are beneficial in slurry pumps to break up the prerotation vortex as it enters the impeller eye.

EXPERIMENTAL PROGRAM

In order to evaluate the wear rate of slurry pumps manufactured from various materials, numerous attrition studies have been conducted since 1972 at the Worthington test facility in Brantford, Ontario. The primary focus has been on a standard 4 in x 3 in slurry pump tested in both hard metal and rubber lined configurations (Figure 8).

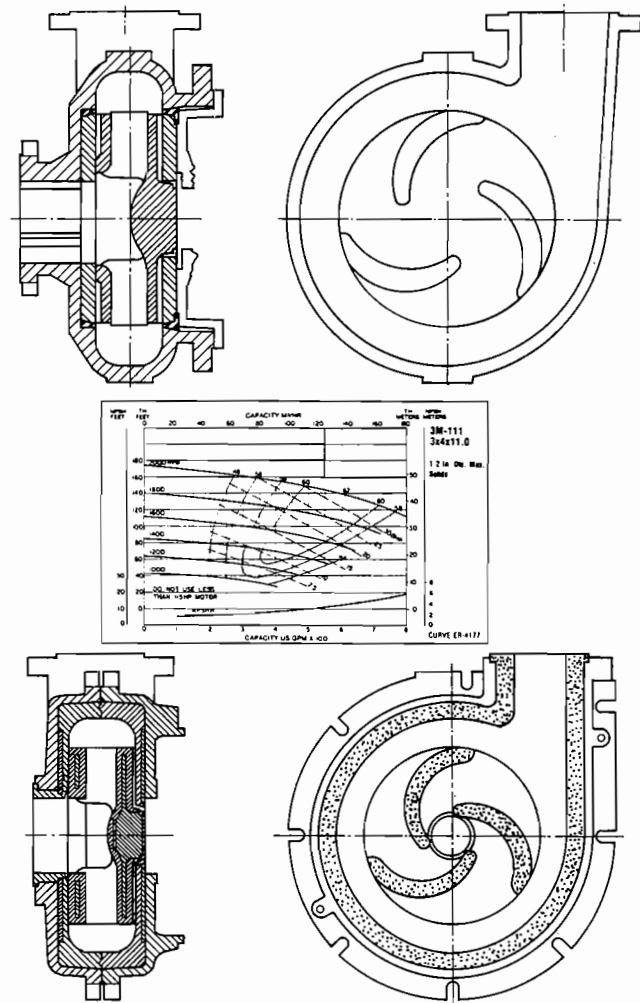

Figure 8. Four In x Three In Slurry Pump—Hard Metal and Rubber Lined.

The primary goal of the current work was to assess the relative wear rates of various liquid end materials for similar operating conditions. Since it was necessary to test many pump configurations, the tests were purposely conducted at 50 percent of BEP capacity and at maximum rated operating speeds to accelerate wear rates and reduce test time and costs. The conditions of service selected for this test program are not reflective of how a pump should be applied in an actual field installation and the data are presented as such for comparative purposes only.

Silica sand of approximate particle size 0.04 in to 0.08 in diameter was used as the abrasive medium, because of its aggressive nature and ready availability at low cost. The slurry composition was formulated at approximately eight percent concentration by weight, by mixing known weights of sand with known volumes of water. The slurry was sampled close to the pump discharge nozzle to determine actual concentration through the pump. Concentration gradients throughout the system were present due to local settling.

The attrition test facility (Figure 9) consists of a 575 U.S. gallon mixing tank in a recirculating loop of four inch steel pipe. The slurry is drawn from the bottom of the tank into the pump through a long straight length of pipe to reduce the effects of vortices in the tank. The discharged slurry is directed through two 90 degree long radius elbows back into the mixing tank. Downstream of the first discharge pipe elbow, a restrictor with a bore diameter of 1.5 in was installed to diminish pump capacity and prolong the life of the throttle valve. Further capacity regulation was achieved by adjusting the four inch rubber lined pinch valve. The pump was V-belt driven at the desired speed by a 30 hp, 1780 cpm AC motor mounted overhead of the pump. The power supply also ran a totalizing clock that indicated elapsed operating time of the pump.

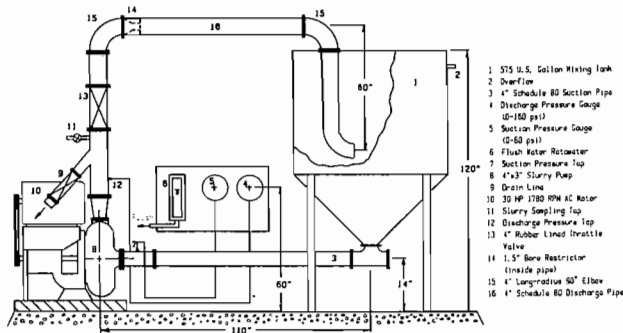

Figure 9. Slurry Test Facility.

Wear related measurements of the liquid end parts included documentation of initial part weight, overall part dimensions (diameters, thickness, etc.) and part material. All parts were photographed to maintain a visual record. Consistent measurements were used during the course of experimentation in order to obtain accurate wear data. Each time the pump was disassembled, a set of wear measurements were obtained and a series of photographs were taken.

Several measurements related to the physical properties of the slurry were also recorded. Sand particle size analyses were done before testing to verify vendor classification data. A typical size distribution for the filter sand used is shown in Figure 10. Sand specific gravity was determined by standard gravimetric techniques to be 2.65, the particle hardness is approximately 700 Brinell. Attrition rate of the slurry parti-

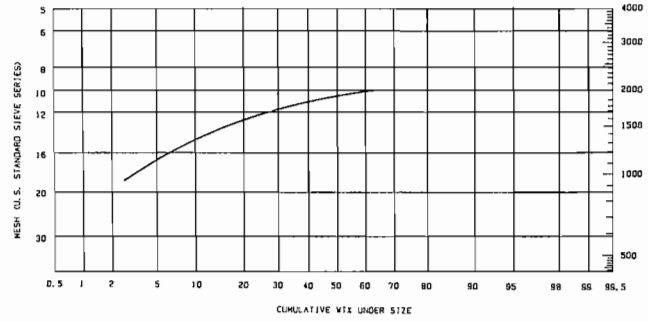

Figure 10. Particle Size Distribution of Silica Sand Prior to Testing.

cles was determined by drawing a sample of the slurry from the discharge pipe, drying it and performing a particle size analysis on the residue (Figure 11). It was determined that particle attrition was not significantly dependent on pump materials, since the curve was reproducible for each combination of materials tested. Actual slurry concentration in the

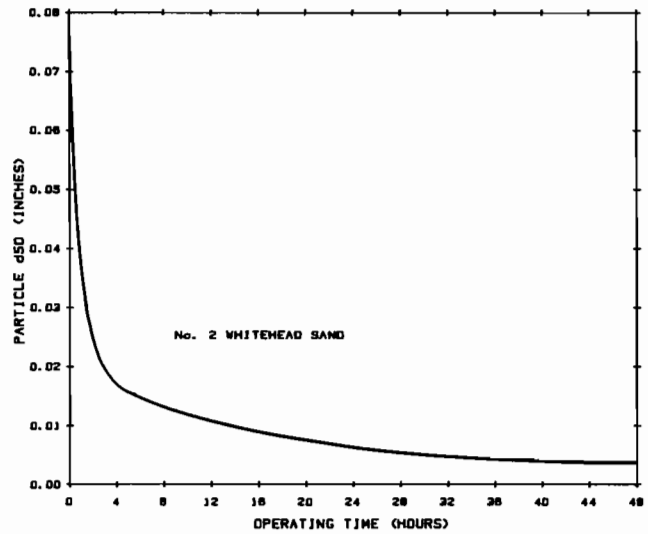

Figure 11. Sand Attrition in Slurry Loop Plotted as Particle d50 vs Operating Time.

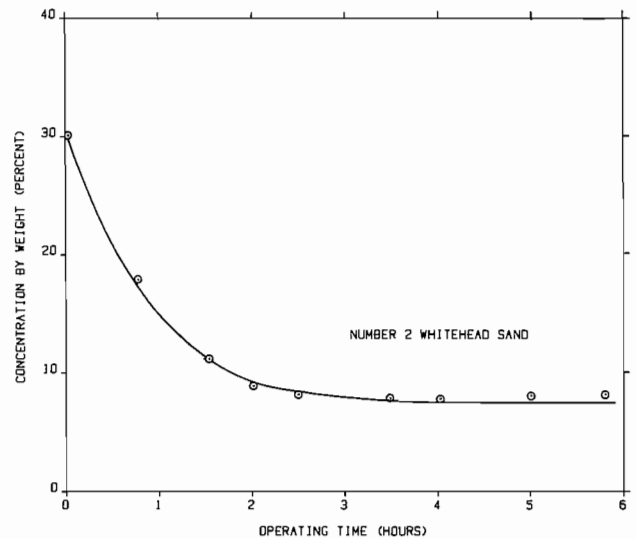

Figure 12. Sand Slurry Concentration as a Function of Operating Time.



discharge pipe was determined from the same samples (Figure 12). The concentration was very high initially (30 percent) due to solids settling in the suction pipe, but established itself at the nominal value after two hours of operation, due to particle attrition and mixing. This is an inherent difficulty experienced with recirculating test loops when doing slurry experiments.

*Procedure*

The pump was assembled after a dimensional check of the liquid end parts was completed and a series of photographs were taken. The pump was then installed at the test facility and the impeller front axial clearance was accurately set (nominally 0.015 in). The system was started up on clear water. In order to maintain adequate cooling in the stuffing box and minimize dilution, a through flush configuration was adopted. The flush water flowrate was accurately adjusted after the sand was added.

Once the system stabilized on clear water, the suction and discharge pressure gauges were purged. The flowrate was then adjusted using the pinch valve until the differential pressure corresponding to 50 percent of BEP capacity was obtained for the operating speed. The prescribed weight of silica sand was then added to the tank over a period of several minutes and the packing flush was adjusted. The slurry was dumped and changed at 48 hour intervals.

The initial test series was conducted on a Ni-hard 1 pump, to establish a baseline for other material tests. The primary focus was the wear rate of the suction side wear plate, since it was to be substituted with various polyurethane wear plates for subsequent tests. Results from testing of four different urethane materials are reported. Finally, test data for natural

rubber, neoprene and polyurethane fully lined pumps are presented to illustrate the effect of material properties on wear resistance.

**NI HARD 1 RESULTS**

The Ni-hard pump was tested for a total of 437 hours of slurry operation at 2000 cpm at 50 percent BEP. The pump was inspected after 148, 293 and 437 hours at which times wear measurements and photos were taken.

*Casing*

During the test period, the casing sustained some localized gouging; however, the weight only changed from 155 pounds to 145 pounds. Casing wall thickness on the volute was measured at locations corresponding to bolt slots on the casing backface, using a vernier caliper mounted on a special positioning track (Figure 13). The severity of the wear in the volute changed with angular position relative to the cutwater. The change in volute cross section geometry at various chosen locations after 437 hours is illustrated in Figure 14.

POSITION	RELATIVE CHANGE IN INITIAL CASING DIMENSION (PERCENT)		
	148 HOURS	293 HOURS	437 HOURS
A	0	7.1	10.0
B	17.7	41.4	50.5
C	13.0	32.1	40.2
D	11.7	31.0	35.9
E	10.3	20.1	42.5
F	9.4	20.0	28.9
G	8.7	20.6	27.2
H	6.7	13.9	31.1
I	9.5	11.0	15.0
1	0.5	1.0	1.0
2	0.5	1.0	1.0
3	1.0	2.7	3.0
4	3.0	3.0	3.0
Dia. 5	1.2	1.5	1.5
Dia. 6	0.3	0.3	0.3
Dia. X	0.4	0.8	1.5
Dia. Y	0.2	0.2	0.5
Dia. Z	0.5	0.8	0.8
CASING WEIGHT	2.6	4.5	6.4

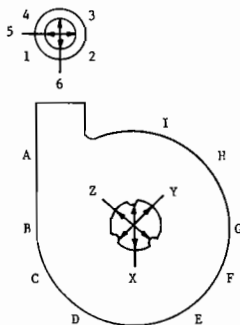

NOTE: This view is looking into the casing through the backface.

Figure 13. Casing Wear Measurement Locations. Note: This view is looking into the casing through the backface.

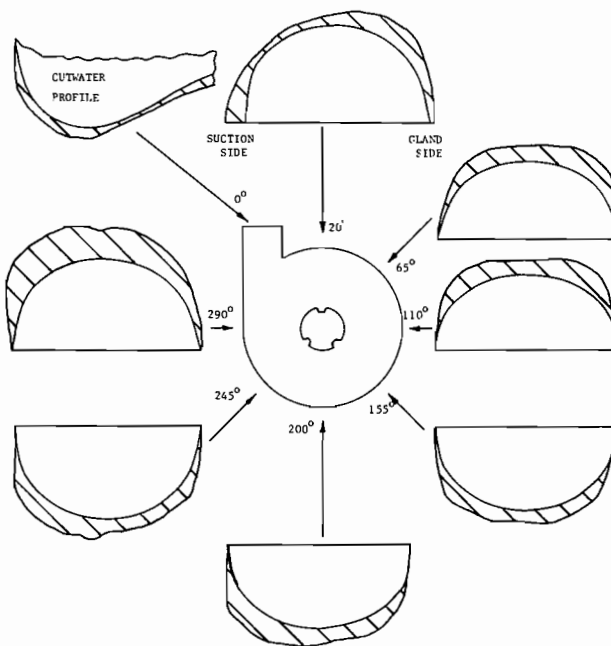

Figure 14. Casing Wear Profiles at Various Locations in the Volute.

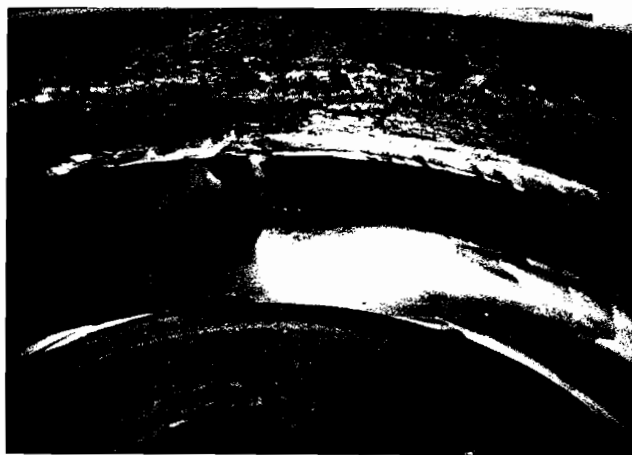

Figure 15. Ni Hard Casing Cutwater at 437 Hr of Slurry Operation.

There was very little wear at the cutwater (Figure 15). The surface was smooth and polished with no detectable gouging. At approximately 22 degrees clockwise from the cutwater, shallow scalloped pockets appeared on the volute surface (Figure 15). Continuing around the casing the same wear pattern was evident, but the scallops became longer and deeper (Figure 16). At approximately 290 degrees from the cutwater (position B, Figure 13 and Figure 17) the gouges became almost 0.5 in deep and roughly 2.0 in long. The rapid wear in the casing is attributed to the ardent conditions purposely prescribed for these tests.

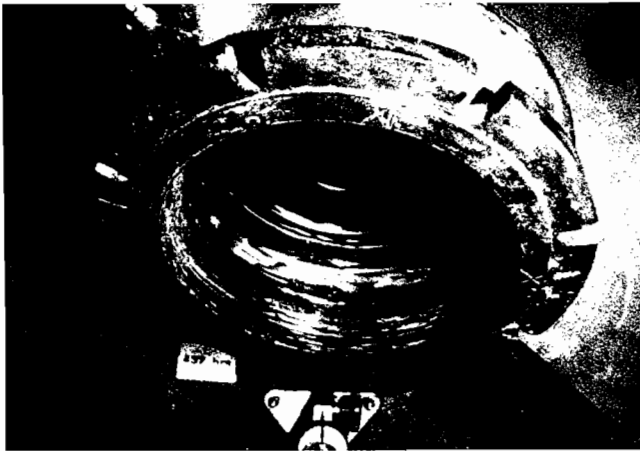

Figure 16. Ni Casing Volute at 437 Hr of Slurry Operation.

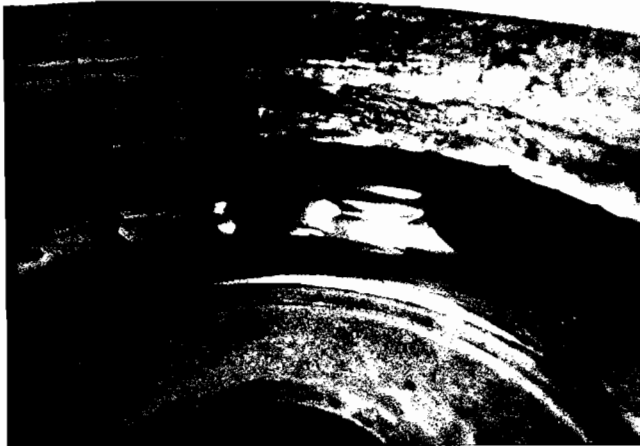

Figure 17. Ni Hard Casing Volute Approaching Discharge Nozzle at 437 Hr. Note sudden discontinuity of wear pattern.

The discharge nozzle was virtually not worn after 437 hours. The casing suction nozzle also experienced very little wear during the test. The anti-rotation guide vanes were in excellent condition for the most part, although completely eroded away at the inner most tips due to severe gouging (Figure 18).

*Impeller*

Dimensional measurements and impeller weights are summarized on Figure 19. The measurements indicated are the average percentage change of the initial measurement taken at the corresponding positions for each of the three impeller vanes. The impeller was generally in good condition at the end of the test, having lost 3.8 pounds or 10

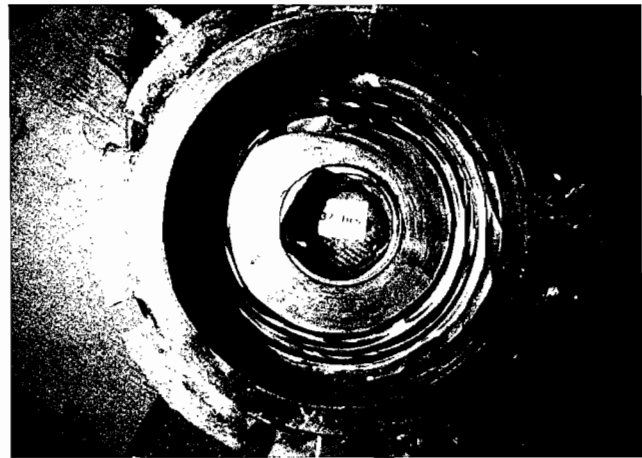

Figure 18. Ni Hard Suction Side Wear Plate in Situ at 437 Hr. Note considerable wear at suction inlet on anti-rotation vanes.

percent of its initial weight. The outside diameter at the vane tips changed from 10.74 in to 10.72 in. The front shroud pump out vanes were severely eroded, especially at the tips (compare Figures 20 and 21). The rear shroud pump out vanes were similarly worn but not to the same extent.

The impeller vane passages were in excellent condition, aside from a small gouge emanating from the leading edge of each vane at the hub and projecting into the flow passage along the low pressure side of each vane (Figure 22). The suction wear ring was still well defined, although the diameter was no longer round because of gouging at the vane inlet on the suction shroud.

	RELATIVE CHANGE IN DIMENSION FROM INITIAL VALUE (PERCENT)		
	148 HOURS	293 HOURS	437 HOURS
1. INTERNAL WIDTH	3.6	3.6	5.1
2. OVERALL WIDTH	0.2	0.3	0.4
3. FRONT SHROUD THICKNESS	11.5	9.6	13.4
4. BACK SHROUD THICKNESS	3.8	3.8	5.8
5. STAGGERED WIDTH (FRONT)	0.8	0.9	1.3
6. STAGGERED WIDTH (REAR)	0.7	0.7	0.7
7. OVERALL WIDTH FROM HUB	0	0.4	0.4
8. IMPELLER EYE DIAMETER	1.1	2.6	3.4
9. IMPELLER DIAMETER	0	0.2	0.2
10. WEIGHT	6.2	8.3	10.3

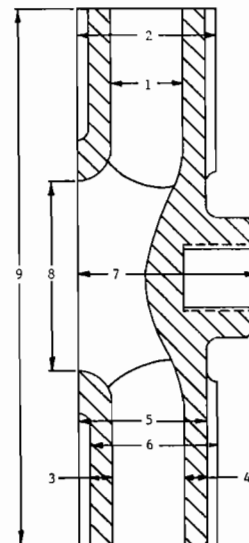

Figure 19. Ni Hard Impeller Wear Measurement Locations.

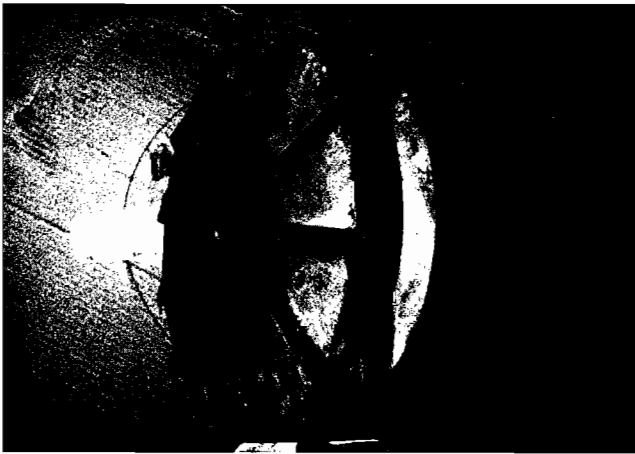

Figure 20. Ni Hard Impeller Prior to Test Program.

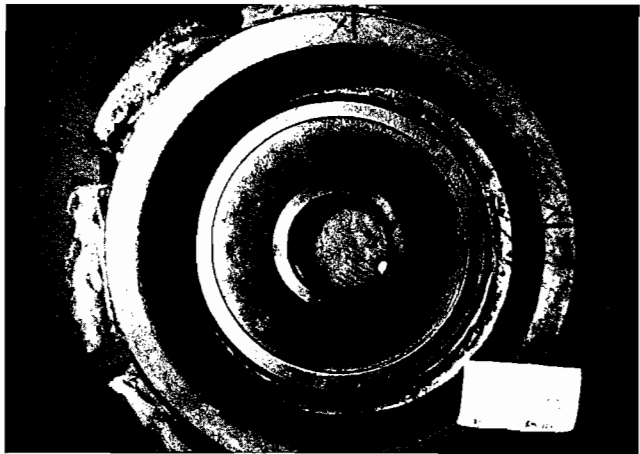

Figure 23. Ni Hard Suction Wear Plate in Casing Prior to Wear Testing.



Figure 21. Ni Hard Impeller, 437 Hr. Note erosion of vane tips and pump out vanes.



Figure 24. Ni Hard Suction Wear Plate at Test End. Wear plate has holed downstream of cutwater.

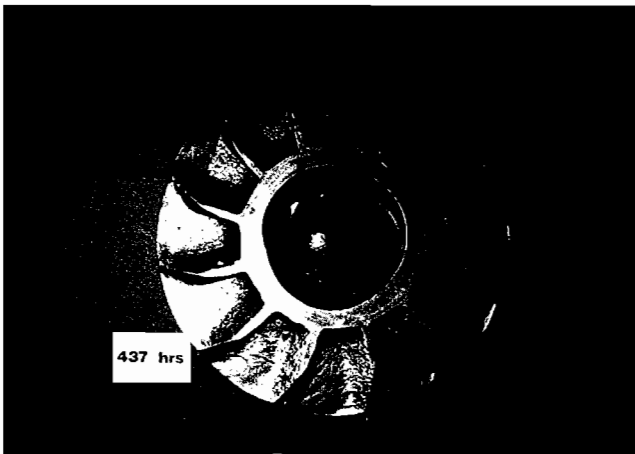

Figure 22. Ni Hard Impeller Front View at 437 Hr. Pump out vanes considerably worn. Vane inlets worn on suction side.

**Wear Plates**

The suction wear plate was the most severely worn of all parts due to slurry recirculation. The plate was severely worn adjacent to the casing cutwater with a four inch long tear drop shaped gouge cutting across the outer raised wear

LOCATION	0-148 hrs.	148-293 hrs.	293-437 hrs.	TOTAL (0-437 hrs)
A	0.093	0.334	0.083	0.510
B	0.029	0.010	0	0.039
C	0.032	0.003	0.002	0.037
D	0.096	0.047	0.047	0.190
E	0.083	0.058	0	0.141
F	0.036	0.013	0.006	0.055
G	0.028	0.007	0.003	0.038
H	0.064	0.059	0.038	0.161
L	0.045	0.011	0	0.056
M	0.041	0.016	0	0.057
N	0.042	0.018	0	0.060
O	0.038	0.009	0.002	0.049
WEIGHT LOSS	1.51 lb	1.27 lb	1.14 lb	3.92 lb

Dimensions A through O above are expressed in inches of surface material lost during the specified time of operation. The measurements were taken referenced to the casing backface (below) at the location shown.

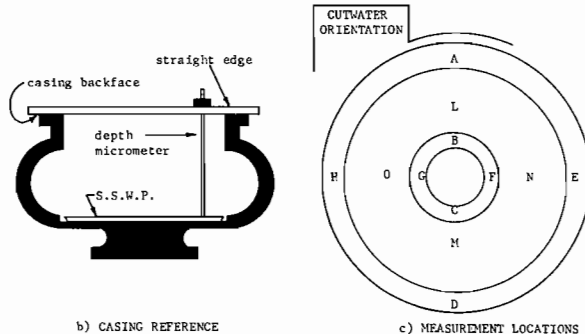

Figure 25. Ni Hard Suction Side Wear Plate Measurement Locations.

surface. A hole approximately 1.5 in by 0.75 in was worn through the plate and a deep gouge had formed around the entire periphery of the wearplate (Figures 18, 23 and 24). The suction wear ring was considerably eroded adjacent to the three suction nozzle anti-rotation vanes. The change in material thickness for the three observation periods is summarized in Figure 25.

The gland side wear plate did not wear appreciably during the test period (Figures 26 and 27). The total weight loss was only two percent of initial weight (Figure 28). There was a noticeable gouge adjacent to the casing cutwater approximately 0.07 in deep. There was no change in outside or inside diameters and the raised machined faces were still well defined.

**POLYURETHANE WEAR PLATES**

Wear tests were conducted in a similar manner on several polyurethane materials by substituting urethane suction wear plates for the Ni-hard plate. The remainder of the pump, including the impeller, was of hard metal construction. The purpose of the tests was to evaluate polyurethane as a wear resistant material and determine which products, if any, could provide better part life than Ni-hard material. The suction wear plate was selected for study, because it was the most severely abraded part during the hard iron tests, and is easily manufactured in urethane.

Results for four urethane materials are reported. The materials range in hardness from 75 to 95 Shore A durometer. Each of the parts was made to company specifications by

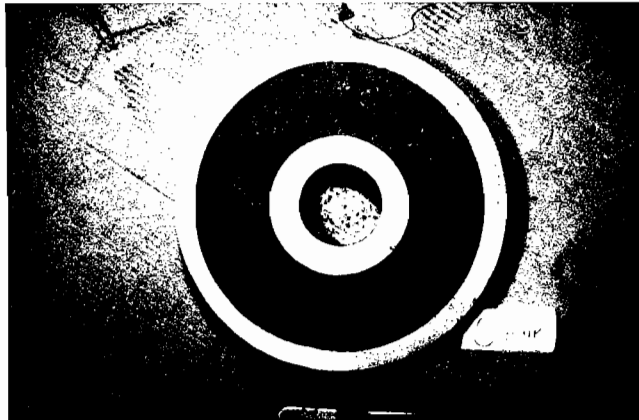

Figure 26. Ni Hard Gland Side Wear Plate Prior to Test Program.



Figure 27. Ni Hard Gland Side Wear Plate at End of Test Program—437 Hr.

LOCATION	0-148 hrs.	148-293 hrs.	293-437 hrs.	TOTAL (0-437 hrs)
A	0.020	0	0.050	0.070
B	0.005	0	0.010	0.015
C	0	0	0.005	0.005
D	0.005	0.010	0	0.015
E	0	0	0.050	0.050
F	0.005	0	0.020	0.025
G	0	0.005	0.005	0.010
H	0.007	0.005	0	0.012
L	0	0.010	0.010	0.020
M	0.002	0.003	0.020	0.025
N	0.005	0	0.030	0.035
O	0.002	0.003	0.010	0.015
WEIGHT LOSS	0.11 lb	0.11 lb	0.10 lb	0.32 lb

Values in the table indicate the loss of material thickness at the location specified in the diagram below.

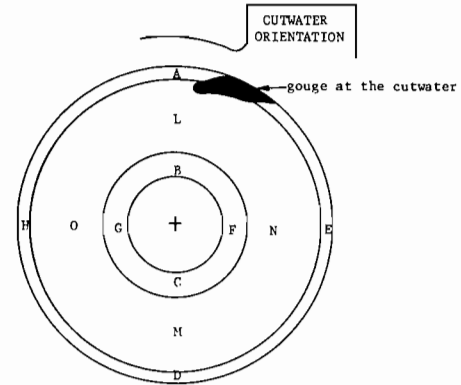

Figure 28. Ni Hard Gland Side Wear Plate Measurement Locations.

a different vendor for the test program. The tests were conducted in exactly the same manner as the hard metal pump tests and the wear measurements were made as for the Ni-hard wear plate (Figure 25). The wear measurements are summarized on Table 2.

The first test series was done on a polyester base urethane of 95 Shore A durometer hardness. The wear plate in the casing prior to testing is shown in Figure 29. After 186.6 hours of slurry operation, the pump was dismantled to inspect the plate (Figure 30). Clearly the wear plate has been severely gouged about the outer diameter (uniform ring 0.2 in maximum depth and 0.5 in maximum width around the periphery) and adjacent to the cutwater (large gouge approximately 5.0 in long, 0.5 in maximum depth and 1.1 in

Table 2. Suction Wear Plate Measurements for Various Materials Tested.

	N1 Hard	Urethane 1	Urethane 2	Urethane 3	Urethane 4
Initial Weight (Pounds)*	15.12	3.56	3.86	4.15	3.85
Final Weight (Pounds)	11.20	2.56	3.73	4.02	3.53
Test Duration (Hours)	437	186	388	345	575
Material Hardness	555BHN	95A	80A	84A	75A
Maximum Slurry Temp. (°F)	153	124	155	151	155
A	0.510	0.570	0.189	0.078	0.030
B	0.039	0.127	0.041	0.022	0.023
C	0.037	0.225	0.022	0.007	0.008
D	0.190	0.237	0.040	0.074	0.062
E	0.141	0.312	0.133	0.092	0.053
F	0.055	0.178	0.047	0.007	0.013
G	0.038	0.095	0.030	0.019	0.004
H	0.161	0.258	0.065	0.093	0.039
L	0.056	0.038	0.093	0.079	0.031
M	0.057	0.088	0.038	0.033	0.026
N	0.060	0.097	0.078	0.033	0.017
O	0.049	0.045	0.040	0.084	0.012

\*Total weight includes structural support plate (1.73 pounds) for elastomeric materials. Dimensions A through O are expressed in inches of surface material removed during the indicated period of operation. Measurements referenced to the casing backface (Figure 25c)

maximum width). The suction eye has also been considerably gouged (maximum diameter change approximately 0.8 in) and is considerably distorted. Some gouging at the inner tips of the hard metal anti-rotation vanes is also evident, but in general the casing has not been worn in the vicinity of the wear plate inlet eye.

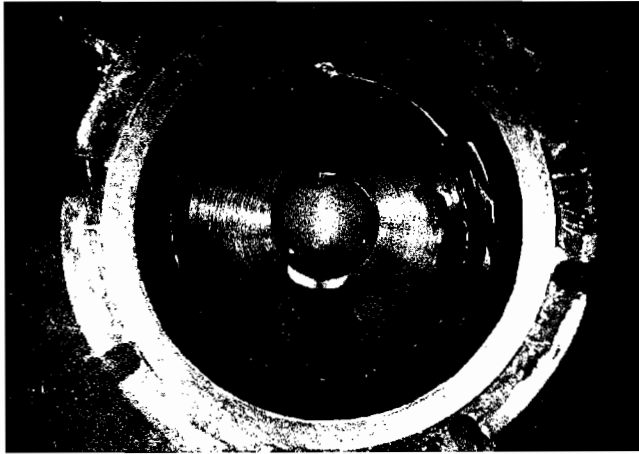

Figure 29. First Urethane Suction Wear Plate in 3M111 Casing Prior to Testing.

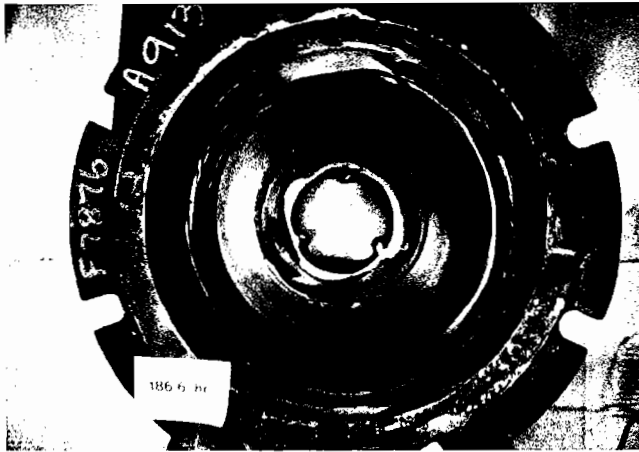

Figure 30. First Urethane Plate in Situ After 186.6 Hr. Testing.

A deep cut approximately 6.5 in in diameter and concentric to the suction inlet was evident. This may have arisen due to a sharp piece of tramp material passing between the wear plate and impeller front shroud. This type of cutting tends to accelerate abrasive wear in the vicinity of the tear and could not be tolerated to any extent in industrial applications where there is a possibility of tramp material entering the pump.

The second wear plate tested was a polyether base of 80 Shore A durometer hardness. This material was notably more resilient than the first material. The plate is shown prior to testing (Figure 31) and after 388 hours (Figure 32) at which point the test was halted.

This material yielded superior abrasion resistance to both the first urethane material and the original Ni-hard wear plate. Depth measurements (Table 2) indicated the maximum wear loss at the cutwater was approximately 0.2 in. A slight indentation corresponding to the diameter of the impeller suction wear ring was the only other place of localized wear. The inside diameter of the wear plate had

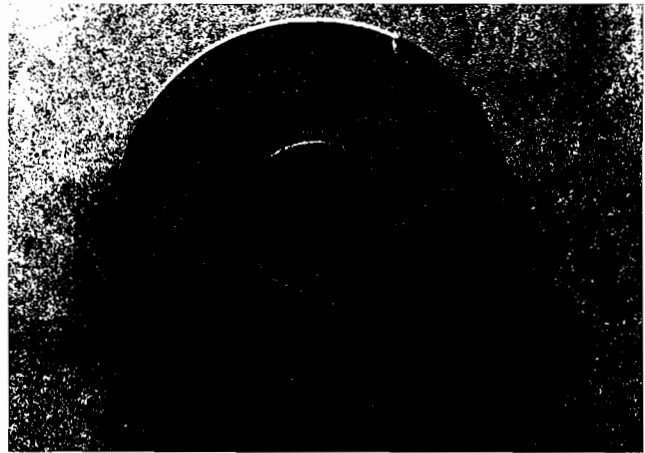

Figure 31. Second Urethane Wear Plate Prior to Testing.

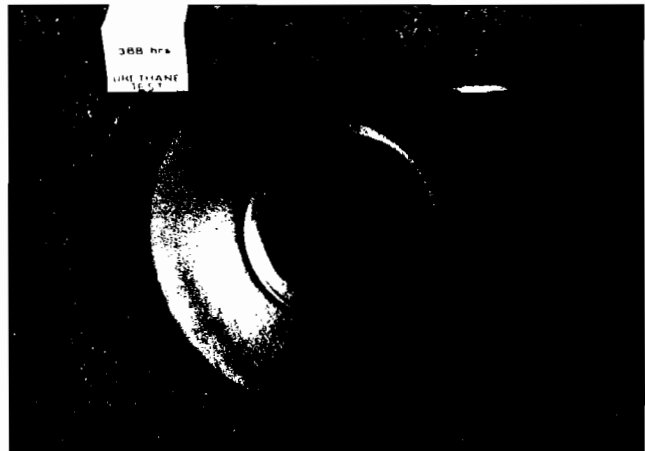

Figure 32. Second Urethane Wear Plate After 388 Hr of Slurry Service.

increased from 4.0 in to 4.1 in and remained circular. The wear plate lost a total of 0.13 pounds in 388 hours which represents approximately 6 percent urethane volume loss. The wear resistance of this material in a severely abrasive slurry was considered to be exceptional.

The next material tested was very similar in composition to the second material, but it was somewhat harder (84 Shore A durometer). The part is shown prior to testing in Figure 33.

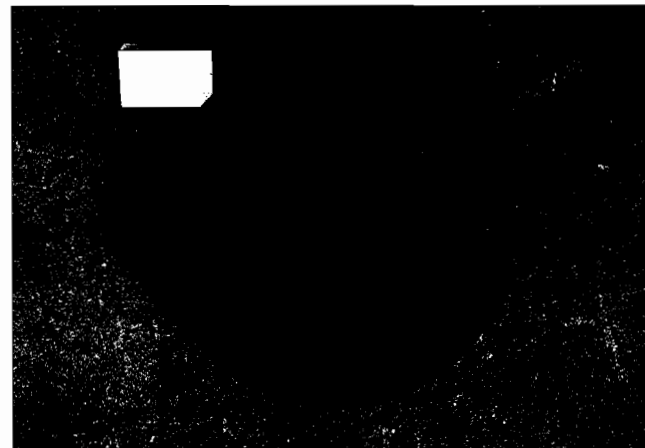

Figure 33. Third Urethane Wear Plate Prior to Testing.

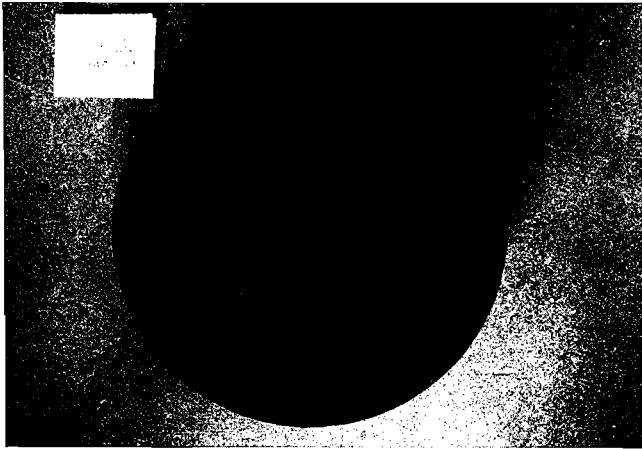

Figure 34. Third Urethane Wear Plate After 348 Hr of Slurry Service.

After 348 hours of operation the plate had lost a total of 0.13 pounds or 5.4 percent of initial weight. The extent of material removal ranged from approximately 0.10 in maximum at the outer periphery to 0.02 in at the inner diameter. The gouge at the cutwater (Figure 34) was similar to the second material tested.

The fourth urethane tested was a polyether base of 75 Shore A durometer hardness. It was noticeably softer than the previous two test materials. At test termination, the wear plate had accumulated 575 hours of total operation with very little wear evident (compare Figures 35 and 36). The gouge at the cutwater was considerably smaller than for the other test samples and the total urethane volume loss was only 3.15 percent of the initial urethane volume. The urethane's wear resistance was not affected by the 155°F slurry. The urethane plate in the Ni-hard casing at 418 hours of operation is shown in Figure 37. Note that the casing suction nozzle and volute are considerably gouged, yet the urethane is virtually intact. This material gave superior results to any other material tested.

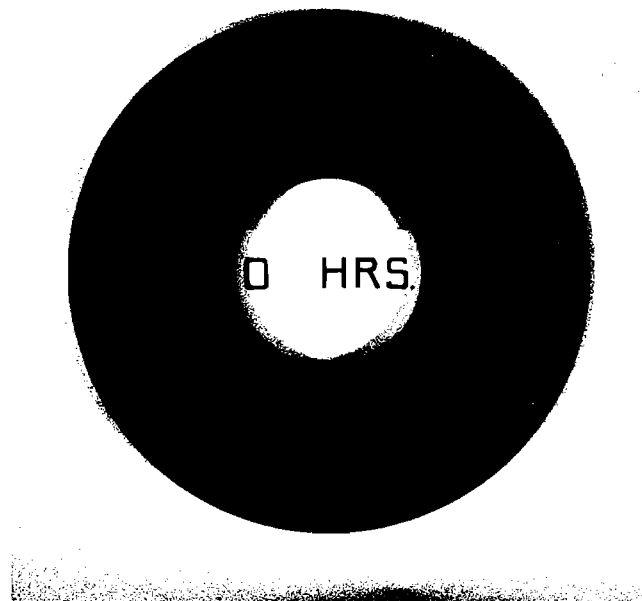

Figure 35. Fourth Urethane Wear Plate Prior to Testing.

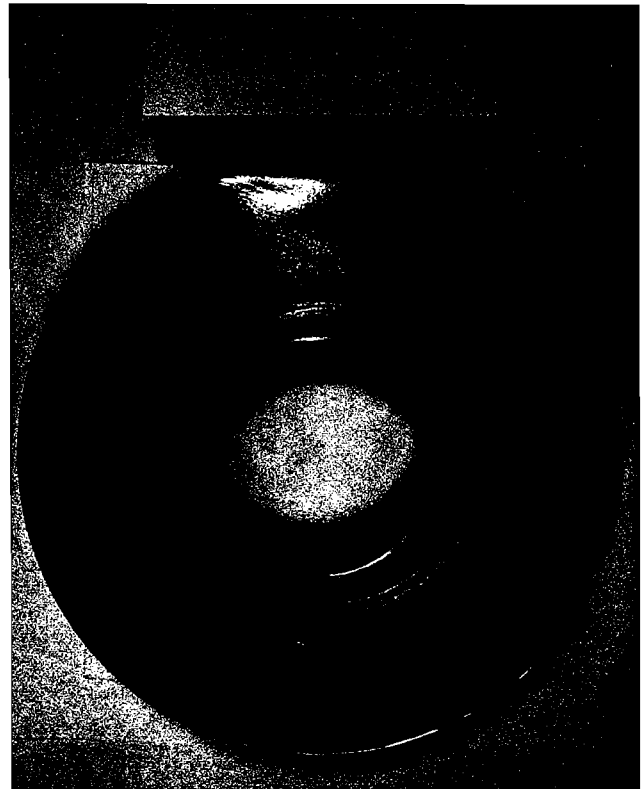

Figure 36. Fourth Urethane Wear Plate at End of Test Program.

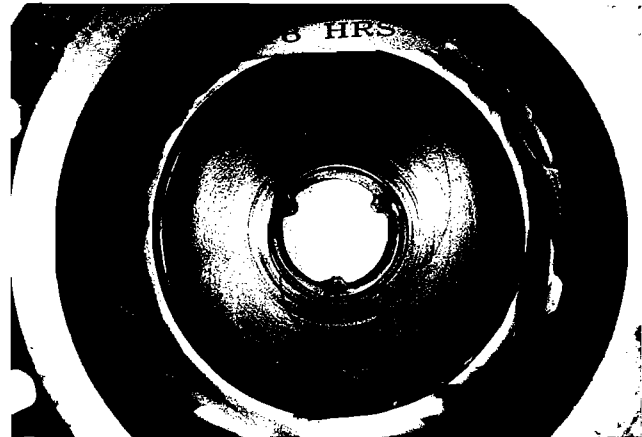

Figure 37. Fourth Urethane Wear Plate in Situ at 418 Hr. Note spiral pattern into suction eye.

#### POLYURETHANE PUMP RESULTS

A complete urethane pump (liners and impeller), manufactured from material number three was assembled for a test series. Testing was conducted in exactly the same manner as previously described. The pump was dismantled and inspected at 142, 285, 406 and 429 hours of operation. The pump was operated for approximately 40 hours on clear water service prior to the slurry tests, to determine whether any swelling due to water absorption took place which would affect the front axial clearance. A small amount of swelling did occur during this period (less than 0.3 percent by volume) and the front clearance was set to 0.060 in for the slurry tests. This clearance was adopted, since there were no front pump-out vanes on the impeller to prevent larger solid





Figure 38. Urethane Suction Liner Prior to Test Program.

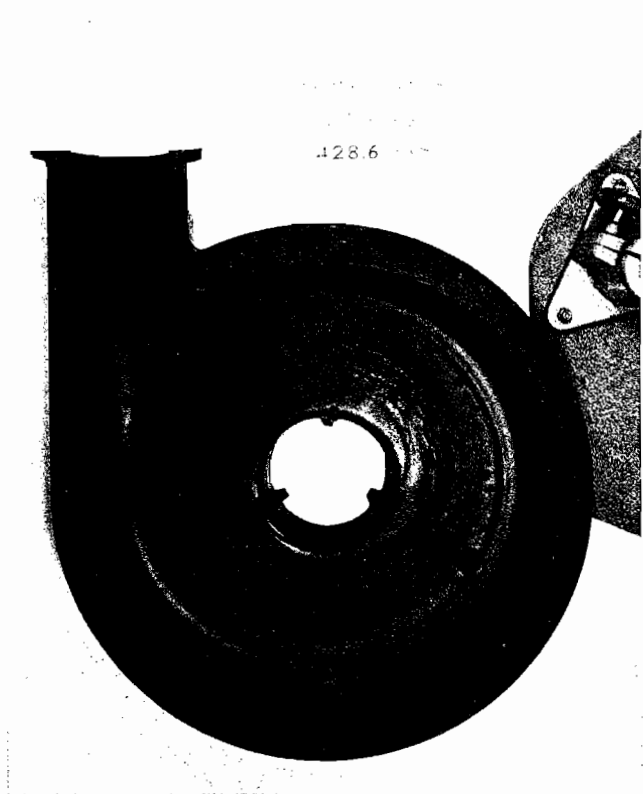

Figure 40. Urethane Suction Liner After 429 Hr of Operation.

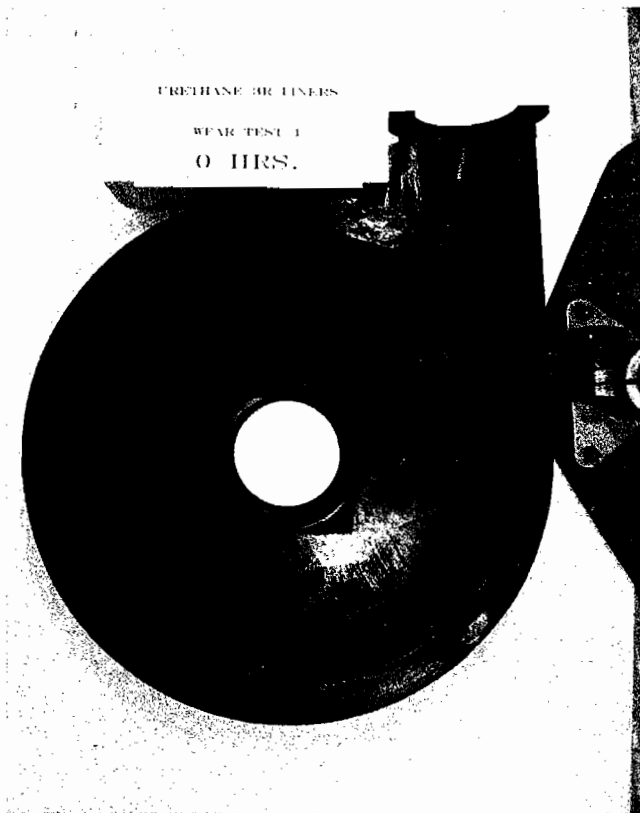

Figure 39. Urethane Gland Liner Prior to Test Program.

particles from ingressing between the suction liner and the impeller front shroud.

The suction and gland liners are shown in Figures 38 and 39 prior to the test program. The change in weight of the material during the test program is summarized in Table 3.

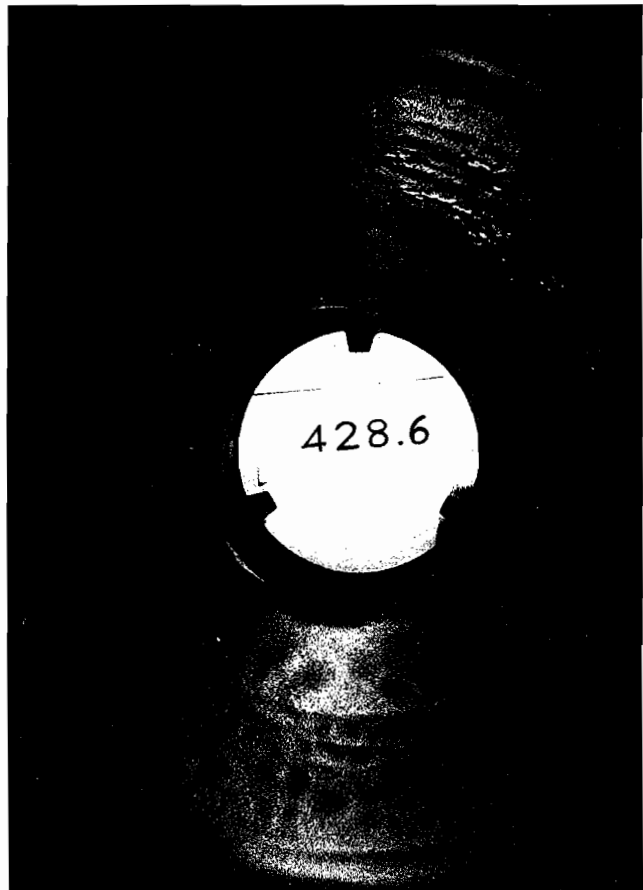

Figure 41. Wear at Suction Nozzle After 429 Hr of Operation.

Table 3. Wear Summary—Elastomeric Pump Liners.

	Gland Side Liner			Suction Side Liner		
	Urethane	Nat. Rubber	Neoprene	Urethane	Nat. Rubber	Neoprene
Test Duration (Hours)	428	200	70	428	200	70
Number Slurry Changes	13	9	3	13	9	3
Initial Weight (Pounds)	20.483	19.418	22.527	20.154	20.432	23.430
Final Weight (Pounds)	20.459	19.325	22.407	19.689	20.375	23.097
Weight Loss (Pounds)	0.024	0.093	0.120	0.465	0.057	0.333
Percent Weight Change from Initial	0.12	0.48	0.53	2.31	0.28	1.42
Percent Weight Change per Slurry Change	0.01	0.05	0.18	0.18	0.03	0.47
Hardness (Shore A)	75-77	35-36	50	75-78	34-35	50-51

Liner weights shown include metal support plates (approx. 12 pounds).  
Parts dried for 48 hours at 130°F prior to weighing.

The test was halted at 429 hours of operation, when it was discovered that the suction nozzle was worn through the urethane, exposing a 1.25 in × 0.12 in section of the underlying steel support plate (Figures 40 and 41). Holing of the urethane was considered to be the criterion for failure. The gouge was formed because the two lower anti-rotation vanes were severely worn, due to suction prerotation. The suction liner lost approximately 0.1 in of material from the surface directly opposite to the impeller. The recessed surface remaining had a dimpled appearance with fine pitting (Figure 40). The volute and discharge area showed no noticeable wear.

The gland side liner (Figure 42) did not experience significant wear. There was some shallow scoring present and some small pieces of material had broken loose, however original blemishes on the surface were still visible.

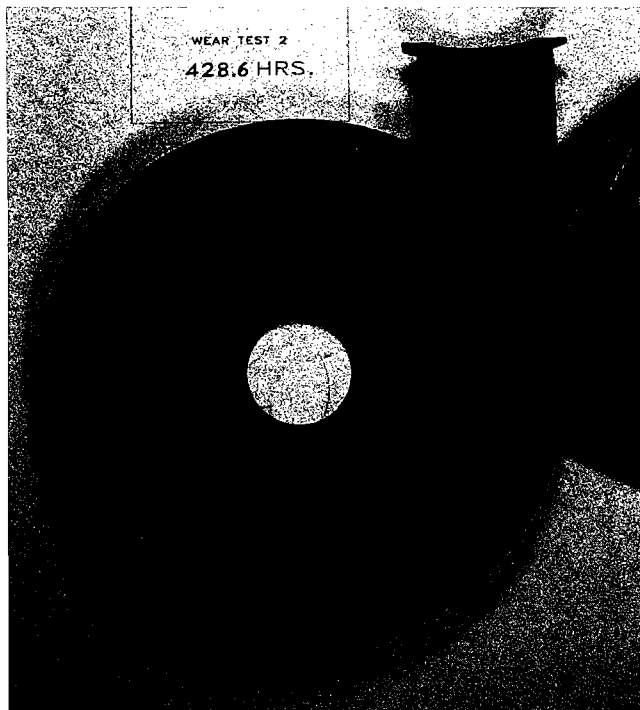

Figure 42. Urethane Gland Liner After 429 Hr of Operation.

The front surface of the impeller had worn appreciably. The surface was finely pitted and shallow concentric grooves were evident on the surface (Figure 43). The only other region of significant wear was on the shrouds at the impeller outer diameter and the rear shroud pump out vanes (Figure 44).

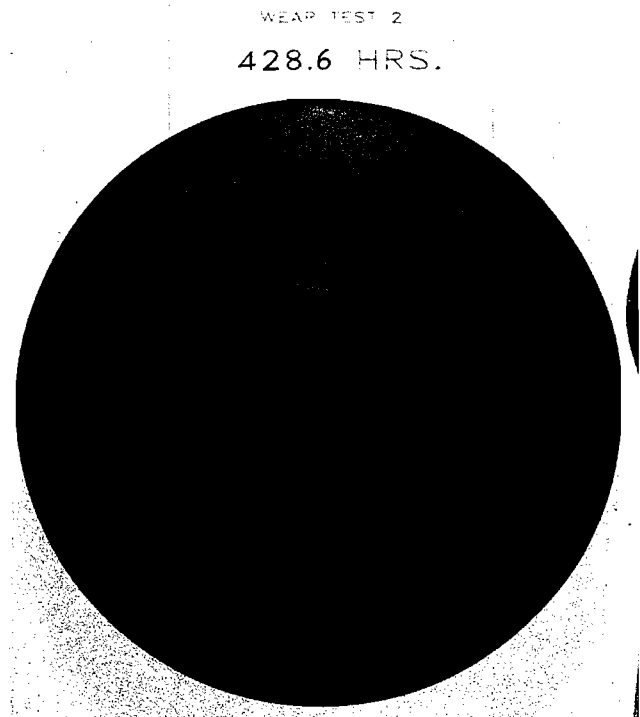

Figure 43. Suction Side of Urethane Impeller After 429 Hr of Operation.

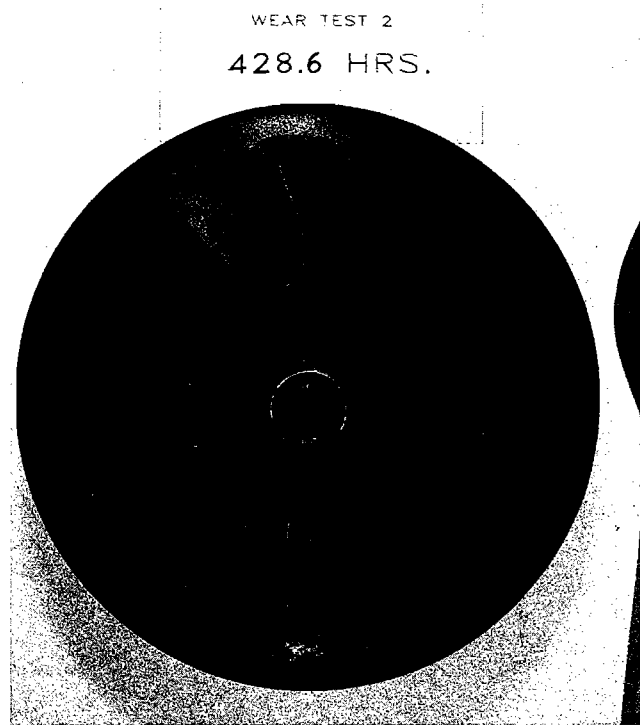

Figure 44. Gland Side of Impeller After 429 Hr of Operation.

## RUBBER PUMP RESULTS

In order to establish a further basis for comparisons, wear tests were done on two rubber compounds—natural rubber and neoprene. The physical properties as supplied by the vendor are summarized on Table 4.

Table 4. Physical Properties of Elastomer Pump Materials as Provided by Vendor.

	Urethane 3	Natural Rubber	Neoprene
Hardness (Shore A)	84 ± 5	38 ± 5	50 ± 5
Specific Gravity	1.05	0.99	1.40
Tensile (P.S.I.)	4400	2920	2480
Elongation (%)	575	700	700
Abrasion index (NBS)	160	45	90
Modulus (P.S.I.)	1200 at 300%	725 at 500%	—

The test procedure was somewhat different in that the operating speed was reduced to 1600 cpm and the sand slurry was changed every 24 hours, rather than every 48 hours. It had been determined during the course of previous tests with these materials that wear of rubber pumps was minimal after 24 hours, due to particle attrition, and the full series of tests could be completed more quickly on a 24 hour cycle.

The wear data are presented as weight loss of the liners, since water absorption made it difficult to obtain accurate and repeatable dimensional measurements. The parts were cleaned and then dried for a 48 hour period at 130°F, before and after each test sequence, to ensure that any excess moisture in the liners was removed.

The neoprene liners were tested for a total of 70 hours, at which time the test was halted due to holing of the liner at the suction inlet (Figure 45). The inlet guide vane tips were worn round and the steel support plate was slightly exposed. The liner face was worn adjacent to the impeller front shroud, but no wear was apparent at the cutwater or in the volute. The liner lost 1.4 percent of its initial weight in the 70 hour period (Table 3). Conversely, the gland liner showed no perceptible signs of wear (Figure 46) and experienced only 0.5 percent weight change, which itself may be within the experimental error of the measuring technique. The rapid wear of the suction liner demonstrates the poor performance of neoprene in a severely abrasive service.

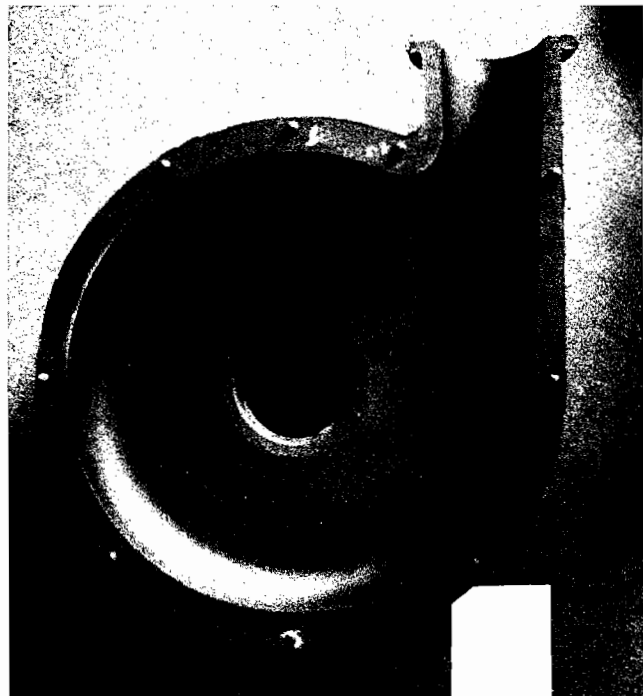

Figure 46. Neoprene Gland Liner After 70 Hr of Slurry Operation.

The natural rubber liners were tested for a period of 200 hours (Figures 47 and 48). Neither part sustained significant localized wear, and measured weight changes were minimal (Table 3). On the average, the neoprene liners sustained more volume loss in 70 hours than the rubber liners did after 200 hours of operation.

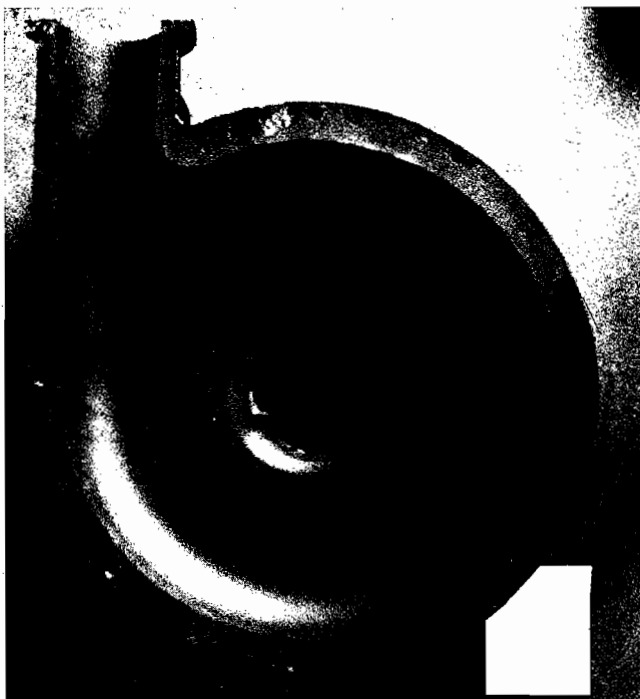

Figure 45. Neoprene Suction Liner After 70 Hr of Slurry Operation.

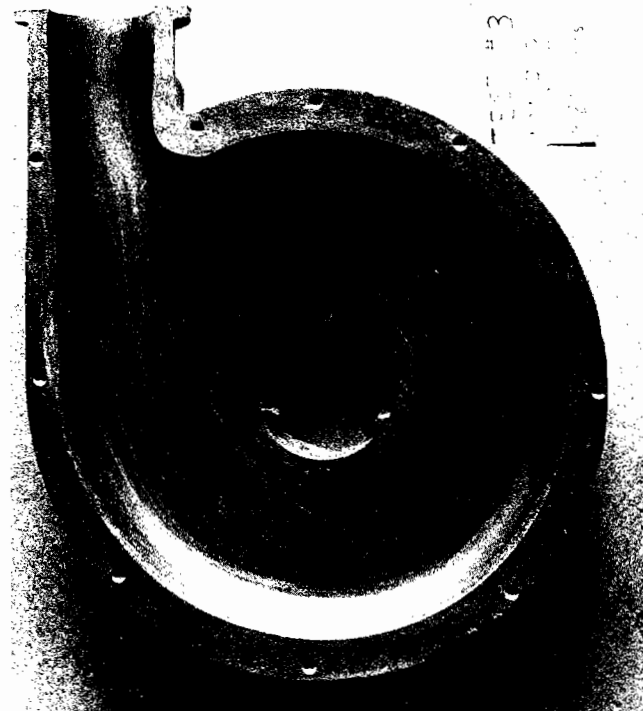

Figure 47. Natural Rubber Suction Side Liner After 200 Hr of Slurry Operation.

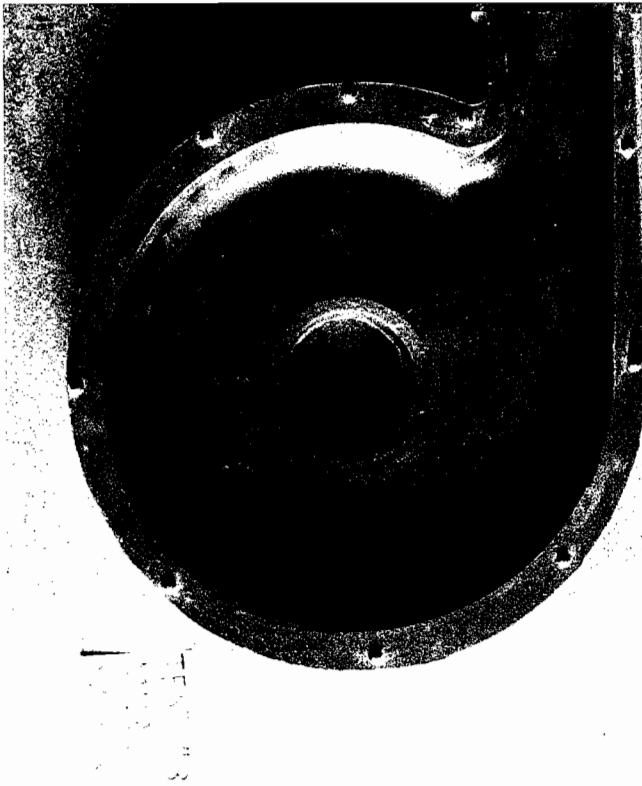

Figure 48. Natural Rubber Gland Side Liner After 200 Hr of Slurry Operation.

## DISCUSSION

The results of the experimental work clearly elucidate the effect of operating at partial capacities on localized wear in the pump and establish that various types of materials will have dramatically different wear rates under the same operating conditions.

The Ni hard pump tests yielded distinctive wear patterns which are typical for operation at partial capacity, and illustrate the dominance of recirculating streams at increasing wear rates. Virtually every part of the pump experienced a high degree of wear, especially the casing volute and suction side wear plate. The only area which did not show appreciable wear was the discharge nozzle. This is to be expected, since discharge velocities are half what they would be at design capacity, and the fluid stream which is recirculated at the discharge acts to further reduce mean particle velocities in this area.

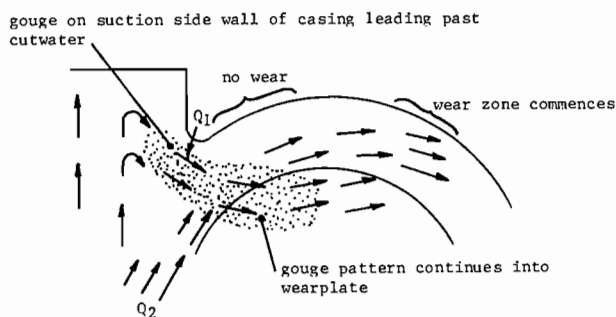

Figure 49. Influence of Merging Fluid Streams on Wear Pattern in Cutwater Area.

As the recirculating fluid stream from the discharge nozzle ( $Q_1$  in Figure 49) approaches the cutwater, it merges with the flow which is continuously ejected from the impeller vane passages ( $Q_2$ ). This fluid stream is also recirculated to some extent, because the cutwater is not 100 percent effective at channeling flow into the discharge nozzle. Slurry pump cutwaters are less effective than those for conventional process pumps, because of the rounded design. The net result of the two merging fluid streams is acceleration of the mixture past the cutwater through a restricted area. The cutwater itself is worn smooth, because of the very low angle sliding abrasion (Figure 15); however, considerable gouging occurs downstream to the casing and the lateral wear plates because of high particle velocities.

The greatest damage was done to the suction side wear plate (Figure 18), which is a stationary boundary exposed to high velocity particle impact. Similar gouging is not evident on the gland side of the casing because of the natural tendency of the mixture to be directed across the front shroud of the impeller toward the low pressure suction side of the casing (Figure 50). As the parts continue to wear, the axial clearance between the impeller and suction wear plate increases. The recirculated mixture forced into this gap is exposed to shear stresses caused by disk friction due to the front shroud and the pump out vanes. Slurry particles which would normally be expelled from this area become entrapped between the pockets formed by the pump out vanes and are forced to rotate at nearly the speed of the impeller, thereby abrading the surface of the stationary wearplate. If the head generated by the front pump out vanes is not sufficient to balance the ingestion of the mixture from the volute, the result is a net circulation across the wear plate in a spiral path towards the suction inlet (Figures 18 and 24). The urethane wear plate tests clearly illustrate this phenomenon, since the black sealer around the plate was smeared in a spiraling path towards the suction eye (Figures 32 and 37).

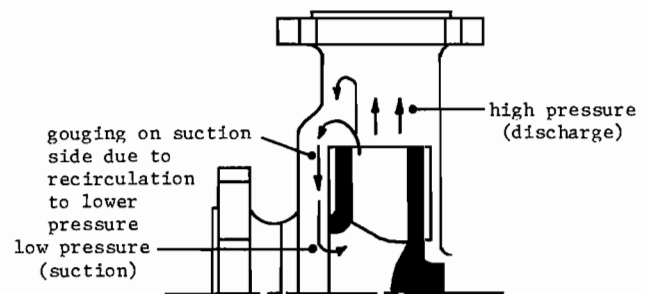

Figure 50. Recirculation Pattern between Suction Side Wear Plate and Impeller Front Shroud Due to Pressure Gradient.

As axial clearance increases, a greater amount of mixture passes between the front shroud and the wear plate, thereby accelerating the wear rate (Figure 51). The effect is severe abrasion to the inlet of the wear plate and the tips of anti-rotation vanes in the suction nozzle of the pump casing. The importance of adjusting the impeller front clearance at regular intervals cannot be overstressed if this wear is to be minimized.

Wear in the casing volute consists primarily of gouging abrasion which arises due to high velocity impact, and is amplified by low angle sliding wear. As the slurry progresses around the volute, pressure energy in the fluid is converted to kinetic energy which increases wear. The gouges become deeper as the discharge nozzle is approached (Figure 52). At one point approaching the discharge the wear gouges end

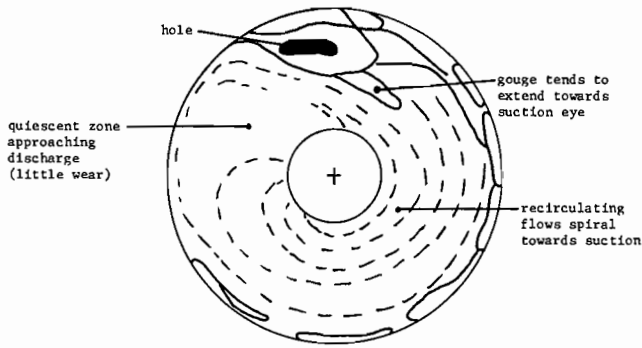

Figure 51. Spiral Wear Patterns on Suction Side Wear Plate Due to Slurry Recirculation.

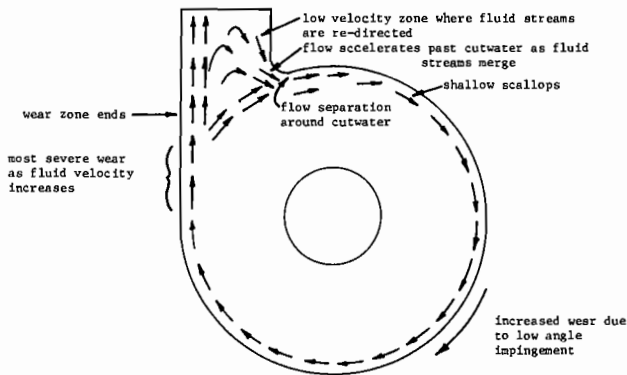

Figure 52. Wear Zones in Casing Volute at 50 Percent BEP.

quite abruptly (Figure 17). This point is essentially adjacent to the cutwater and casings, which have been allowed to wear to failure, hole first in this area.

A comparison of material volume loss versus operating time for the various wear plate materials tested is shown on Figure 53. Clearly, for the operating condition presented, the polyether base urethanes were superior to both the Ni hard and the polyester base urethane. The softest material yielded the best wear resistance in this case. The hardness of the first test material (95A) is beyond the normal range for slurry pump applications and may have compromised other important physical properties. It must be pointed out that although hardness has been used to characterize the urethane materials in this presentation, other physical properties also have a very profound effect on urethane wear resistance as they do for most materials.

The Ni hard wear plate provided very poor wear resistance and it is quite obvious that an elastomeric material is a better choice for this particular combination of slurry and pump operating conditions. The excellent results with the wear plates provided the impetus for a test series with a completely urethane liquid end.

The Ni hard and polyurethane pumps were tested for essentially the same period (437 hours versus 429 hours) of time, yet the urethane liners and impeller were in far better overall condition. Although the urethane suction liner was considerably more worn adjacent to the impeller front shroud (Figure 40) than would be expected from the previous wear plate tests, the reason may be due to increased front axial clearance and lack of pump out vanes on the prototype urethane impeller (Figure 43). The other areas of the liners, especially the volute channel, were in excellent condition, indicating that this material is very suitable for this application.

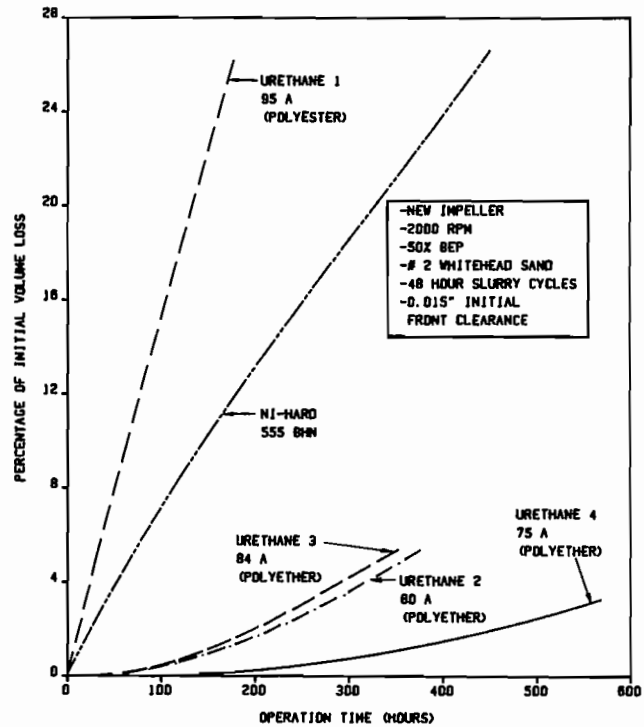

Figure 53. Comparison of Material Volume Loss for Various Suction Wear Plates Tested.

The rubber and neoprene tests were not done as part of the urethane test series and the data are included for completeness. This is why the operating speed and frequency of slurry changes for these materials is not the same. In fact, the severity of the rubber tests was not as great because the operating speed was 20 percent less.

It is interesting to note that the neoprene, even at slower operating speed, gave very poor wear resistance. It was determined that the neoprene suction liner lost 0.1 cubic inch of material per hour of service as opposed to 0.02 cubic inch per hour for the natural rubber. This clearly demonstrates neoprenes poor abrasion resistance in severe applications.

Although the rubber suction liner had not yet holed at 200 hours of operation, it was estimated that it would not last 300 hours before holing, even at the reduced speed. Initial particle size of the sand was slightly greater than for what rubber pumps would normally be recommended and the sand grains were quite sharp. Wear was, therefore, very rapid during the first few hours after a slurry change.

Although the wear resistance of the rubber is good, it does not approach that of the polyurethane pump for this particular test.

## SUMMARY

The data and discussions presented point out several considerations which should be carefully weighed when selecting slurry pumps.

Firstly, slurry pumps should be sized for efficient operation to match the conditions of service stipulated. Operation at partial capacities or over capacities can severely increase wear rates of liquid end parts, due to recirculation of the mixture. The test data presented are based on operation at 50 percent of BEP. Clearly the characteristic wear patterns and wear rates for the Ni hard tests demonstrate the effect of increased recirculation on localized wear, especially in the

cutwater area. These tests were conducted at reduced capacity and maximum rated speed (Figure 8), to accelerate wear rates for the purpose of comparative studies. Operation at condition points closer to BEP and at lower speed should significantly improve part life. As a general rule, operation below 50 percent of BEP is not recommended for severely abrasive applications. Closer operation to design capacity will also reduce radial and thrust loads on the impeller, which will improve the life of bearings, shafts and seals. Field studies clearly support this statement.

For applications where the output of the pump is regularly varied to meet transient demands of the system, it may be feasible to operate two smaller pumps in a parallel arrangement rather than one larger pump alone. In this case, one of the parallel pumps can be isolated at low flows, while the second pump alone continues to meet system demands close to the BEP.

The choice of abrasion resistant materials profoundly affects service life. In the cases presented, elastomeric materials provide superior resistance to wear. It must be understood, however, that no single material is a panacea for all abrasive environments. As particle size is decreased, natural rubber has distinct cost savings advantages. Hard metals are superior for coarser materials, where particle kinetic energy is in excess of that which can be absorbed by an elastomer. Polyurethanes may be used to bridge the gap in many instances offering good extensibility while maintaining high toughness.

It must be stressed that polyurethanes differ dramatically in physical properties and wear resistance. Materials of inferior quality can give very poor results in service. Material selection should be made on the basis of previous experience in slurry pumps and not on the results of simple bench top abrasion tests which can be misleading. It is necessary to test the material in situ to expose it to the various velocities, impingement angles and particle properties experienced in slurry pump service.

Several other considerations will improve pump life:

- the pump should have an axial adjustment feature and the adjustment should be made as required to reduce wear on the impeller and wear plate and to maintain best efficiency.
- pumpout vanes on the front and rear shrouds are valuable for improving part life and are desirable slurry pump features.
- a programmed rotation of suction and gland side wear plates will increase the useful service life of these parts.
- previous attrition studies have demonstrated the effectiveness of anti-rotation vanes at improving liquid end life.
- sufficient packing flush should be provided to reduce heat build up and wear on shaft sleeves. This will also purge the hub area of the impeller and reduce wear on the back shroud. Hydrodynamic seals (expellers) should be considered if flush dilution cannot be tolerated.

The final point to be made is that the pump manufacturer is the best source of related information about material selections for pump applications. This experience can be very beneficial to the user when selecting a slurry pump.

## REFERENCES

1. Fraser, W. H., "Recirculation in Centrifugal Pumps," Winter Annual Meeting of the ASME, Washington D.C. (1981).
2. Finnie, I., "Erosion of Surfaces by Solid Particles," *Wear*, 3, pp. 87-103 (1960).
3. Bitter, J. G. A., "A Study of Erosion Phenomena, Parts 1 and 2," *Wear*, 6, pp. 5, 169 (1963).
4. Neilson, J. H., and Gilchrist, A., "Erosion By a Stream of Solid Particles," *Wear*, 11, pp. 111-122 (1968).
5. Truscott, G. F., "A Literature Survey on Abrasive Wear in Hydraulic Machinery," *Wear*, 20, pp. 29-49 (1972).
6. Wilson, G., "The Design Aspects of Centrifugal Pumps for Abrasive Slurries," BHRA Second International Conference on the Hydraulic Transport of Solids in Pipes, paper H2 (1972).
7. Roco, M. C., Addie, G. R., Visintainer, R. J., and Ray, E. L., "Optimum Wearing High Efficiency Design of Phosphate Slurry Pumps," Proceedings of Eleventh International Conference on Slurry Technology, pp. 277-285 (1986).
8. Willis, D. J., and Truscott, G. F., "Solids-Handling Pumps—A Survey of Current Practice, Problems and Developments," BHRA Fifth International Conference on the Hydraulic Transport of Solids in Pipes, Paper F6 (1978).
9. Wiedenroth, W., "The Influence of Sand and Gravel on the Characteristics of Centrifugal Pumps, Some Aspects of Wear in Hydraulic Transportation Installations," BHRA First International Conference on the Hydraulic Transport of Solids in Pipes, Paper E1 (1970).
10. Sellgren, A., "Performance of a Centrifugal Pump When Pumping Ores and Industrial Minerals," BHRA Sixth International Conference on the Hydraulic Transport of Solids in Pipes, Paper G1 (1979).
11. Want, F. M., "Centrifugal Slurry Pump Wear—Plant Experience," BHRA Seventh International Conference on the Hydraulic Transport of Solids in Pipes, Paper H1 (1980).
12. Bergeron, P., and Dollfus, J., "The Influence of the Nature of the Pumped Mixture and Hydraulic Characteristics on the Design and Installation of Liquid/Solid Mixture Pumps," Proceedings of the Fifth Conference on Hydraulics, pp. 597-605 (1958).
13. Durman, R. W., and Elwell, D. W. J., "High Chromium Cast Irons in Pumps," *World Pumps*, pp. 354-356 (December 1985).
14. Shetty, D. K., Wright, I. G., and Stropki, J. T., "Slurry Erosion of WC-Co Cermets and Ceramics," *ASLE Transactions*, 28, (1), pp. 123-133 (1984).
15. Anon., "Tests Reveal Higher Speeds for Refrax® Ceramic Impellers," The Carborundum Company, Niagara Falls, N.Y.
16. Stepanoff, A. J., *Centrifugal and Axial Flow Pumps*, John Wiley and Sons, Incorporated, Second Edition, (1957).