

A NEW METHOD FOR SECONDARY CONTAINMENT OF EMISSIONS FROM PRIMARY SEALS

by

Allan Mathis

Maintenance Manager

Rohm and Haas Company

Deer Park, Texas

Joseph L. Melancon

Reliability Engineer

Lyondell Polymers

Pasadena, Texas

and

Fred Trackwell

Director of Product Development

A&A Environmental Seals, Inc.

LaMarque, Texas

Allan Mathis is the Maintenance Manager over the Acetylene and Utilities Department at Rohm and Haas, Deer Park, Texas. He oversees all maintenance work (routine and turnaround), purchasing, and mechanical engineering. His efforts are concentrated on increased reliability and mechanical integrity. Mr. Mathis has been with Rohm and Haas for three years. Previously, he held a variety of positions at

Amoco Oil Company, Texas City. The last seven years were concentrated in the area of rotating equipment. He held the position of rotating equipment supervisor handling all aspects of rotating equipment, including rotordynamics.

Mr. Mathis has a B.S. degree (Mechanical Engineering) from the University of Texas at Arlington. He has also authored papers in the area of vibration analysis and rotordynamics.

Joseph L. (Joe) Melancon is a Principal Reliability Engineer with Lyondell Petrochemical Corporation's Bayport Polymers Plant, in Pasadena, Texas. His past assignments have included petrochemical industry maintenance and reliability, offshore oil and gas industry maintenance, and project positions. He has been responsible for the installation and repair of process equipment, the

investigation of process equipment problems, the recommendation and implementation of corrective actions to enhance equipment and overall plant reliability, and the review and creation of maintenance policies and procedures.

Mr. Melancon received a B.S. degree (Mechanical Engineering) from the University of Southwestern Louisiana (1982). He copresented a short course at the Twelfth International Pump Users Symposium and was chairman of the coordination committee for the 1994 ASME South Texas Section Centrifugal Pump Engineering Seminar. He is a registered Professional Engineer in the States of Texas and Louisiana and a member of ASME, Tau Beta Pi, and Pi Tau Sigma.

Fred Trackwell is currently Director of Product Development for A&A Environmental Seals, Incorporated, part of the A&A Group, in LaMarque, Texas. His responsibilities include overseeing product research and development and custom product design of the seal-assist system. He also assists in product marketing and provides technical field support to A&A client companies.

Mr. Trackwell was introduced to the fluid sealing industry in 1991 and began his research and development of the seal-assist system in 1993. His design was awarded a patent in 1996 and he currently has several patents pending. His affiliations include TAPPI, Pacific Energy Association, and IMI.

ABSTRACT

Recent industrial advances in secondary containment methods have increased the role of secondary containment systems in environmental corporate strategies aimed at lowering the risks associated with leakage from primary sealing systems. As a result, secondary containment has become the primary method for achieving zero emissions in many sealing applications. The seal-assist system (SAS), incorporating a patented entrainment system, is one of the secondary containment advances that has proven its ability to achieve zero emissions in a variety of both rotary and reciprocating applications. A description of the entrainment system, its potential uses, and two plant studies are presented. Both plant histories discuss the economic, environmental, and safety benefits achieved from utilizing the seal-assist system in various hazardous and volatile organic compound applications.

INTRODUCTION

As a result of environmental regulations, refineries and other chemical processing facilities are implementing new programs aimed at lowering plant emissions. Most plant emission reduction programs focus on historically high emission sources such as shaft seals on pumps, valves, and compressors. Recently, the emphasis on achieving zero emissions in rotary applications has led end users to experiment with new dry-running and noncontacting mechanical face seals as secondary containment systems for

existing primary seals. In reciprocating applications, rod packing relies mainly on secondary purges or high pressure buffer gases to ensure emission containment.

In today's market, new shaft seal technology that simply increases equipment reliability without offering other environmental or economic benefits no longer provides sufficient incentive for most end users to upgrade their existing seals. The new seal-assist system (SAS), a unique secondary containment method that achieves zero emissions in a variety of primary seal applications, offers end users features and benefits unavailable with other conventional secondary sealing methods. One benefit of the SAS, due to its unconventional operating system, offers end users the option to easily recover process seal emissions to include liquids and powders. The SAS operating system provides end users with an alternative method of sealing various severe sealing applications such as dry powders, hot acids, and slurries.

Two plant studies are presented—Rohm & Haas, Deer Park Plant and Lyondell Polymers, Bayport Plant.

THE COANDA EFFECT

The coanda effect plays a very significant role in the SAS operating system.

The description in 1932 by Henri Coanda of what is now known as the coanda effect is of major importance to the Technology (Fluidics). He observed that as a free jet emerges from a jet nozzle the stream will tend to follow a nearby curved or inclined surface and will even "attach" itself to, or come into contact with and flow along this surface if the curvature or angle of inclination is not too sharp. (Figure 1 illustrates this effect.) The explanation of this tendency lies in the fact that the jet stream "entrains" or picks up nearby fluid molecules. When the supply of these molecules is limited by an adjacent surface, a partial vacuum develops between the jet and the surface. If the pressure on the other side of the jet remains constant, the partial vacuum which is a lower pressure region, will force the jet to bend and attach itself to the wall (Humphrey and Taramoto, 1968).

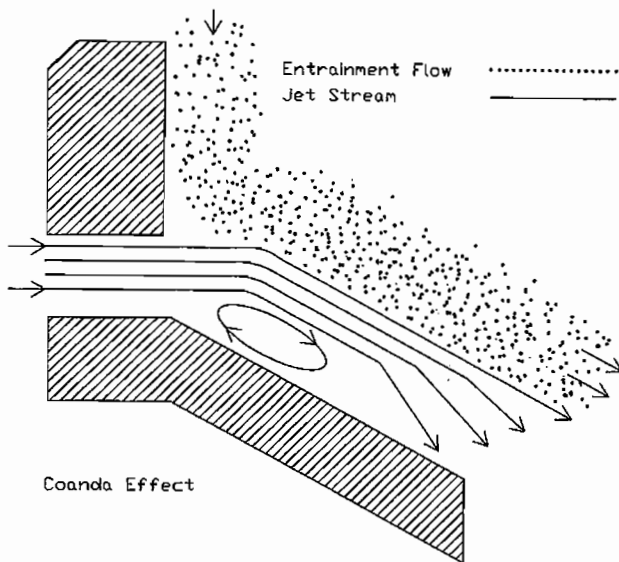

Figure 1. Coanda Effect.

The coanda effect is a general term used to describe turbulent boundary layer fluid flow over a curved or inclined surface (Figure 2). The surface adherence phenomenon of the coanda effect is used in various industrial applications. In the SAS, the coanda effect is used to entrain emissions (secondary fluids) from a primary seal and deliver the entrained emissions to a specified control device or system. For this paper:

- *Primary fluid* is defined as the compressible fluid used to create the coanda effect.
- *Secondary fluid* is defined as any fluid, normally primary seal emissions, in close proximity to the coanda effect region, not a part of the primary fluid.
- *Amplification ratio* is defined as the total volume of discharged fluid from a coanda system, as compared with the primary fluid used to create the effect.

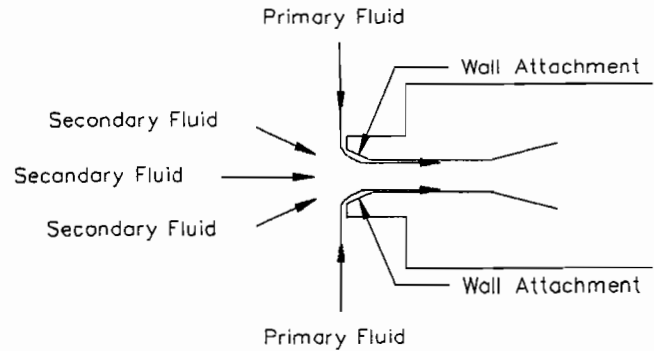

Figure 2. SAS Use of the Coanda Effect.

One of the benefits of the coanda effect is the amplification of the discharge flow as compared with traditional eduction methods under similar operating conditions. Some coanda based systems advertise discharge amplification ratios as high as 30 to 1.

When used in the SAS, the coanda effect's amplification ratio creates a highly efficient method of capturing and transferring primary seal emissions to a specified recovery or disposal system.

SEAL-ASSIST SYSTEM

Theory of Operation

The SAS is a secondary containment system that utilizes the fluid entrainment principle of the coanda effect to capture and deliver emissions from a primary seal to a control point such as a flare header or vapor recovery system. This is accomplished in the SAS by recycling a portion of the discharge fluid created by the coanda effect back through the low pressure side of the system. A transfer of momentum takes place between the static incompressible fluid and the dynamic fluid of the system creating flow of the incompressible fluid in the direction of flow of the dynamic fluid (Figure 3).

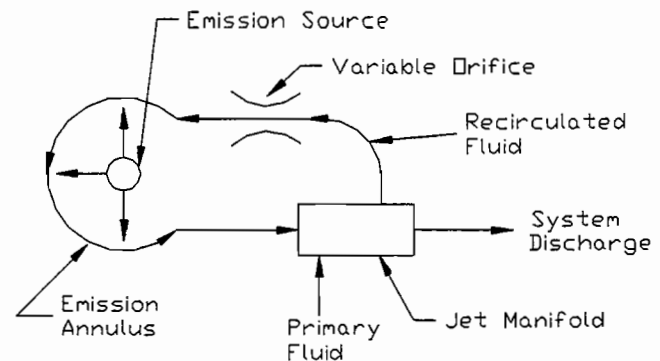

Figure 3. SAS Basic Flow Diagram.

Thermal Effects

The thermal effects of this type of produced fluid flow vary with the primary fluid used to create the coanda effect. The SAS is limited to the use of a compressed gas for its primary fluid.

Nitrogen, steam, and air are the gases most widely used by end users as the primary fluid, but any compressible gas will operate the system. The primary fluid temperature used in the SAS can control to some extent the primary seal, and to a greater extent, the emission fluid temperature. An example of this would be if an end user wished to control a phase change of a seal emission (liquid to vapor, liquid to solid, or vapor to liquid). Taking into consideration the normal operating pressure of the SAS, an end user could prevent or cause a phase change of a primary seal's emission for easier entrainment into the system by using a hot or a cold primary fluid.

Emission Isolation

To achieve its objectives, the SAS is comprised of three basic elements:

- Emission isolation
- Fluid flow creation through the coanda effect
- Fluid recycling

In order to successfully operate, the SAS must first isolate the emission source from potential sources of contamination such as atmosphere. Once the emission source is isolated, a device capable of producing the coanda effect is attached near the emission source. Gas and vapor emissions (the surrounding secondary fluids as described above) entering the system will tend to move toward the low pressure region created by the coanda effect. Through the transfer of momentum of the primary fluid, the entrained emissions are repressurized and pumped to an appropriate control device or emission recovery system. Under normal operating conditions, the coanda effect's low pressure region is usually less than atmospheric pressure. Emission isolation is achieved through the use of either:

- A secondary seal gland, known as an emission containment gland or ECG, that is attached to an existing primary seal gland, or
- The use of a single seal gland that combines the required components of both the primary seal along with the basic components of the ECG (Figure 4).

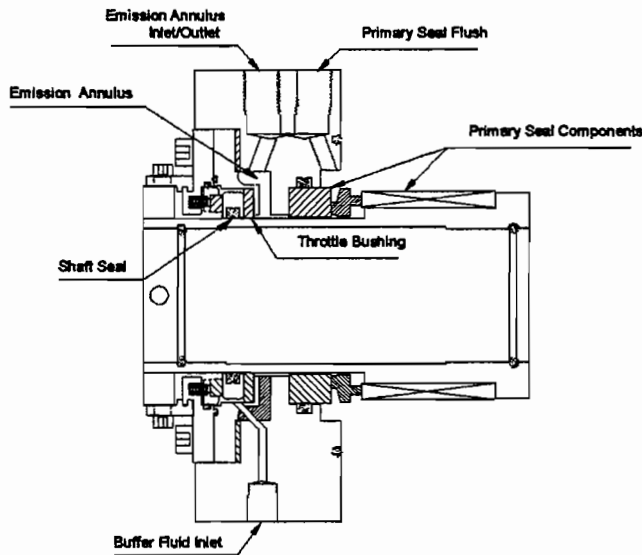

Figure 4. Single Unit Gland.

The type of seal gland used in a particular application depends on the available installation space, the customer's preference, and the existing primary seal type. The major components of the ECG (Figure 5) are:

- An emission annulus—defined as an arched channel of less than 360 degrees around a rod or shaft connected on either end by an inlet and outlet channel;

- A throttle bushing;
- A shaft or rod seal.

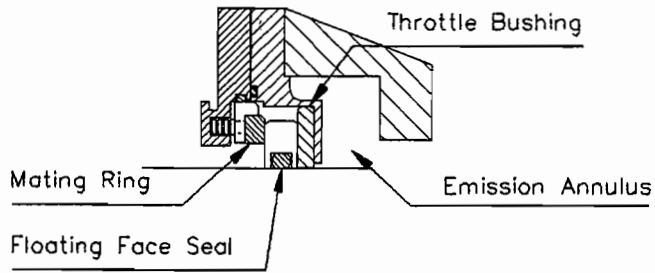

Figure 5. ECG Major Components

The emission annulus of the ECG creates an arched channel around the rod or shaft, isolating for most shaft seals, the primary source of seal emissions. Emission isolation is further achieved through the use of a close tolerance throttle bushing positioned just past the emission annulus. The throttle bushing is also used to assist in the alignment of the ECG to the shaft or rod. The last major component of an ECG system is the shaft or rod seal. There are only a few restrictions on what type of shaft seal can be used in a particular application, and these restrictions are normally related to space availability. Also considered in the shaft seal selection are the application's process and operating conditions. Further details on the function of the throttle bushing and the shaft seal in the SAS will be explained later.

The Emission Annulus

The device used in the SAS to create the coanda effect is the jet manifold (Figure 6). The emission annulus is attached at either end by an inlet and outlet channel. The outlet channel is further connected to the low pressure side of the jet manifold. The inlet channel of the emission annulus is connected to the high pressure side of the jet manifold. The SAS design incorporates a recycle loop that serves two purposes:

- To control the negative pressure created by the system in the area of the primary seal. The operating pressure in the emission annulus can be controlled by varying the volume of flow of the recycled fluid. For most systems, the suggested operating pressure is -2 to -4 in of water column.
- To entrain, control, and recover liquids or solids entering the emission annulus. The recycled fluid, through an exchange of kinetic energy, carries liquid or solid emissions away from the primary seal and into the jet manifold for further processing.

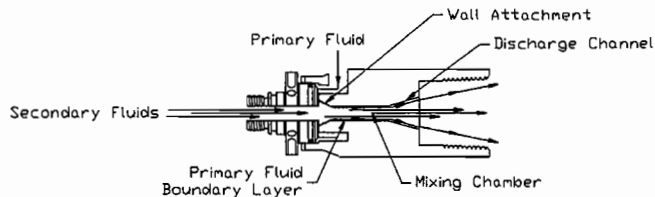

Figure 6. Jet Manifold Control Wheel and Body Assembly.

A variable orifice is installed between the inlet channel of the ECG and the high pressure side of the jet manifold to control the volume of recycled fluid through the SAS. Due to the restriction in flow, a pressure differential is created between the high and the low pressure side of the jet manifold. The geometry of the emission annulus causes the fluid flow, usually at very high velocity, to sweep through the annulus in one direction. Single directional flow through the emission annulus aids in the entrainment of liquids and powders entering the system.

The Floating Face Seal—The Atmospheric Barrier

In conventional sealing systems, the shaft or rod seal is the primary method of emission containment. Through physical contact, conventional sealing systems prevent process leakage from escaping to the seal's surrounding environment. Due to continuous physical contact, normally in continuous motion operating under both pressure and thermal stress, conventional shaft seals have a predictable, reliable, operating life. In contrast, the fluid flow through the emission annulus is the primary source of containment in the SAS. Since the normal operating pressure of the emission annulus is less than atmospheric, the SAS shaft seal spends most of its operating life under little or no pressure. The primary role of the SAS shaft seal is to prevent fluid flow from outside the isolated system from entering into the emission annulus.

For rotary applications, the preferred shaft seal design is the floating face seal (FFS) (Figure 7). The FFS is an O-ring driven seal normally constructed of silicon carbide and lapped to optical flat on both faces. The FFS is installed into a chamber of the ECG. The chamber is designed to create a close tolerance fit on both faces of the FFS. The FFS chamber allows the FFS to float with radial movement of the shaft up to .080 in total indicated runout. To further assist the FFS in its role as an atmospheric barrier, a low pressure buffer fluid is injected into the FFS chamber.

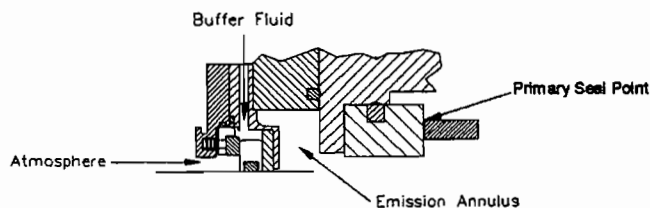

Figure 7. Floating Face Seal Description.

For gas and vapor primary emissions applications, a noncontacting FFS with a low pressure buffer fluid can be used successfully. For liquids and powders, the use of a light face load of the FFS is preferred. The sealing principle of the FFS is similar to that of traditional mechanical face seals, while the operating principle is not similar. Due to its atmospheric operating pressure, normal seal evaluation methods such as PV ratings and balance ratios are of little value in determining successful operating conditions and life expectancy of the FFS. Under normal operating conditions the life expectancy of the FFS is indefinite. Under a primary seal upset condition, either a partial or complete failure, the FFS is designed to increase face contact with its stationary element as pressure increases in the emission annulus to prevent process leakage to the atmosphere. This allows end users time to safely shut down the process equipment, schedule required seal repair, and additional equipment maintenance.

The Jet Manifold

In the SAS, the coanda effect is produced through a specially designed nozzle system. A primary fluid under pressure is forced through a gap created by an adjustable orifice. A turbulent boundary layer of primary fluid is produced around the interior cylindrical walls of the jet manifold. The primary exchange of kinetic energy of the primary fluid to the secondary fluid takes place in the jet manifold. As fluid exits the jet manifold, it loses some of its velocity and regains some of the primary fluid's initial pressure. Once the coanda effect is produced, as long as the flow of the primary fluid and the control device system operating pressure remain constant, the entrainment, recompression, and discharge of emissions to the control device will continue to occur.

The size of the jet manifold will vary with the type of emissions, the required discharge pressure of the jet, and the limit for the consumption rate of the primary fluid under the specified operating

conditions of the end user. Incompressible fluids require higher mass flow rates through the recycle line than do compressible fluids. This limits the maximum discharge pressure a given jet manifold can produce when entraining incompressible flows. Figure 8 shows the relationship between primary fluid pressure, primary fluid consumption, and maximum discharge pressure for the different jets.

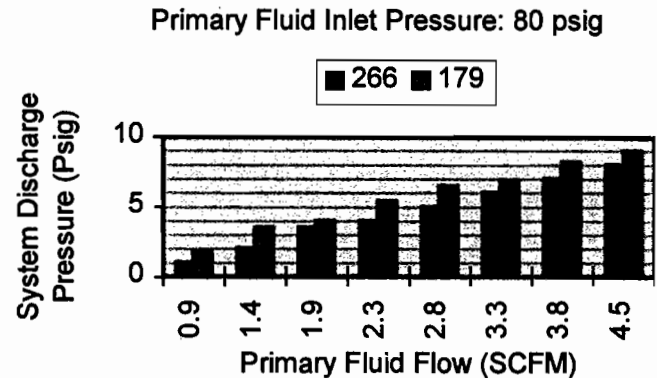

Figure 8. Jet Manifold Sizing Chart.

The SAS Compared to Other Secondary Containment Systems

The SAS is distinctly different from typical secondary sealing systems. Traditional secondary sealing systems in rotary applications normally require a pressurized barrier fluid, gas, or liquid between two specially designed mechanical face seals. The barrier fluid is injected between the two mechanical seals under sufficient pressure to ensure that the process fluid being contained will not flow into the barrier seal chamber through the primary, or process, seal of the system. This usually requires a barrier pressure of 20 to 30 psig over the process pressure being sealed. It usually requires a small percentage of the barrier fluid to flow into the process being sealed. In many cases, this is not a desirable condition. Process contamination is one of the major drawbacks with this type of secondary containment. The barrier fluid injected into the process stream must be accounted for at some point in the production process. For many chemical processes, contamination of any kind cannot be tolerated. Conversely, the SAS operating principle of emission entrainment outside the primary seal ensures end users there will be no process contamination at the point of the emission source. Additionally, since the SAS operates with a compressed gas, end users gain some of the benefits of conventional gas seal technology without the required process contamination. Some of the benefits of this type of system are:

- The low operating pressure of the SAS eliminates the possibility of barrier fluid contamination of the process and reduces the stress on its secondary seals in the ECG (O-rings, shaft seals, and gaskets).
- Because the SAS creates a fluid flow through its emission annulus, the system can be used to control most types of fugitive emissions including gases, vapors, liquids, and powders.
- The fluid entrainment principle of the system can be applied in both rotary and reciprocating applications, at most process temperatures, and without loss in containment efficiency.
- The primary seal, process fluid, and emission temperature can be controlled by adjusting the temperature or type of primary fluid (motive gas) used to create the coanda effect in the jet manifold.

Emission Recovery or Disposal

Because of the unique operating principle of the SAS, end users have several options regarding the recovery or disposal of captured emissions. The SAS is a capture and delivery system. The limiting capacity of the SAS is based on two factors:

- The size of the nozzle used in the jet manifold,
- The required discharge pressure of the SAS.

The SAS emission containment capacity far exceeds that which would be expected to escape from two flat seal faces in close proximity to each other. Fern and Nau (1976) quantified the leakage (Q) between two flat surfaces in close proximity with the following equation:

$$Q = 10^{-10} \times 6\pi r c^3 p / \eta \omega \text{ ml/h,} \quad (1)$$

Where:

- c = clearance between the two surfaces in μm
- η = the dynamic viscosity in N s/m^2
- r = the mean radius in m
- ω = width of the face in m
- p = pressure across the seal in N/m^2

Fern and Nau (1976) go on to write:

Clearly, if the value of c is doubled then Q will increase eightfold. In practice it has been discovered that the value of c is usually in the range 1-5 μm and the leakage rate is of the order of 1 ml/h, a value which depends very much on the operating conditions.

The minimum emission capacity of the smallest nozzle used in a jet manifold is 500,000 times greater than the estimated average mechanical seal leakage of 1 ml/h.

In order to use a pressurized control device or recovery system with the SAS, the following operating conditions must exist:

- The primary fluid of the SAS must be compatible with the recovery or control process.
- The normal operating pressure of the recovery or control system must not exceed the maximum discharge of the jet manifold.
- The recovery or control system must be in operation while the SAS is in operation.
- The distance from the jet manifold to the entry point of the recovery or control system must not exceed the maximum discharge distance of the jet manifold for the emission type being controlled.

Currently, the most common disposal system used with installed SASs are plant flare systems. Most flare system headers are easily accessible throughout a plant operating continuously at low pressure. For SAS users with recovery devices that meet the required operating conditions, capturing and recovering primary seal emissions can be beneficial. An example of this type of production yield increase was experienced by an SAS user in a compressor application. The process gas of the compressor is the primary fluid used in this application. Emissions from the rod packing of the compressor are recycled back to the suction drum of the compressor. The additional operating cost for the SAS to the end user is the negligible horsepower consumption used to compress additional primary fluid for the jet manifold. In addition to achieving zero emissions, the increase in the production of the compressor paid for the initial cost of the SAS in five weeks. Additional systems were then installed on each compressor in the process unit to further increase production.

When liquid is the primary emission being contained, the SAS can deliver the liquid to a knockout drum. The primary gas and the entrained liquid emissions can be separated in the knockout drum. The primary gas can be vented to atmosphere, when appropriate, or sent to a recovery or disposal device. Once in the drum, the liquid emission is easily recovered, usually directly back to the original process.

Field Tested

Since its introduction, the SAS has been successfully applied in some very severe applications. From dry powder applications to

high speed reciprocating compressors, the SAS has proven to be a cost effective, long term solution to a wide range of difficult sealing challenges. Table 1 is a partial list of successful SAS applications.

Table 1. Partial List of Successful SAS Applications.

Type of Equipment	Service	Primary Seal	Shaft Speed (RPM)	Type of Emission	Months of Service
Horizontal pump	Caustic	Packing	1750	Liquid	27
Screw feeder	HDPE powder	MECO seal	60	Powder & gas	24
API pump	Acetylene/Water	Packing	3600	Liquid	18
API pump	Ethylene	Mechanical seal	3600	Gas	10
Reciprocating compressor	Vinyl chloride	Compressor packing	770	Vapor	9
Reciprocating compressor	SO ₂	Compressor packing	960	Vapor & liquid	9
Blower	Toxic gas	Packing	1750	Vapor & liquid	6

PLANT HISTORY #1

High purity acetylene is produced and supplied to our customer as feed stock. Due to the extremely high explosion risk posed by acetylene, plant personnel are very concerned when changes are made to the unit, especially if those changes involve process pump seals and compressors.

When the unit's maintenance personnel began studying the SAS as a possible solution to various sealing challenges in the unit, the first question to be answered was, could the technology be applied safely and effectively? The applications being considered for use with the SAS ranked in explosion risk from very low to extremely high. A team of customer company personnel was formed to evaluate the coanda system. It was decided the system should be tested in a low risk application that historically had been difficult to seal by conventional means.

The test applications selected were three multistage, vertical U.S. pumps operating as cold quench pumps in the unit's burner cooling system (Table 2). The three pumps had a history of chronic sealing problems. As with most high speed vertical pump applications, shaft whip is a major concern. The cold quench pumps circulate acetylene entrained water, in combination with soot product, resulting in rotor imbalance. The acetylene plates out of the water as it evaporates. One of the main issues with sealing this type of medium is to make sure the seal remains cool. Heat and acetylene can cause an explosion. The combination of rotor imbalance and acetylene entrained water has proven to be a very challenging sealing application.

Table 2. Pump Operating Conditions.

Pump	Discharge Pressure (PSIG)	Temperature	GPM	Number of Stages	Motor RPM
1	60	ambient	320	2	3600
2	60	ambient	320	2	3600
3	80	ambient	1800	4	3600

Over the years, various types of compression packing have been tested in these applications with poor results. Compression packing, although more reliable, creates other health and safety hazards, due to its high liquid leakage rate producing a large spray pattern around the pumps. Three custom packing assist systems (PAS) were installed on the pumps over a three month period starting in April 1996.

The SAS is normally the secondary seal in a double seal system. The PAS variation of the SAS is formed by combining a SAS with a custom designed packing follower/packed cartridge housing system as the primary seal (Figure 9). The PAS is designed to ensure all leakage, along both the inside and outside diameter of

the packing, is directed to the arced channel of the ECG where it can then be captured and processed.

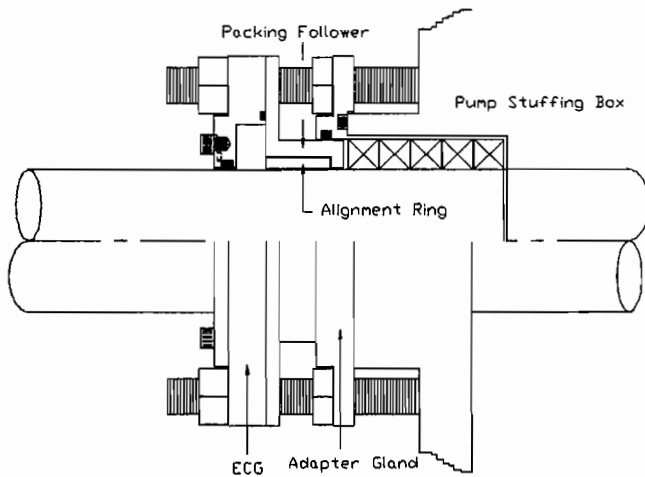

Figure 9. Typical Packing Assist System (PAS).

Initial shaft alignment is especially important in vertical pump applications. Misalignment during the initial installation of PAS will magnify the shaft whip associated with these pumps. For ease of installation and to eliminate a potential hazard, the PAS achieves initial shaft alignment through the use of a close tolerance carbon bushing incorporated into the packing follower. The carbon bushing aligns the entire system, including the packing, to the shaft. In addition, the alignment of the packing to the shaft reduces the initial heat generated at startup of the pump. The allowable shaft run out for a standard PAS is 0.080 in TIR.

The installation for each pump was identical. Each pump had a dedicated PAS with a 266 jet manifold operating off the unit's instrument air header (header pressure: 80 psig). Each jet was piped to discharge into the suction of the pumps at atmospheric pressure. The installation for each pump went smoothly. After startup of Pump #3 (Figure 10), a minor modification had to be made to the packed cartridge housing due to leakage from its gland gasket area. The gasket leakage was a result of low gland bolt torque. The bolt pattern of the pump's stuffing box is two studs 180 degrees apart. After startup, leakage occurred in two places, 90 degrees from each stud. The problem was corrected by adding two additional studs to the pump's stuffing box, creating four equally spaced studs. The additional bolting torque allowed the face gasket to seal.

Each pump was monitored closely for several weeks after startup. Due to continued operating success of the system, the monitoring schedule was relaxed to once a week, then occasionally each month.

The PAS functions like a traditional packing follower system. End users have the ability to adjust the packing as required by tightening the packing follower of the PAS. Unit maintenance personnel did not feel the need to adjust the PAS on two of the pumps during the first year of operation. The third pump had one minor adjustment due to icing of the seal.

The pumps were shut down after one year of continuous operation and the PAS evaluated. The results of the evaluation (1997 annual outage) determined that we could have run considerably longer, even to the next annual outage (Figure 11). Even though past history had shown that the cold quench pumps required continuous upkeep, we now visually inspect the pumps every couple of months, with plans to overhaul the pumps in two years. At that time, we will evaluate the need to move the overhauls out another year.

Due to the successful test applications, four additional PAS systems were installed on two Nash compressors (Figures 12 and 13). The compressors transport acetylene gas to the customer.

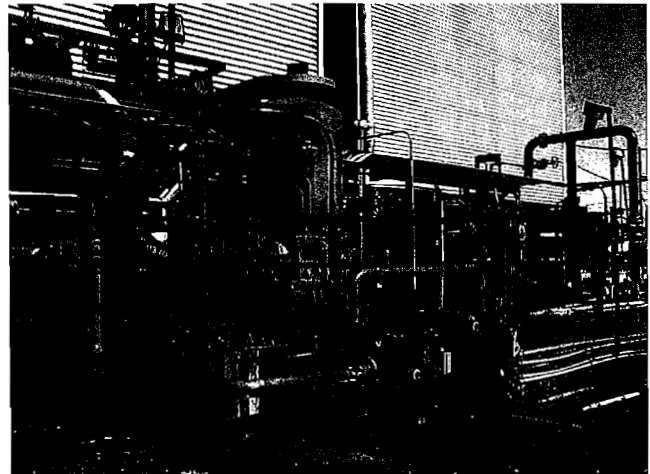

Figure 10. Pump #3—Four Stage Vertical Pump with PAS Installed.



Figure 11. PAS Coated in Soot, but Leak Free after 18 Months in Service.

Although the function of the PAS in the Nash application is similar to the cold quench pumps, the explosion risk in the compressor application is very real. The compressors are liquid ring compressors that utilize water to help transport the acetylene to the customer. The water is immediately knocked out once it leaves the discharge nozzle. Industry wide, the Nash compressors are being retrofitted with mechanical seals. The authors have determined that the PAS system can be installed considerably cheaper than mechanical seals and still have the confidence that the acetylene gas will remain cool.

Conclusion

The SASs now operating in the unit have met or exceeded the expectations of the customer. The systems installed to date have an estimated 12 month payback based on their test performance.

The SASs have reduced maintenance cost in the unit, \$13,622 per year and over \$2,000 in inventoried spare parts (Table 3). Additionally, the systems have increased worker safety by eliminating several slip-and-fall hazards created by the previous sealing systems.

PLANT HISTORY #2

The plant for this history is divided into two units, low density polyethylene (LDPE) and polypropylene. The LDPE unit has



Figure 12. Nash Compressors (Before PAS Was Installed).



Figure 13. Nash Compressors (After PAS Was Installed).

Table 3. PAS Cost Comparison.

Cost Item	Previous Sealing System	PAS System
Repair parts/pump/yr	\$ 600	\$250
Maintenance man hours/pump/yr	\$4,128	\$344
Support man hours/pump/yr	\$ 360	\$ 30
Primary fluid cost/pump/yr	0	\$197
Total Yearly Cost/Pump	\$5,088	\$821

various API pumps operating in high pressure ethylene service. The emission monitoring of VOC pumps in the unit is done on a quarterly basis by an outside contractor. The contractor uses EPA approved standards for emission testing and reports the results to the appropriate personnel.

To improve the MTBF of four API Krogh vertical pumps, P-2601A and B reflux, and P-2603A and B product pumps, a project was initiated to upgrade the current sealing system. These pumps are part of the process involving the unit's ethylene purification column. The discharge pressures of the pumps range from 380 psig to over 400 psig with an ethylene process temperature of -12°F.

The primary seal installed in each pump is a single, balanced pusher type mechanical face seal. The face combination specified for this application is a silicon carbide stationary block seat

running against a carbon rotary. For additional emission containment, 1/2 cfm of nitrogen is swept through the purge area of the seal gland and sent to the flare header. The repair history of the pumps indicated repairs to the pumps were made on a quarterly basis, even for those pumps not in service. The average annual cost to operate and repair each of the current single seal systems is shown in Table 4.

Table 4. Cost Comparison.

Cost Item	Previous Sealing System	SAS System/Primary Seal
Repair parts/pump/yr	\$3,200	\$ 650
Maintenance man hours/pump/yr	\$3,440	\$ 344
Support man hours/pump/yr	\$ 600	\$ 60
Primary fluid cost/pump/yr	\$ 183	\$ 275
Total Yearly Cost/Pump	\$7,423	\$1,329

The cost to operate and maintain the four pumps averaged approximately \$29,692 per year. For both economic and environmental reasons, maintenance personnel began evaluating available double seal and secondary containment systems that would reduce the high cost of maintenance of the pumps. The evaluation team was reluctant to install a traditional double seal system with liquid barrier fluid, due to barrier fluid compatibility concerns and potentially high maintenance requirements. With traditional double and tandem seals eliminated as an option, the team's focus shifted to evaluating the available new gas seal technologies. Each gas seal was evaluated on the following criteria:

- Ease of installation
- Support system required for operation
- Repair and maintenance costs
- Operating principle of the system
- Impact of the system on the process
- Environmental benefit of the seal

The recommendation of the team was to test an SAS for the following reasons:

- The current single seal could remain as the primary seal for the SAS—The single pusher seals operated well in the application, but required a secondary containment system to control low level leakage of ethylene to atmosphere. The SAS could be installed in tandem with the existing seal gland without modifying the pump or the existing seal gland. A test of the new secondary containment system could be achieved without experimenting with a new primary seal in the application.
- The evaluation team considered the test of the SAS, a backup to the exiting primary seal, a low risk project—Because the primary seal technology of the pumps would not be changed and the SASs operating principle of emission entrainment posed little threat to damaging the primary seal, the evaluation team rated the SAS as the lowest risk factor of the available options.
- The jet manifold could operate off the existing nitrogen header (100 psig) in the area—Other gas seal systems considered required the installation of a special high pressure barrier gas system and control panel. To install the SAS required limited additional piping. Nitrogen lines were already in place at each pump (the nitrogen purge lines to the existing seal glands).
- The available control system, the units flare header, and pressure (2 to 5 psig) were within the operating range of the SASs jet manifold.
- Based on the application, the control system's operating parameters and the operating principle of the SAS, the evaluation team believed the SAS would achieve the minimum requirements of their project objective of reducing maintenance cost and extending MTBF.

On November 5, 1996, the first SAS was installed on the unit's reflux pump P- #2601B (Figure 14). It was decided not to replace or repair the test pump's primary seal. This would serve to better evaluate the emission control capabilities of the SAS. The pump went through its normal installation and startup procedures. The SAS was monitored by plant personnel for emissions. All readings recorded *zero emissions* to atmosphere. The installation and startup of the system were a complete success.

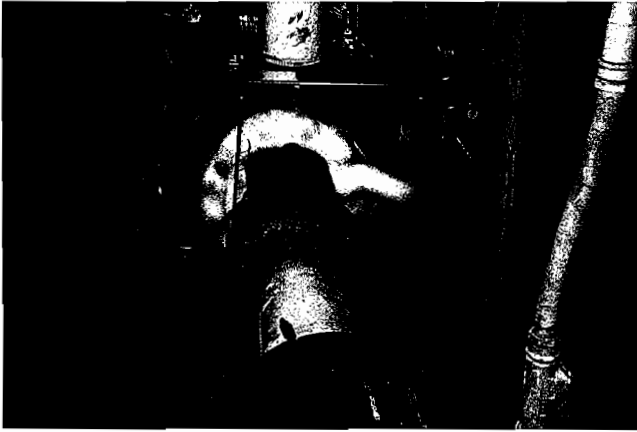

Figure 14. Reflux Pump with SAS Installed.

After two months of operation, the operators of the unit reported ice was forming on the discharge line of the jet manifold. This indicated primary seal emissions had dramatically increased but were still being contained by the SAS. The discharge pressure of the SAS, normally at 5 psig for this application, had risen to nearly 10 psig. A check of the flare header conditions revealed no unusual activity. The source of the pressure buildup has to be leakage from the primary seal. Emission check on the SAS still reported zero emissions and the pump was operating normally.

Although the discharge pressure of the system eventually reached 40 psig, daily emission monitoring of the SAS remained at zero ppm without any adjustment made to the system. On January 6, 16 days after the first report of ice buildup on the discharge line of the jet manifold, the spare reflux pump was started and the primary reflux pump was shut down for repair on a planned pump outage. It was revealed during the failure analysis of the primary seal that the ethylene leakage was due to a rupture in one of the mechanical seal's static O-rings.

Both the mechanical seal and SAS were repaired and reinstalled on the pump. The only repair to the SAS was the replacement of the driver O-ring of the FFS. The pump was installed and restarted. Continuing emission monitoring of the pump has yet to reveal any emission from its SAS or primary seal system.

CONCLUSION

The performance of the SAS, especially during the primary seal's upset condition, proved the system's value to the unit. With its added economic and safety benefits, more application of this technology is now being considered on a plant-wide basis.

SUMMARY

Zero emissions can be achieved through the use of the coanda effect. The Plant History #1 facility is saving in excess of \$15,000 per year by using the SAS to capture emissions from acetylene pumps. The Plant History #2 facility is saving over \$30,000 per year using the SAS to capture emissions from ethylene reflux and process pumps (Figure 15).

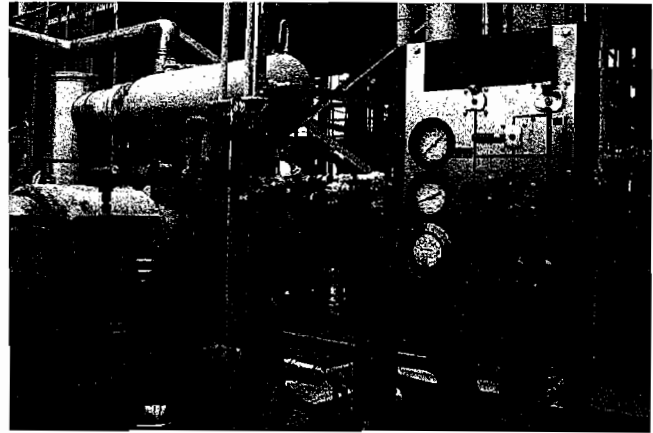

Figure 15. Reciprocating Compressor with SAS Secondary Containment System and Control Panel.

The SAS system is successfully being used to capture emissions from packing or mechanical seals in a variety of pumps, valves, and compressors. The units are easily installed, reduce maintenance, and have been proven to extend the useful life of the primary seal. Although the system has proven to have tremendous beneficial environmental impact in many applications, it is the economic and safety benefits that will ultimately drive the technology to further development and industry-wide use.

REFERENCES

- Fern, A. G. and Nau, B. S., 1976, *Seals*, Oxford University Press.
 Humphrey, E. F. and Tarumoto, D. H., Editors, 1968, *Fluidics*, Revised Edition, Fluid Amplifier Associates, Incorporated.

BIBLIOGRAPHY

- Schlichting, H., *Boundary-Layer Theory*, Seventh Edition, New York, New York: McGraw-Hill Book Company.
 Seal-Assist System, U.S. Patent #5,516,119 and patent pending.

ACKNOWLEDGEMENTS

The authors would like to acknowledge the following Lyondell and Rohm and Haas employees, without whose help and support, this technology would not have been tested at their facilities. At Lyondell: Larry Drake, who discovered the seal-assist system technology during his evaluation of alternative sealing technologies for the ethylene pumps; Debbie Kryak, Denny Wiseman, and Allen Valenta, for supporting the authors' efforts to test the technology; and the entire Lyondell Bayport Maintenance Department and PE Unit Operators for successfully installing and operating the new technology. At Rohm and Haas: Mike Warth for his leadership and encouragement to try new ideas and his willingness to take the extra step; and Tuan Hoang and Mike Pitman for their efforts in moving toward a proactive maintenance organization while looking for new and innovative ideas to improve equipment reliability.