

CLARIFIERS

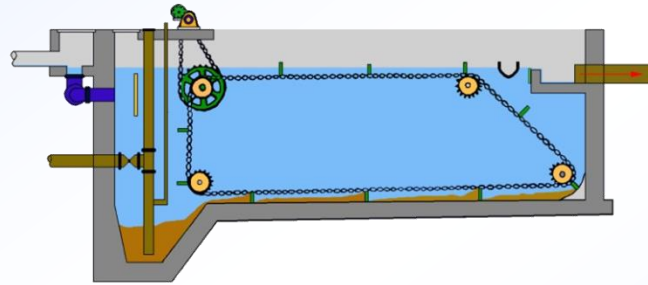
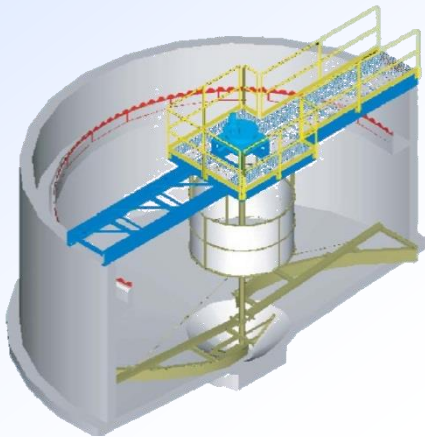

Prepared By
Michigan Department of Environmental Quality
Operator Training and Certification Unit

CLARIFIERS

Clarifiers
Sedimentation Basins
Settling Tanks

Provide Quiescent Area

Separation of Solids

 **Settleable** 
Floatable

Clarifiers

Efficiency of Solids Removal Related To:

1. Characteristics of the Solids

2. Characteristics of the Water

3. Characteristics of the Clarifier



Stoke's Law

$$VF = \frac{2(p - p_o)g}{9n} (d/2)^2$$

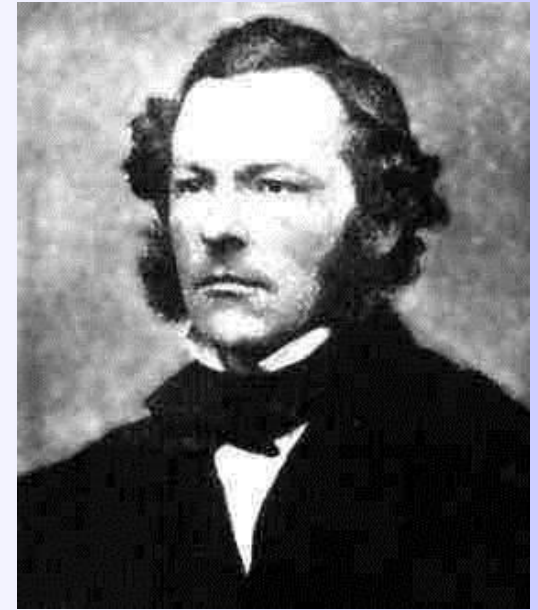

VF = **Fall Velocity**

(p - p_o) = **Density difference** between
particle and water

n = **viscosity** of water

g = **gravitational acceleration constant**

d = **diameter** of the particle



Stoke's Law

Forget the Formula
Remember the Removal
Efficiency Depends on Several
Factors

- VF** = **Fall Velocity**
- ($p - p_o$)** = **Density difference** between
particle and water
- n** = **viscosity** of water
- g** = **gravitational acceleration constant**
- d** = **diameter** of the particle

Particle Size versus Settling Time

Particle Size
mm

Order of Size

Time to Settle

1.0	Coarse Sand	3 Seconds
0.1	Fine Sand	38 Seconds
0.01	Silt	33 Minutes
0.001	Bacteria	55 Hours
0.0001	Colloidal	230 Days
0.00001	Colloidal	6.3 Years

Clarifiers

Efficiency of Solids Removal Related To:

1. Characteristics of the Solids

2. Characteristics of the Water

3. Characteristics of the Clarifier





Stoke's Law

Forget the Formula
Remember the Removal
Efficiency Depends on Several
Factors

VF

= Fall Velocity

($p - p_0$)

**= Density difference between
particle and water**

n

= viscosity of water

g

= gravitational acceleration constant

d

= diameter of the particle

Settling Rate

Cold Water

More Dense

More Viscous

Warm Water

Less Dense

Less Viscous

**Solids Settle More Readily in Warm Water
Than in Cold Water**

Warm Water - Greater Efficiency of Clarification

Cool Water- Less Efficiency of Clarification

Clarifiers

Efficiency of Solids Removal Related To:

1. Characteristics of the Solids

2. Characteristics of the Water

3. Characteristics of the Clarifier



Clarifiers

Efficiency of Solids Removal Related To:

3. Characteristics of the Clarifier

Surface Area

Depth

Hydraulic Loading

Solids Loading



Clarifiers

Efficiency of Solids Removal Related To:

3. Characteristics of the Clarifier

Surface Area

Depth

Hydraulic Loading

Solids Loading

Design

Operation

Maintenance



Clarifiers

Efficiency of Solids Removal Related To:

3. Characteristics of the Clarifier

Flow Characteristics in the Clarifier

Flow Must be Dispersed Evenly Throughout



Clarifier Short Circuiting

Higher Flow (Horizontal Velocity) in One Part of Tank

Density Currents

Currents Within the Tank Carry Solids Through the Tank.

Not the Same as Excessive Hydraulic Load
(Detention Time vs. Fall Velocity)

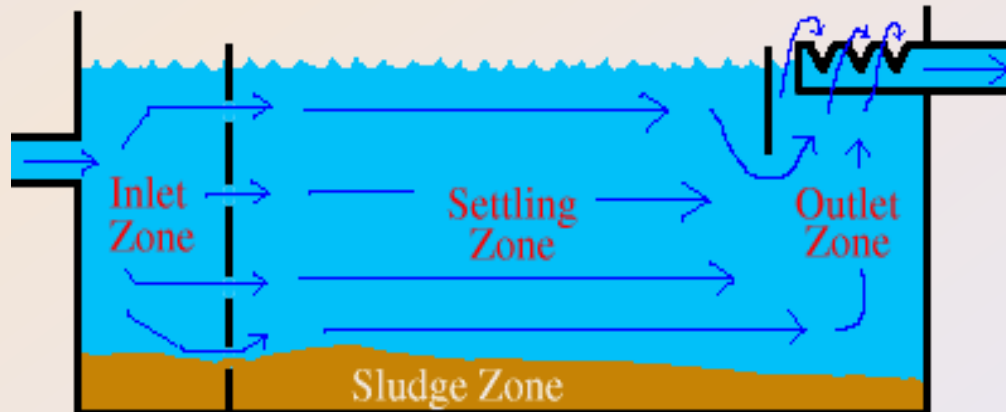

Clarifier Short Circuiting

Causes

Missing or poor influent baffling

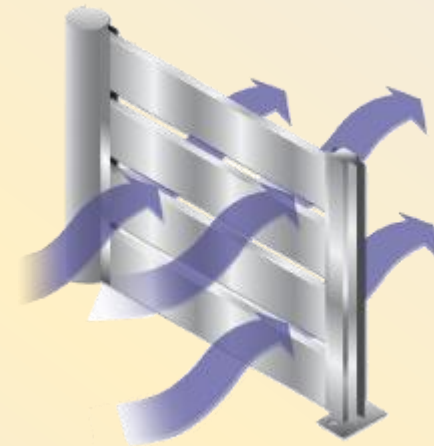
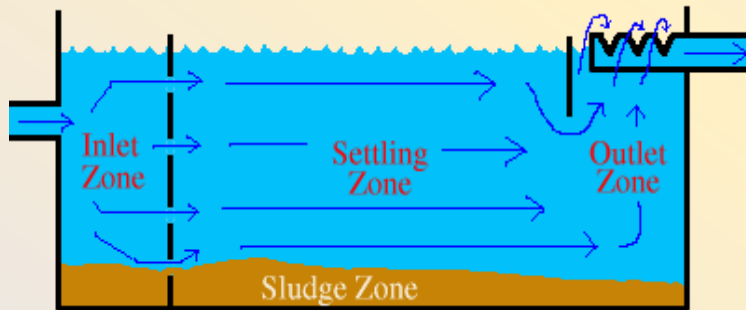

Clarifier Short Circuiting

Causes

Missing or poor influent baffling

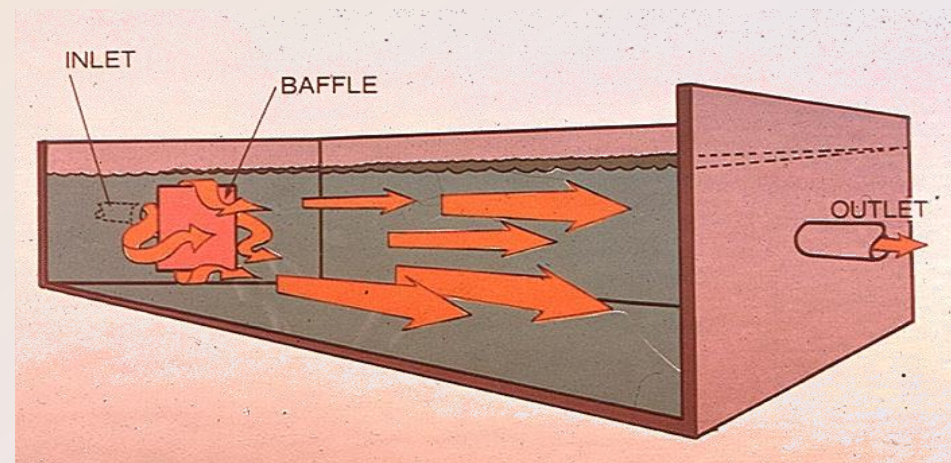
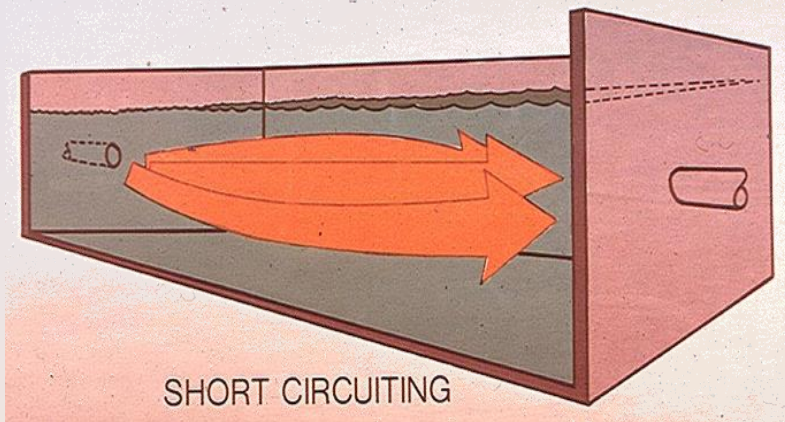

Clarifier Short Circuiting

Causes

Missing or poor influent baffling

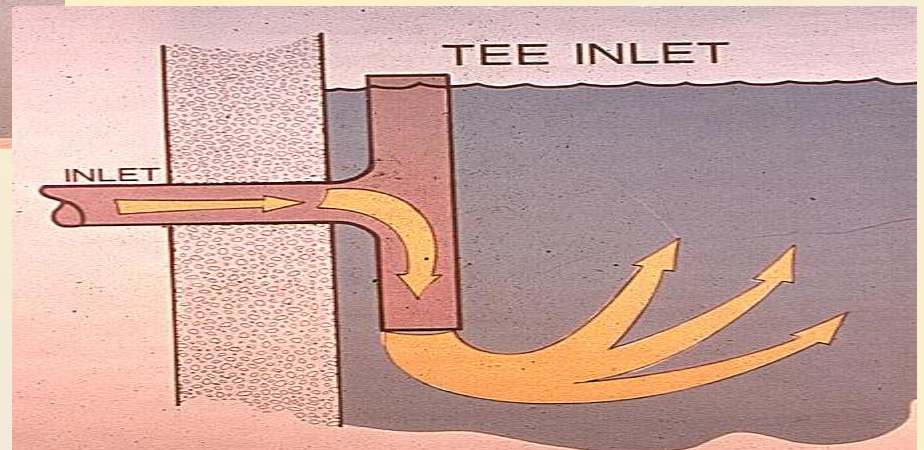
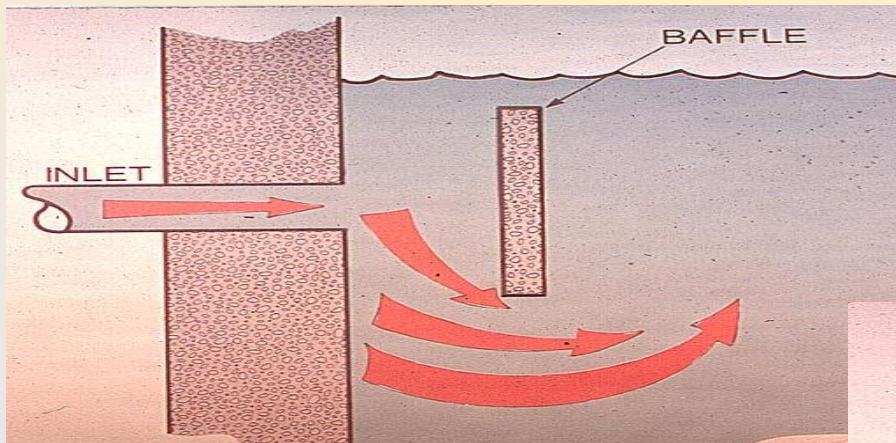

Clarifier Short Circuiting

Causes

Uneven effluent weirs

Plant growth or thrash in effluent weirs



Clarifier Short Circuiting

Causes

Temperature stratification between influent & clarifier water temperatures.

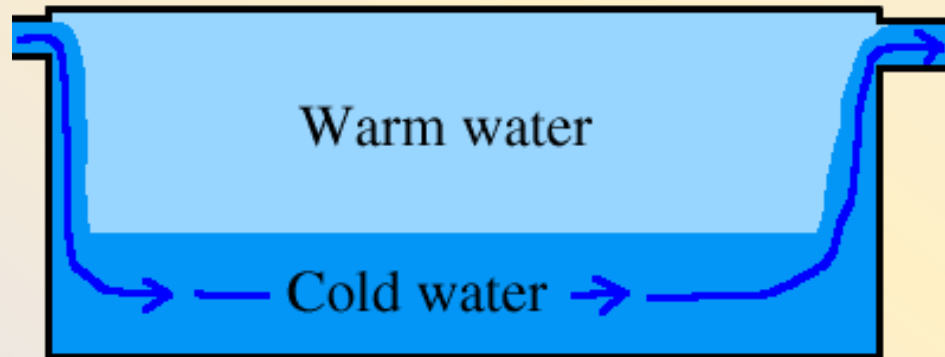

Clarifier Short Circuiting

Monitoring for Short Circuiting

Visual Observation

Flow Over Weir

Solids Over Weir



Clarifier Short Circuiting

Monitoring for Short Circuiting

Dye Testing



Clarifier Short Circuiting

Higher Flow (Horizontal Velocity) in One Part of Tank

Density Currents

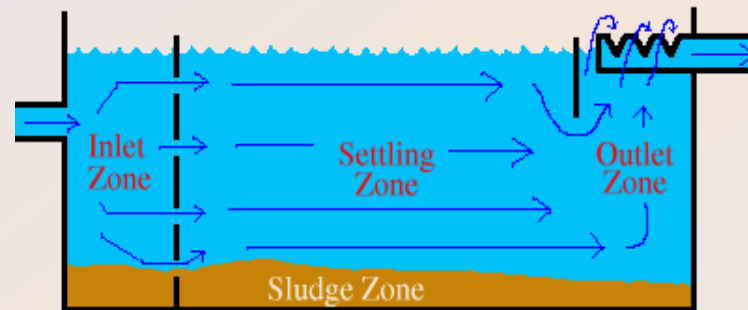

Clarifier Short Circuiting

Causes

- **Missing or poor influent baffling**
- **Uneven effluent weirs**
- **Plant growth or thrash in effluent weirs**
- **Temperature stratification between influent & clarifier water temperatures.**

Clarifiers

Efficiency of Solids Removal Related To:

- 1. Characteristics of the Solids**
- 2. Characteristics of the Water**
- 3. Characteristics of the Clarifier**



Clarifiers

Types of Clarifiers

**Inclined Plate
(Lamella)**

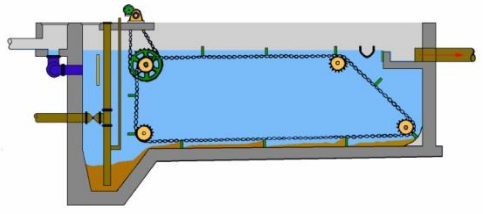
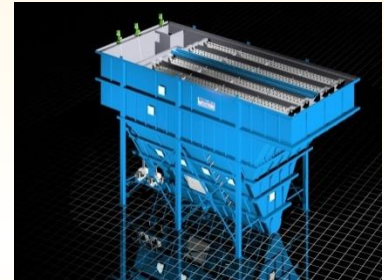

Rectangular

Circular



Inclined Plate (Lamella)

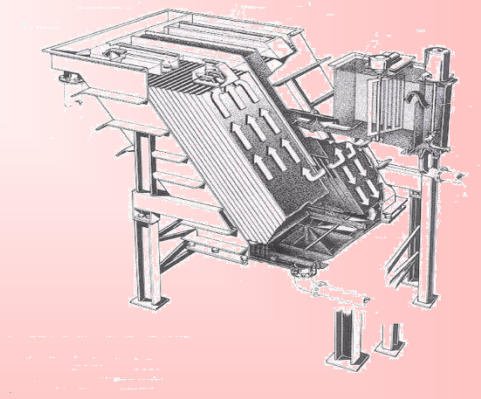

Types of Clarifiers – Inclined Plate (Lamella)

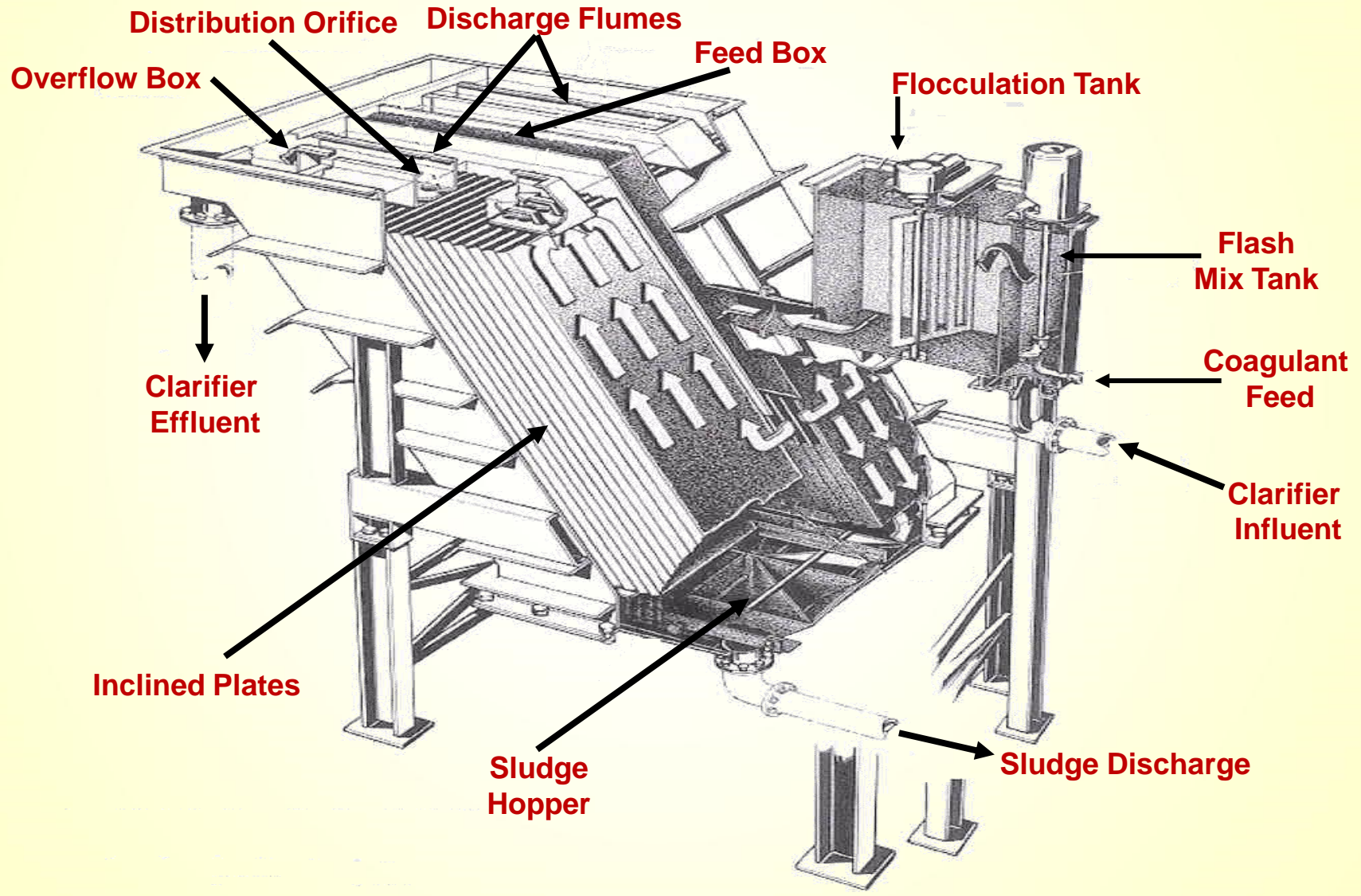

Types of Clarifiers – Inclined Plate (Lamella)

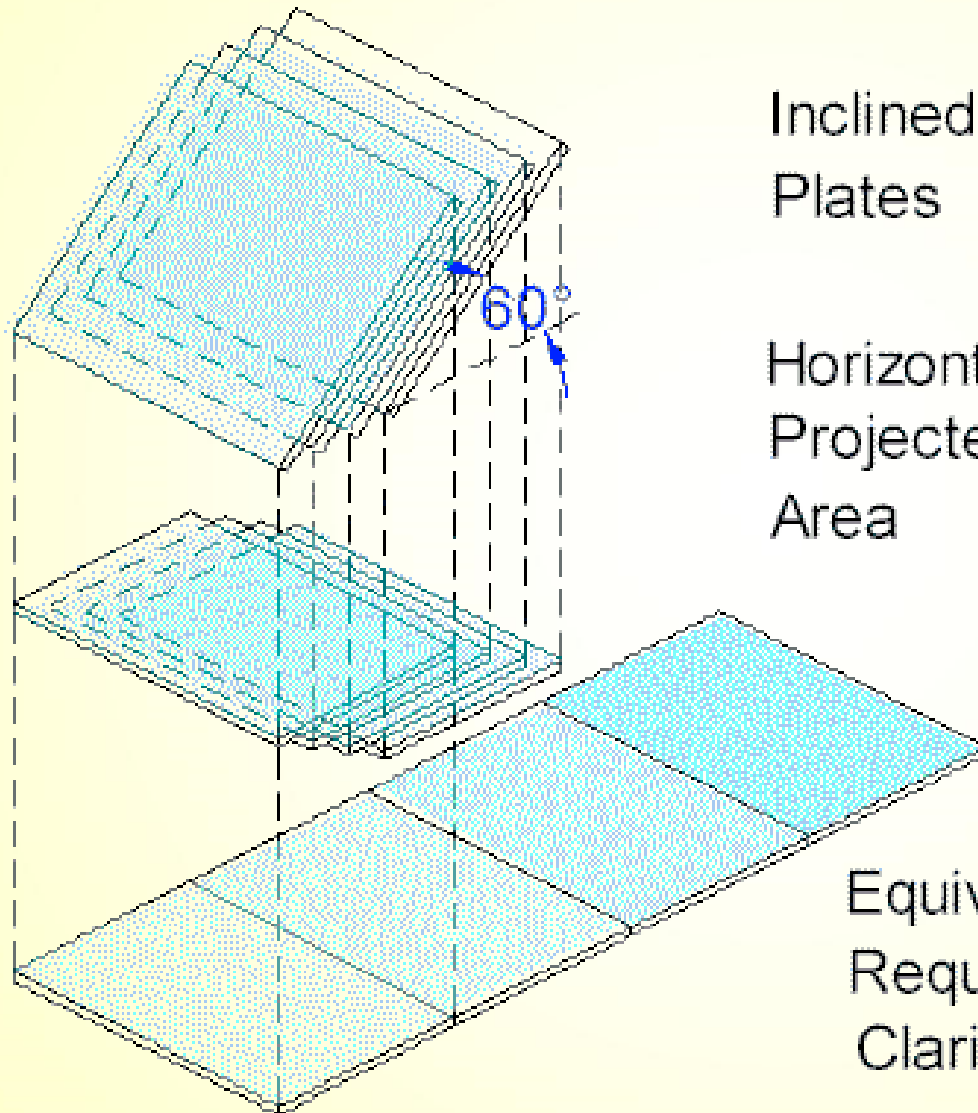

Inclined
Plates

Horizontal
Projected
Area

Equivalent Floor Space
Required by a Horizontal
Clarifier



Types of Clarifiers – Inclined Plate (Lamella)

Increased settling efficiency due to increased surface area

Smaller Area Needed for Installation

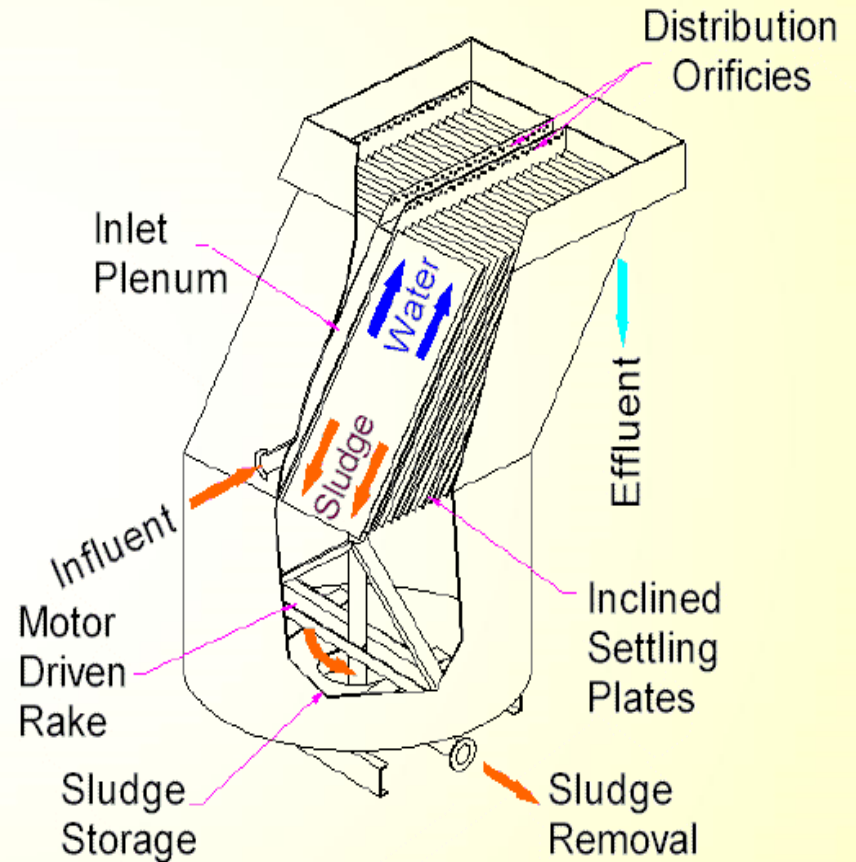

Types of Clarifiers – Inclined Plate (Lamella)

Increased settling efficiency due to increased surface area

Smaller Area Needed for Installation

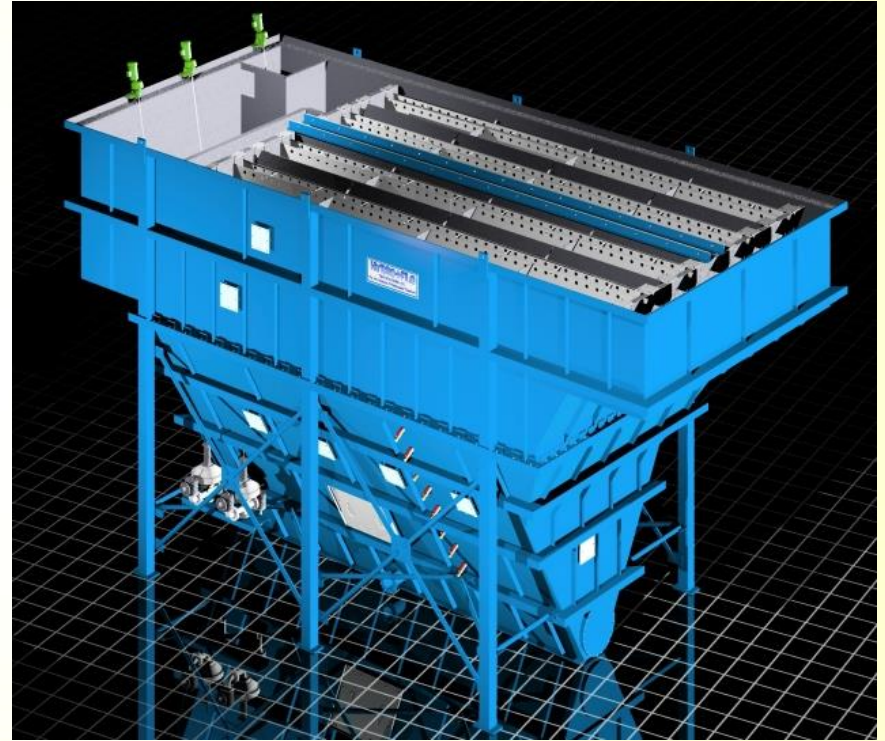

Types of Clarifiers – Inclined Plate (Lamella)

Seldom Used With Organic Wastes

Biological Growths Reduce Efficiency

Mostly Industrial Applications

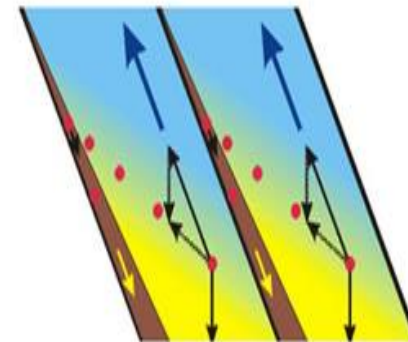
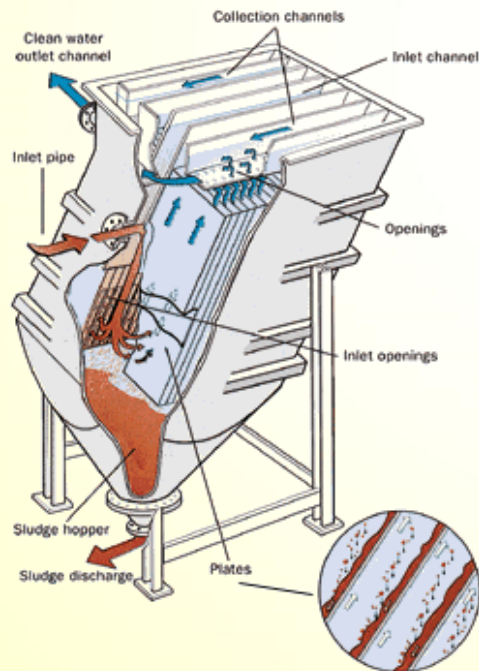

- direction of flow of dirty water/clean water
- direction of flow of the sludge
- vectors speed of flow and settling speed
- way of flow of a solid particle

Rectangular Clarifiers

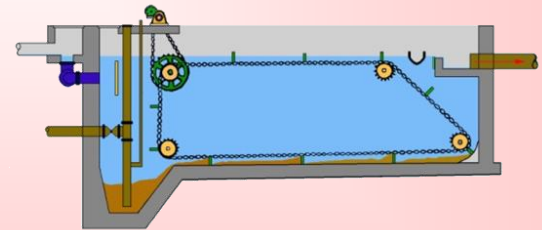

Types of Clarifiers – Rectangular

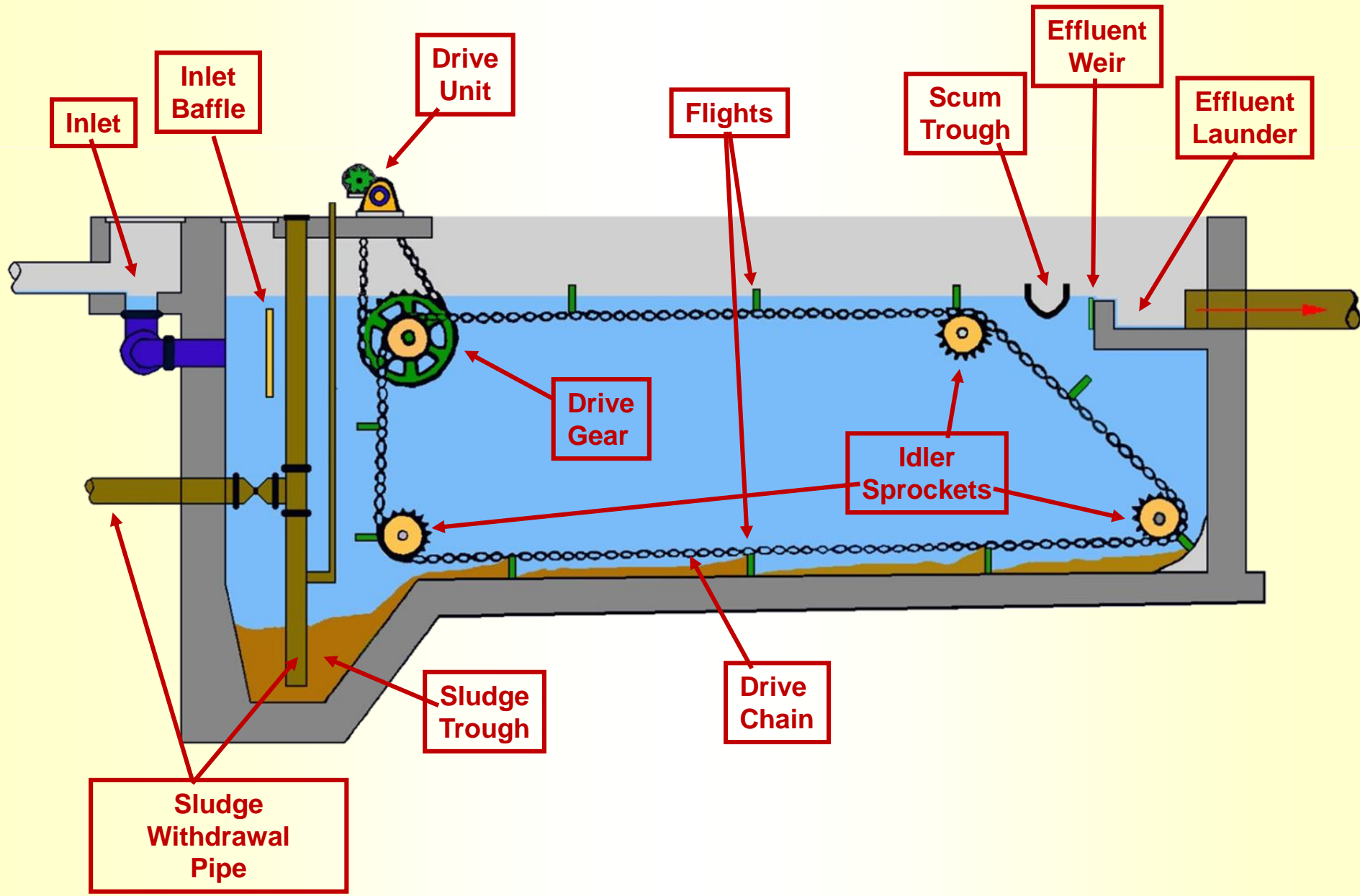

Types of Clarifiers – Rectangular

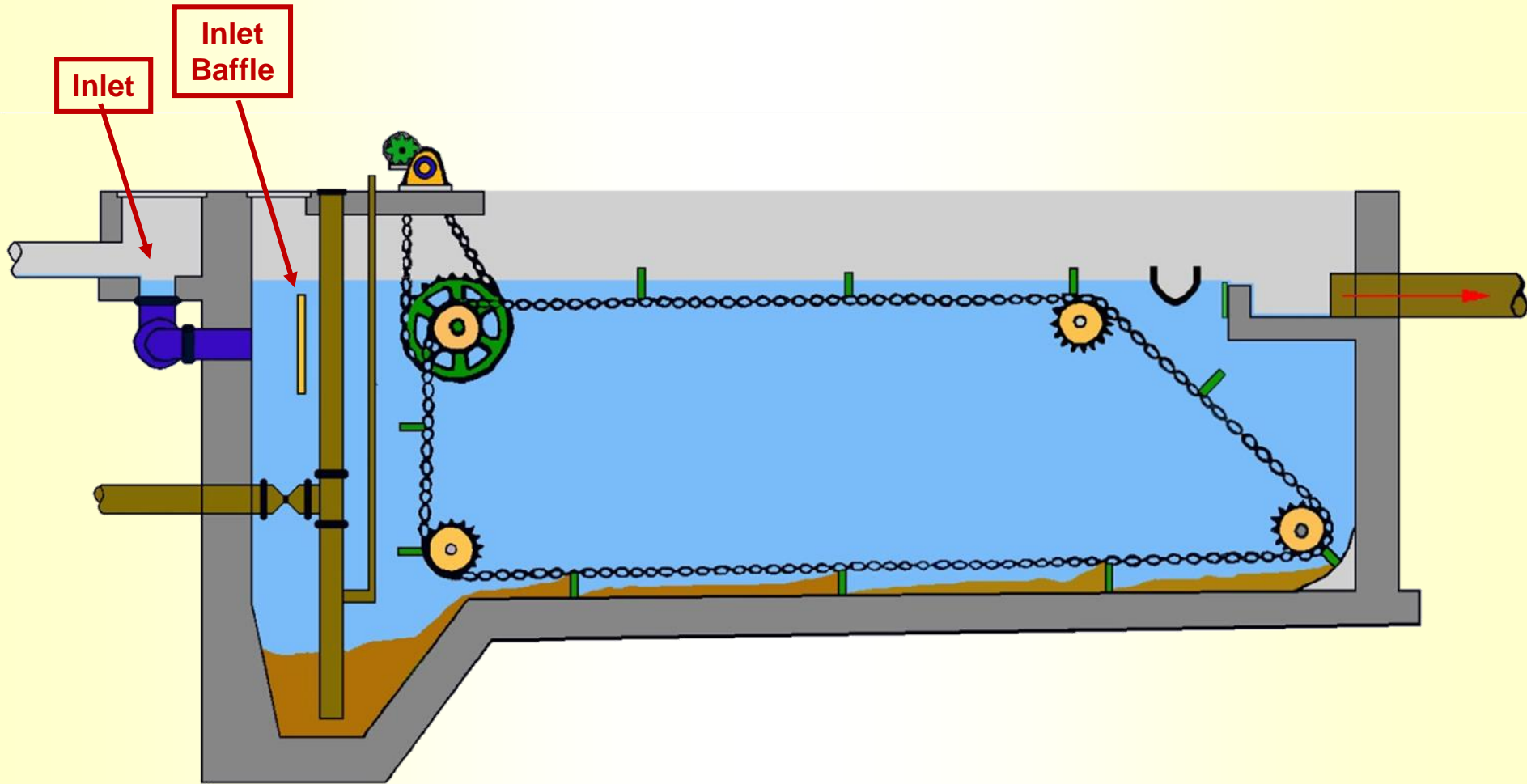

Types of Clarifiers – Rectangular

Influent baffling

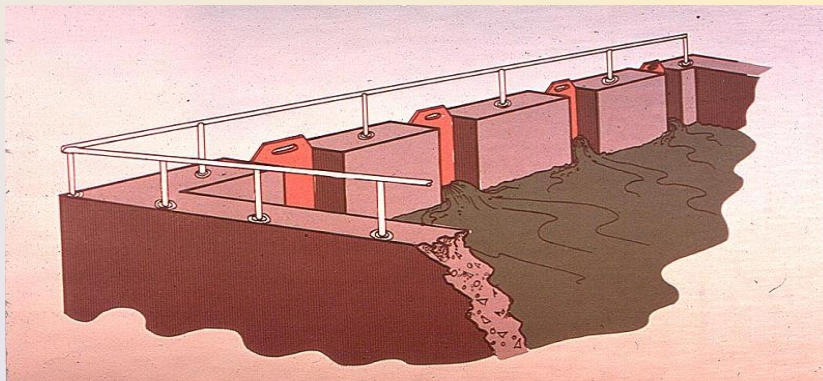
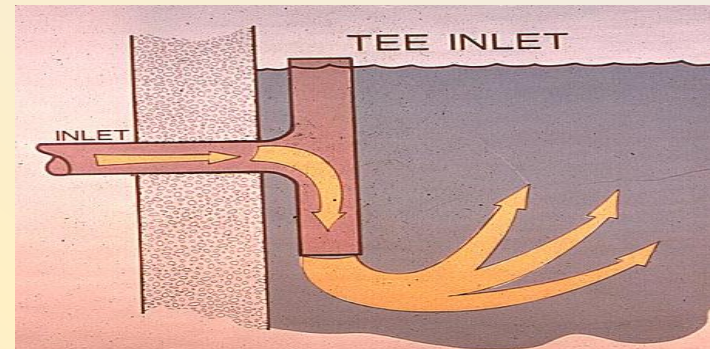
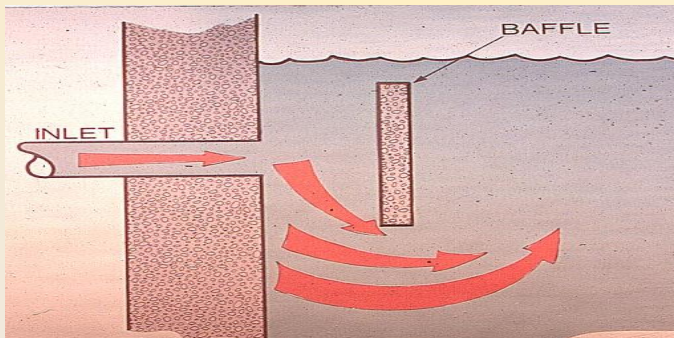

Types of Clarifiers – Rectangular

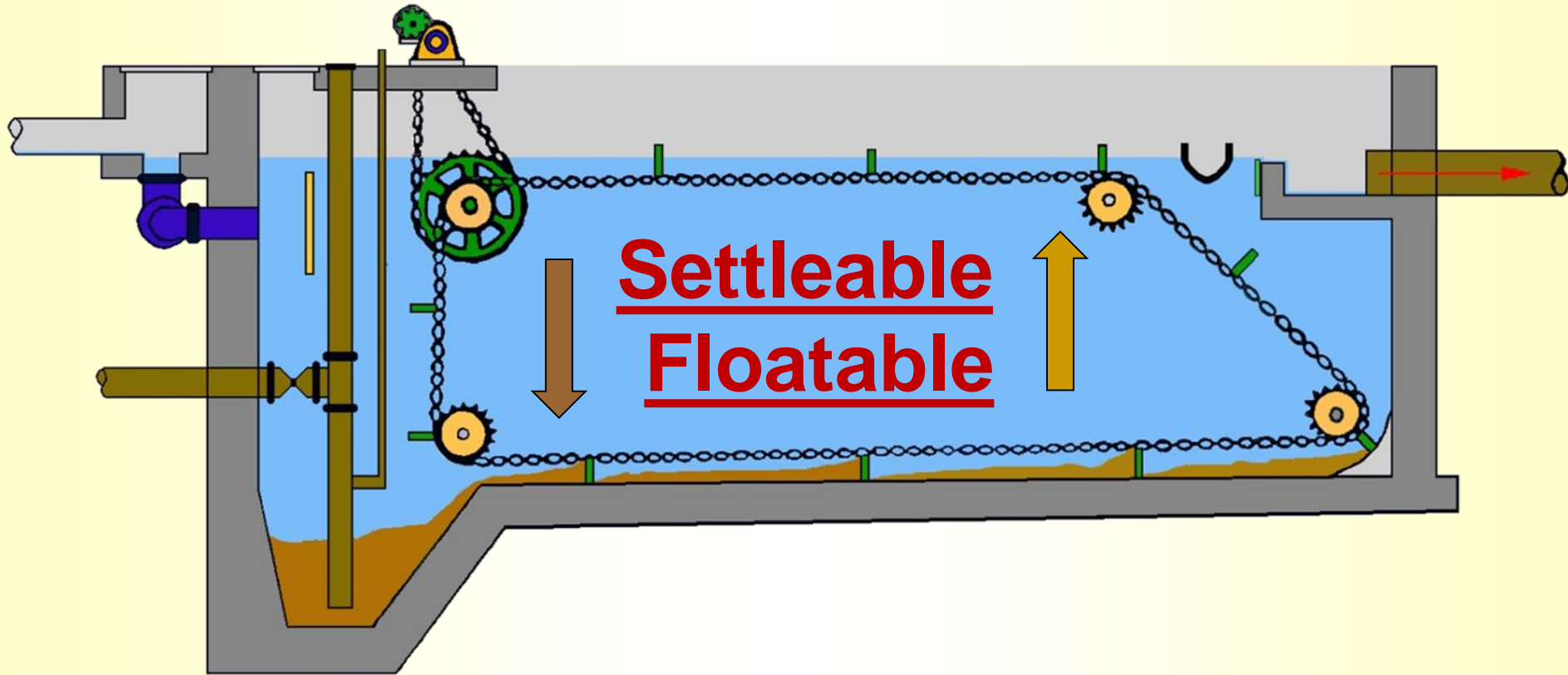

Types of Clarifiers – Rectangular

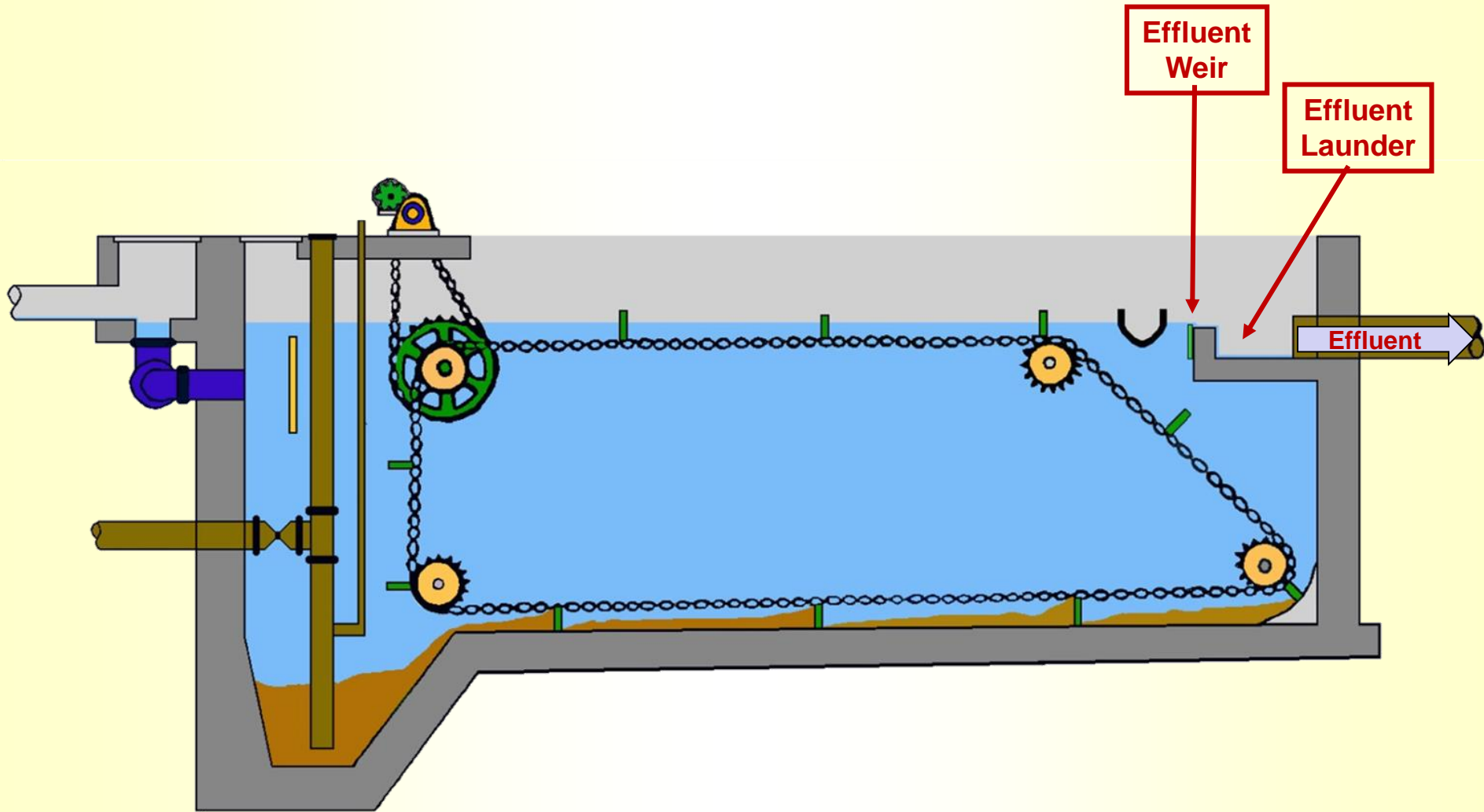

Types of Clarifiers – Rectangular

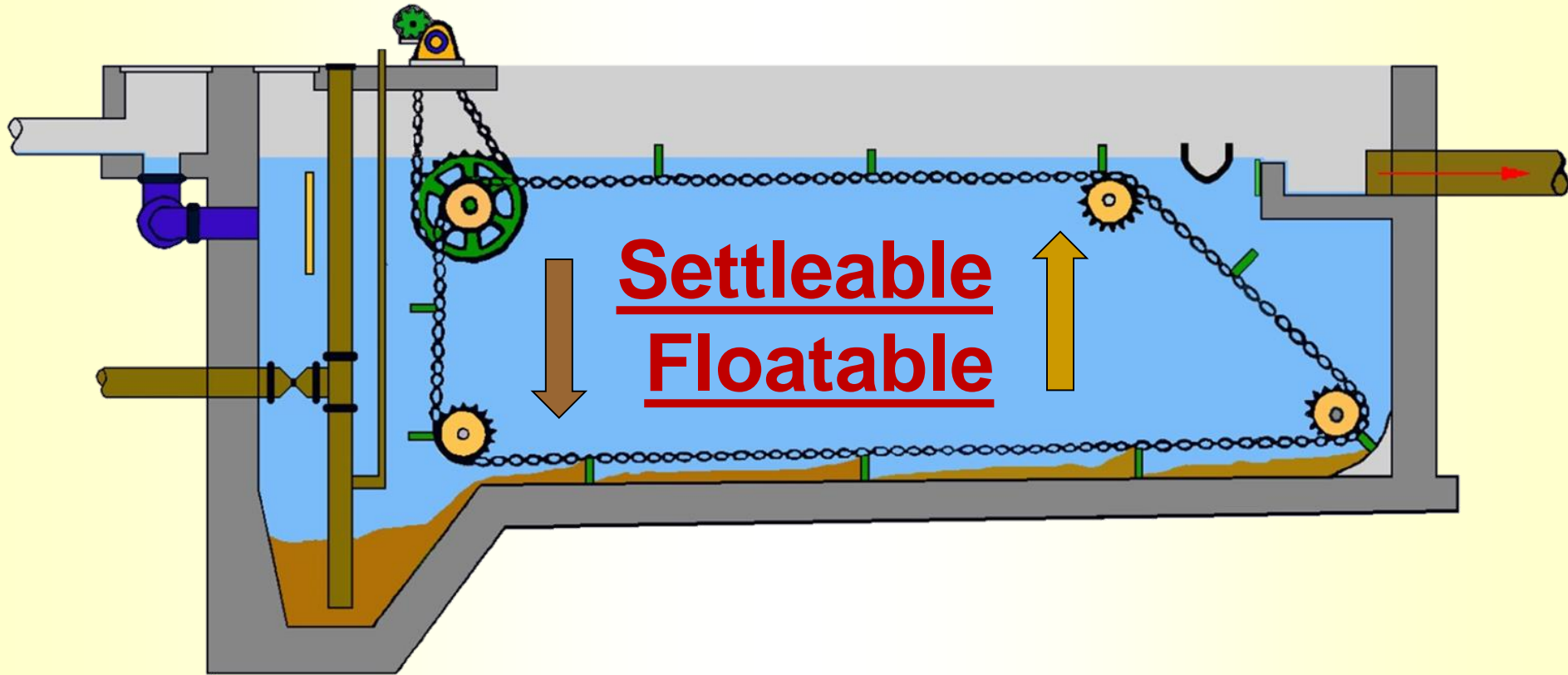

Types of Clarifiers – Rectangular

Solids Removal Mechanism

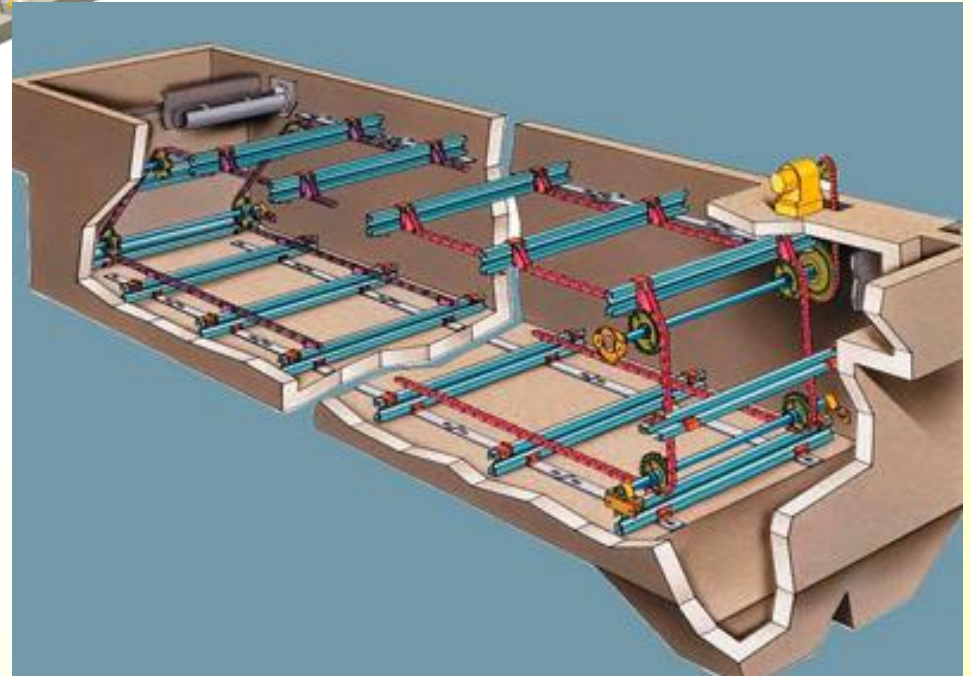
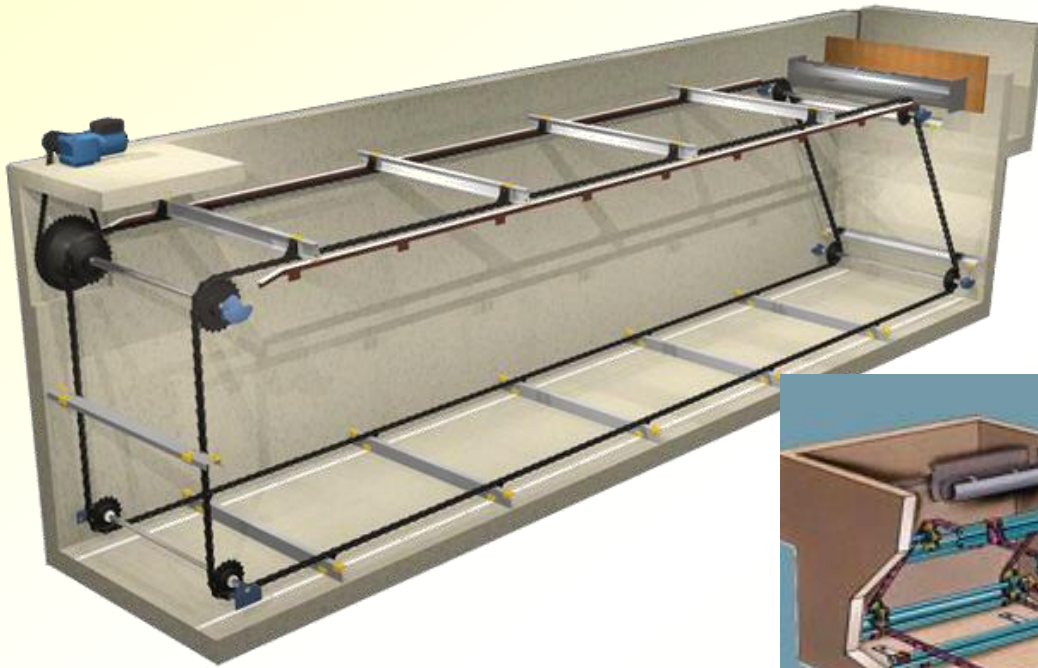

Types of Clarifiers – Rectangular

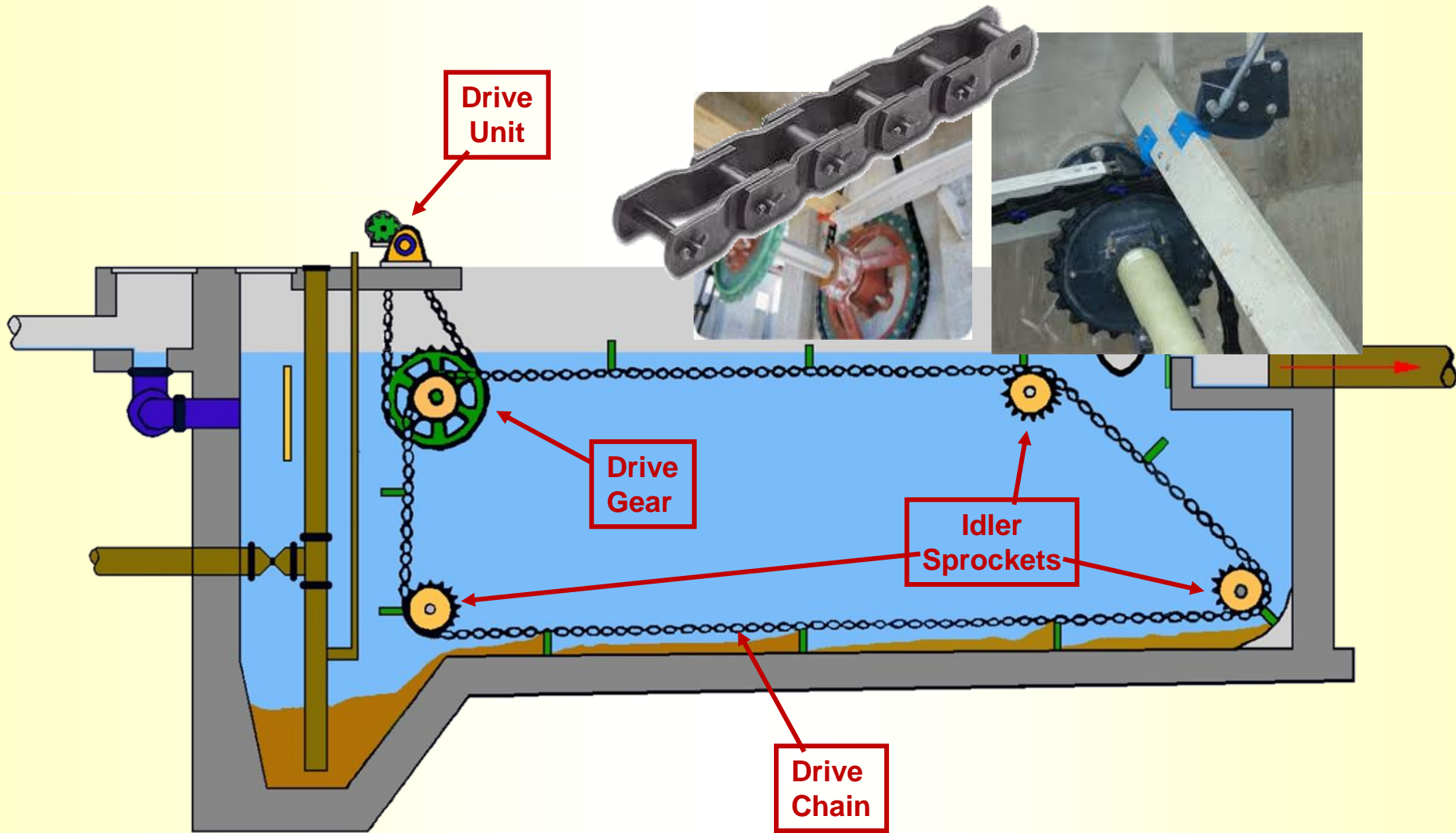

Types of Clarifiers – Rectangular

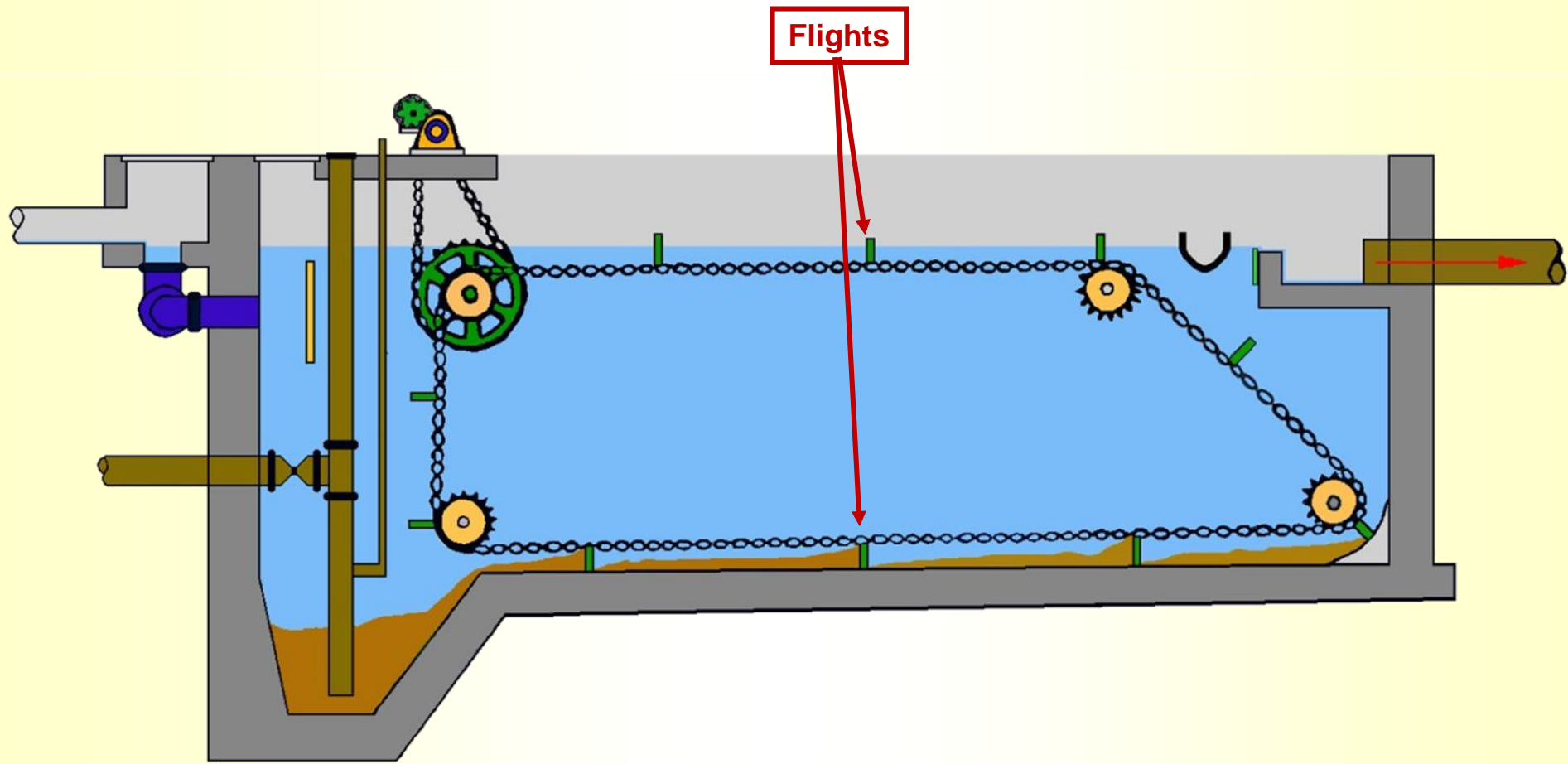

Types of Clarifiers – Rectangular

Flights

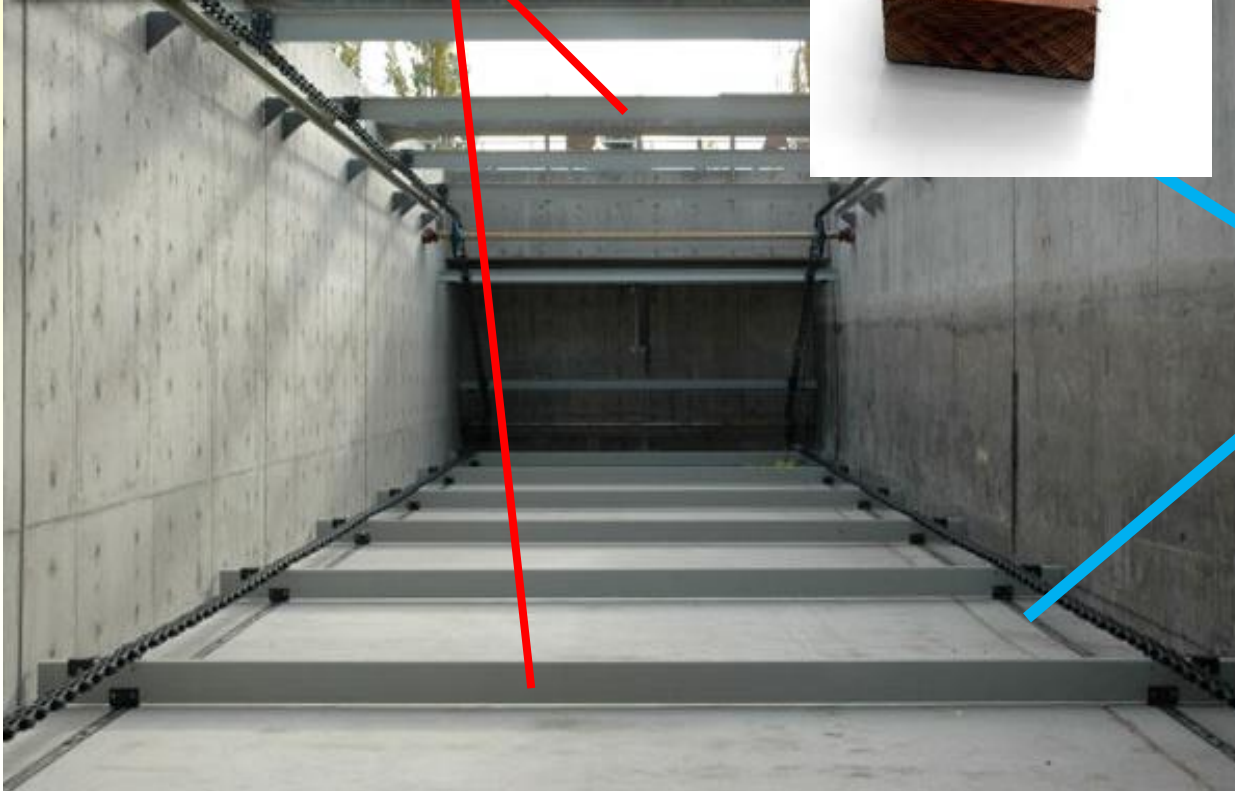
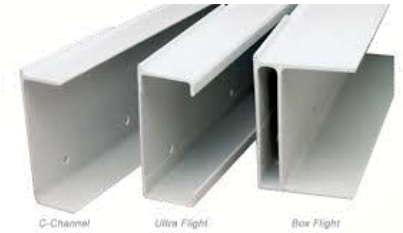

Rails

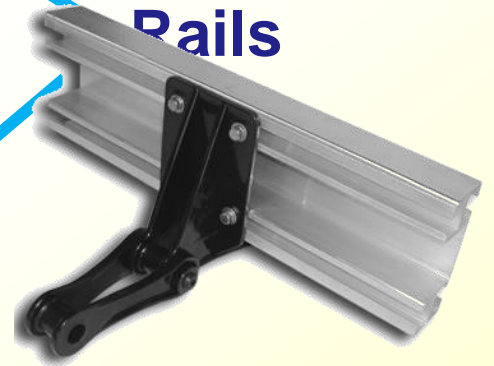

Types of Clarifiers – Rectangular



Wear Shoes

Rails

Types of Clarifiers – Rectangular

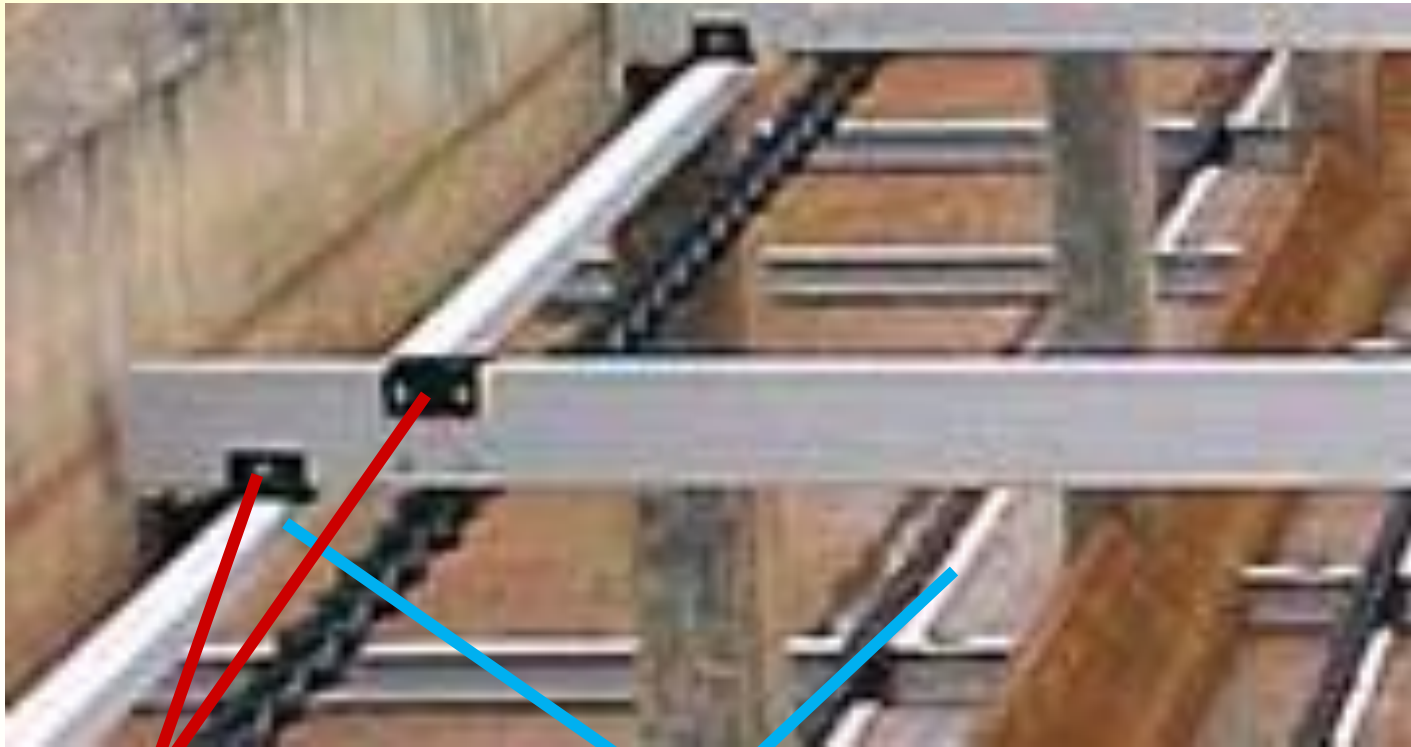

Wear Shoes

Rails

Prevent Wear on the Flights Where They Contact the Rails

Transfer Wear to the Shoe Instead of the Flights

Types of Clarifiers – Rectangular

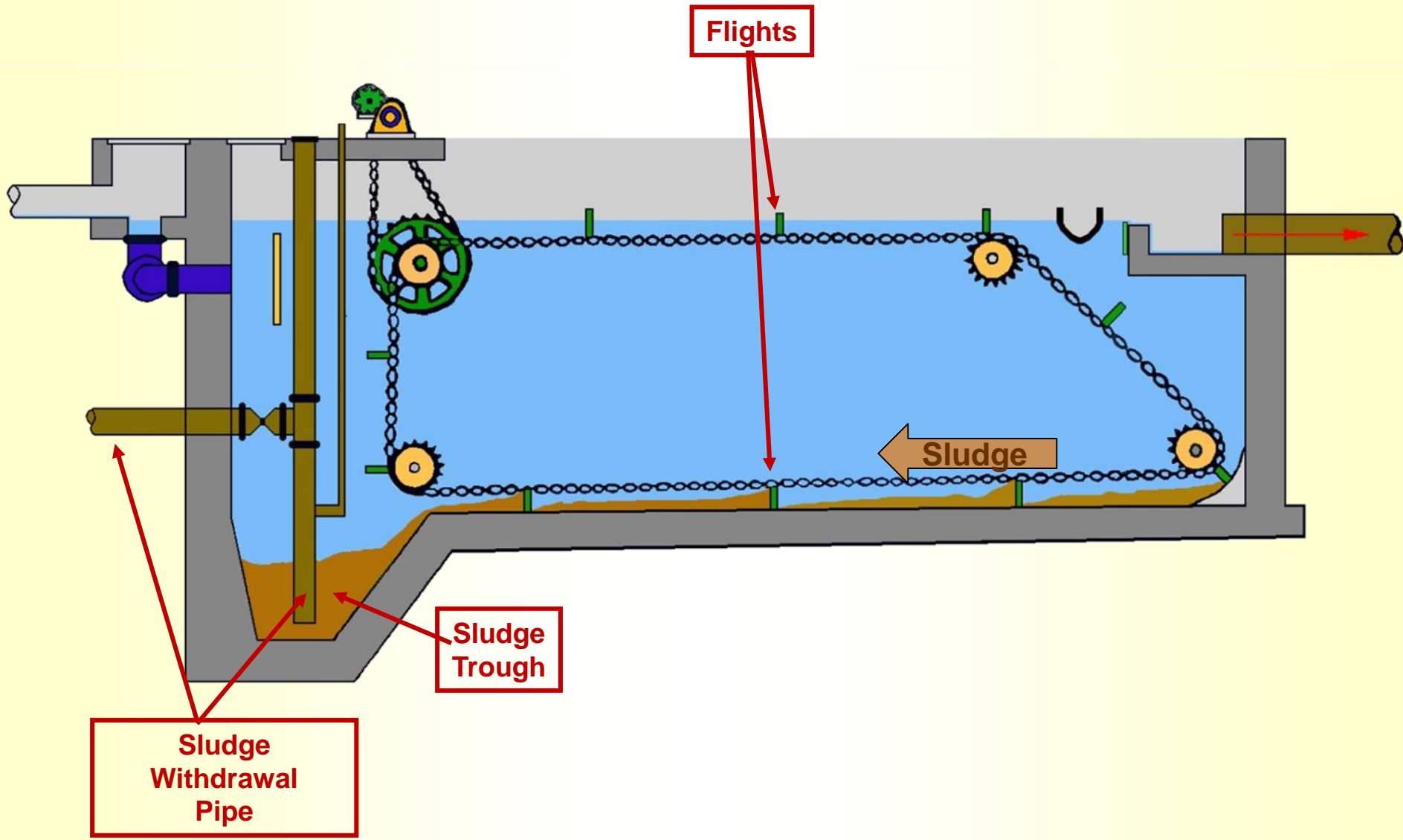

Types of Clarifiers – Rectangular

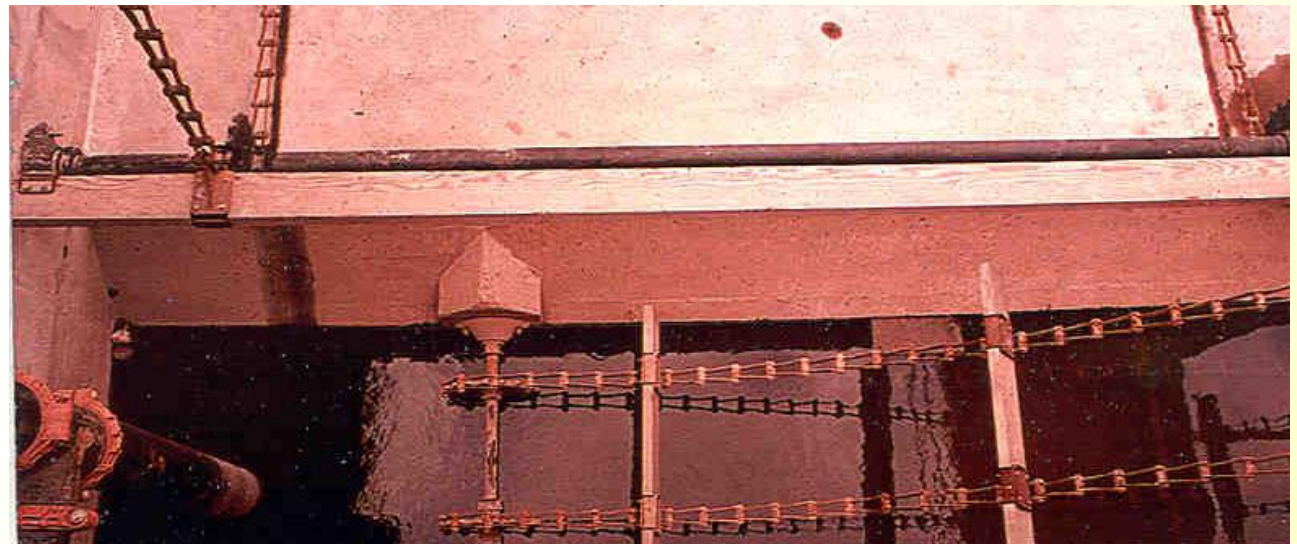
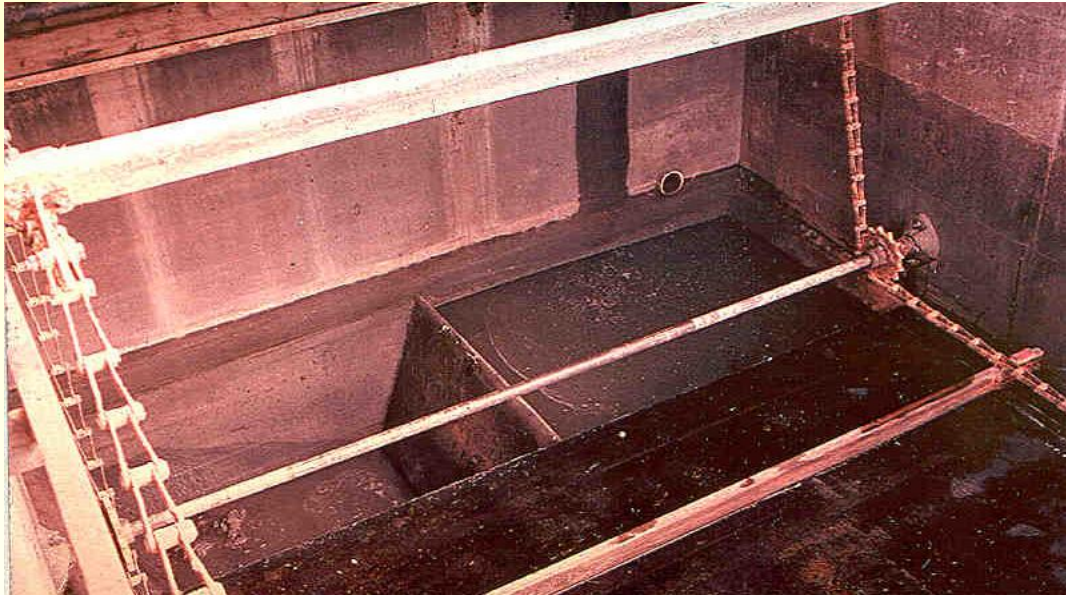

Types of Clarifiers – Rectangular

Scum Removal

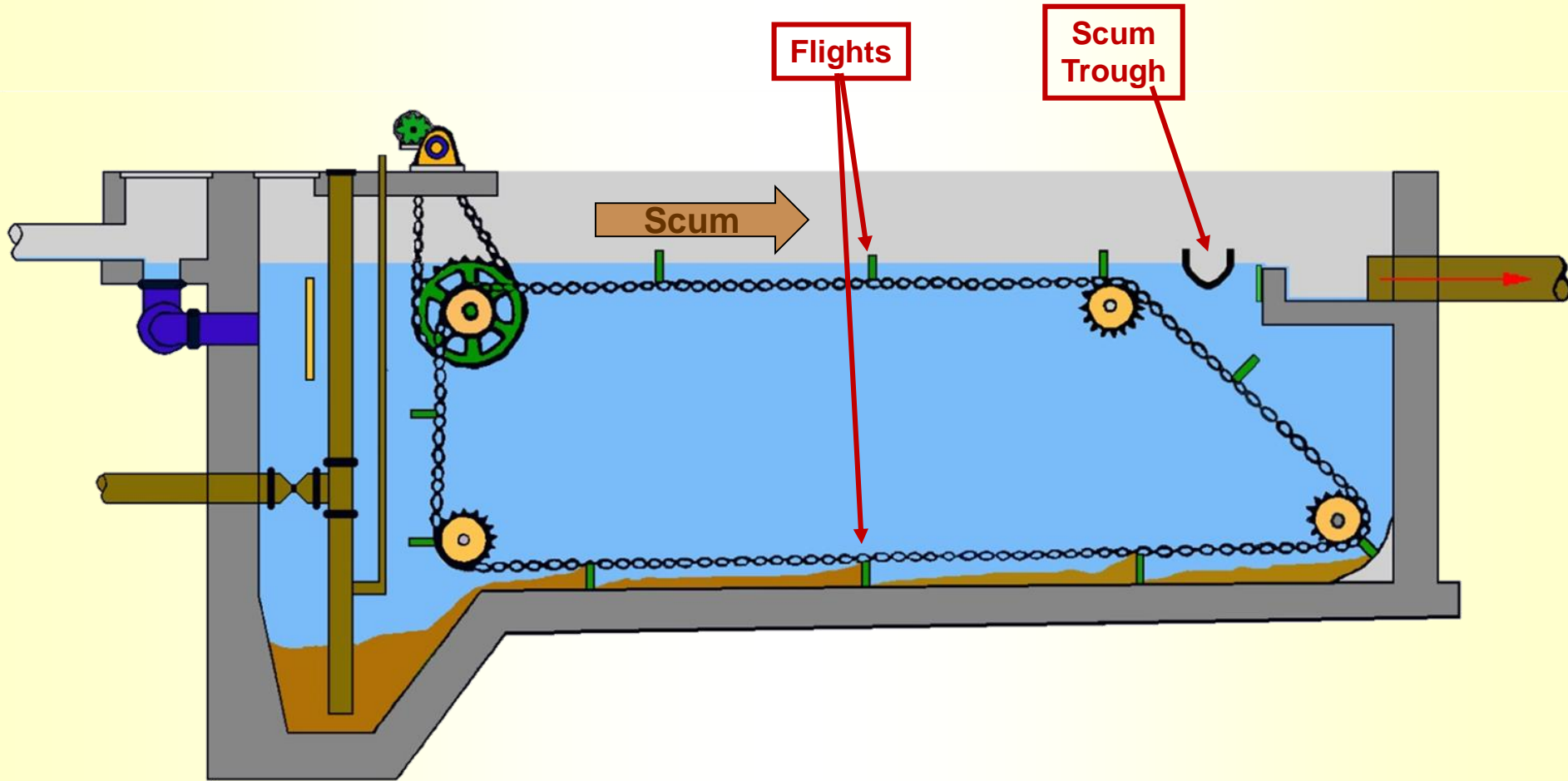

Types of Clarifiers – Rectangular

Scum Removal

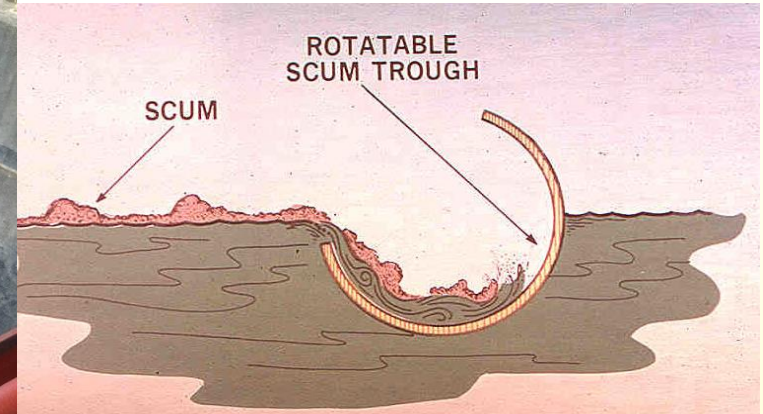

Types of Clarifiers – Rectangular

Scum Removal

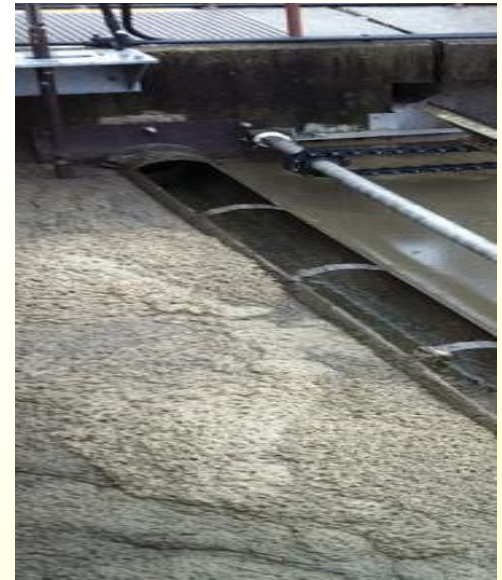

Types of Clarifiers – Rectangular

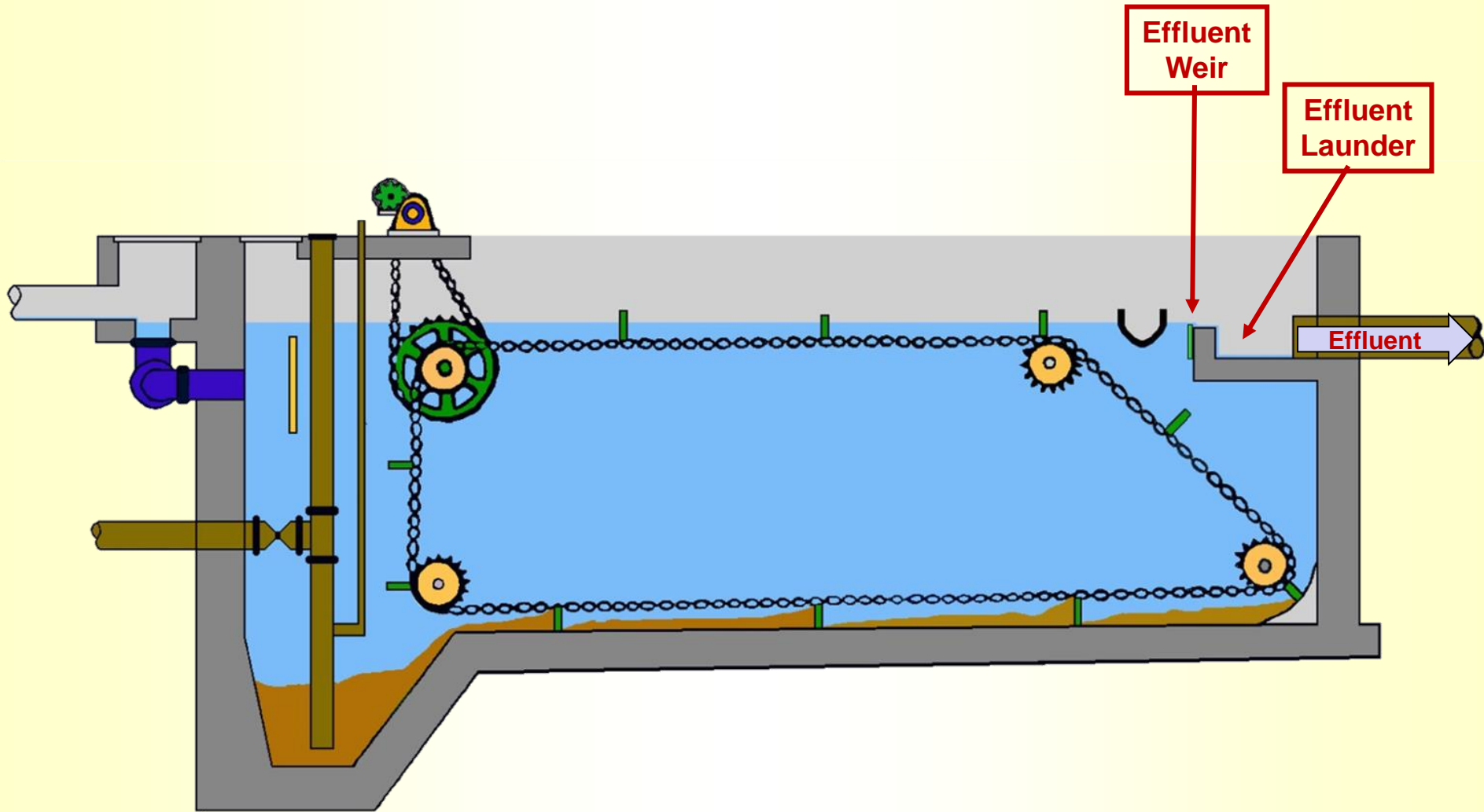

Types of Clarifiers – Rectangular

Effluent Weir – “V Notch”

Flow = Velocity X Area

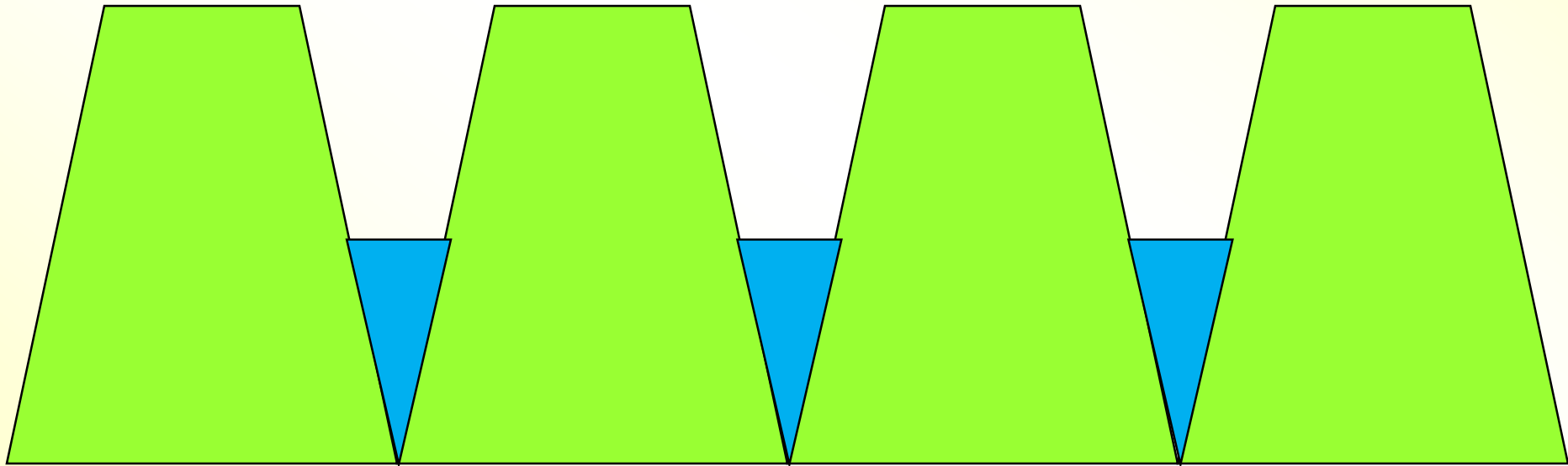

Types of Clarifiers – Rectangular

Effluent Weir – “V Notch”

Flow = Velocity X Area

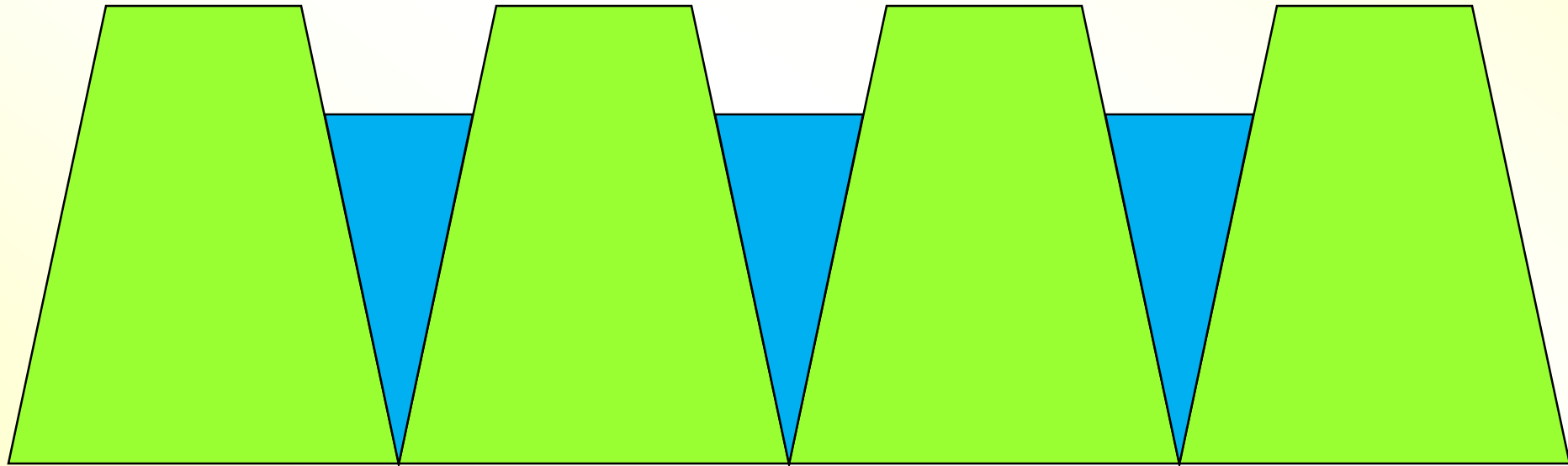

As Flow Increases, Area Increases

And As Area Increases, Velocity Decreases

Types of Clarifiers – Rectangular

Effluent Weir – “V Notch”



Helps Keep Velocity Constant

Reduces Solids Build-up Behind Weir

Types of Clarifiers – Rectangular

Effluent Weirs

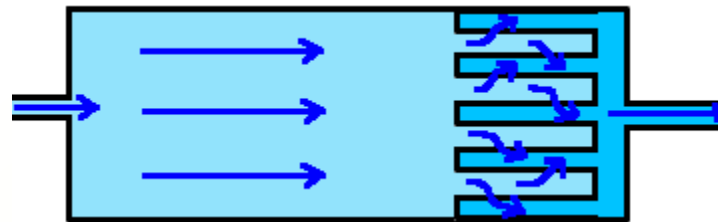
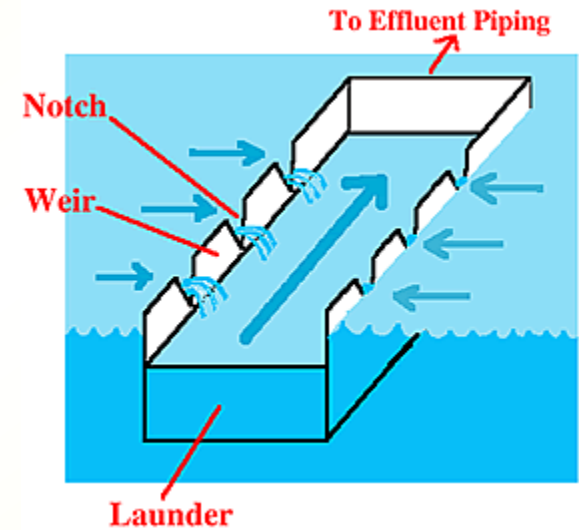
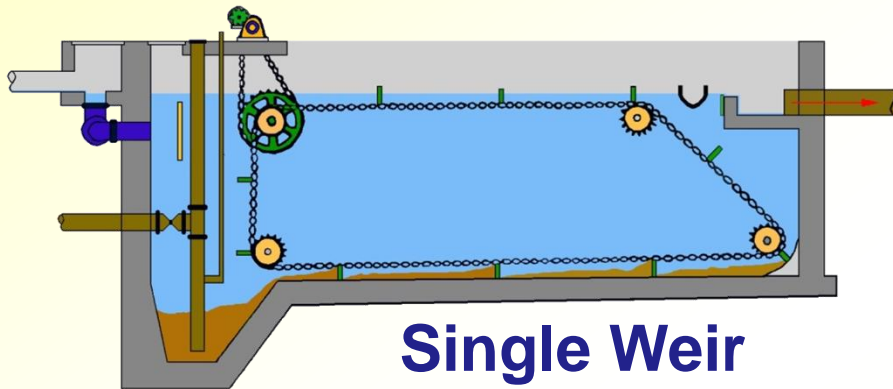

Finger Weirs

Types of Clarifiers – Rectangular

Effluent Weirs



Types of Clarifiers – Rectangular

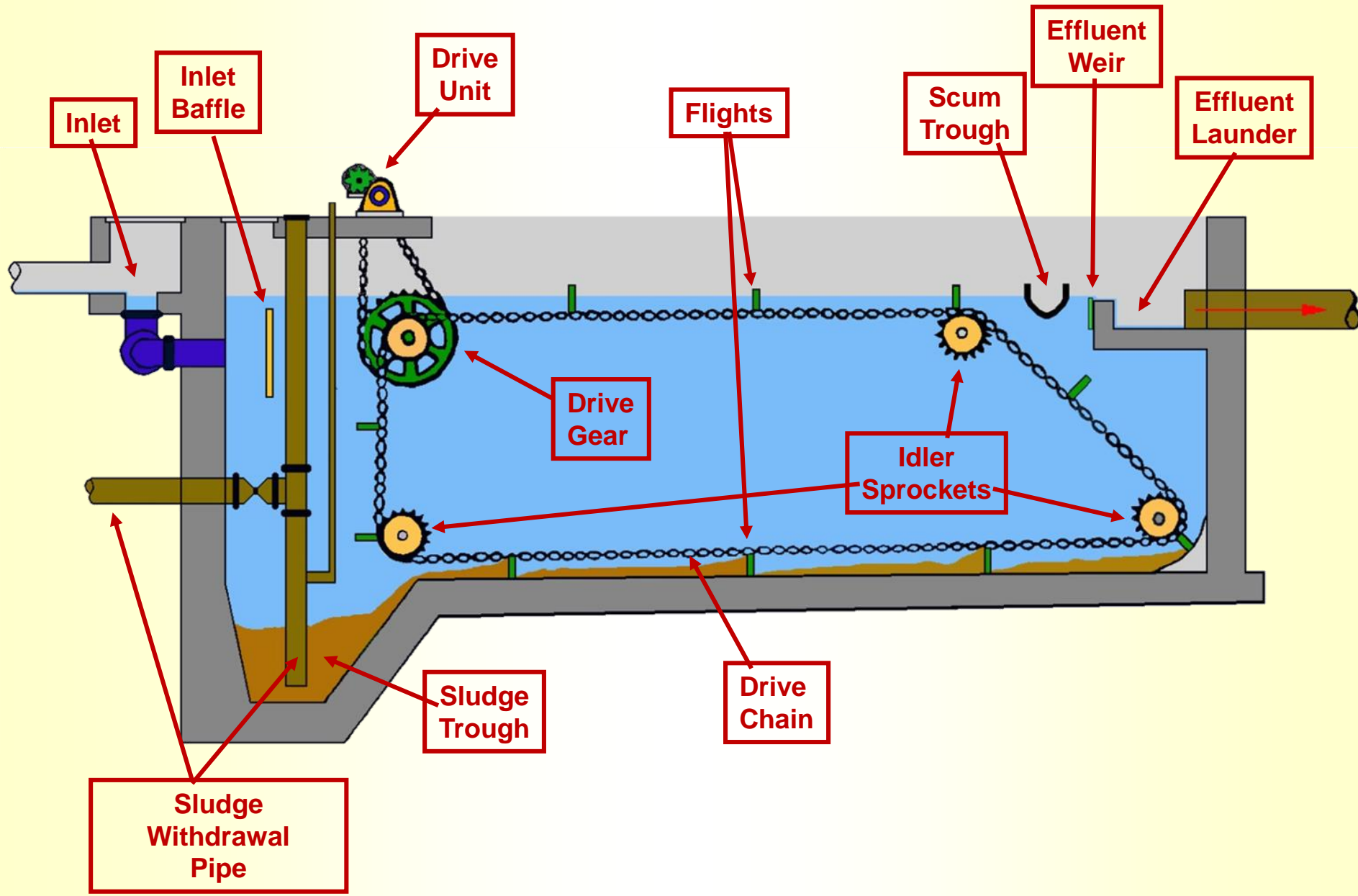

Secondary Rectangular Clarifiers – Most Important

Monitor for Short Circuiting

Visual Observation



Flow Over Weir
Solids Over Weir
Dye Testing



Consider Baffles



Circular Clarifiers

Circular Clarifier



Circular Clarifier

Influent typically enters the basin from the center rather than from one end.

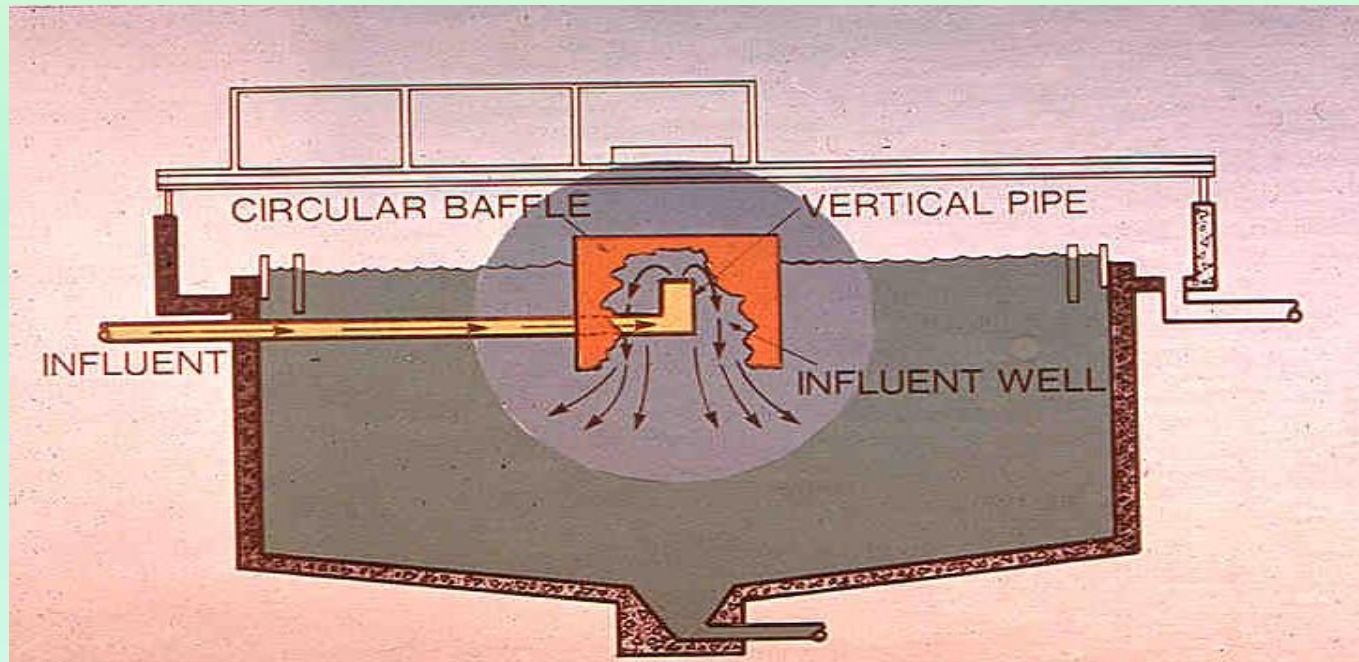

Circular Clarifier

Influent typically enters the basin from the center rather than from one end.

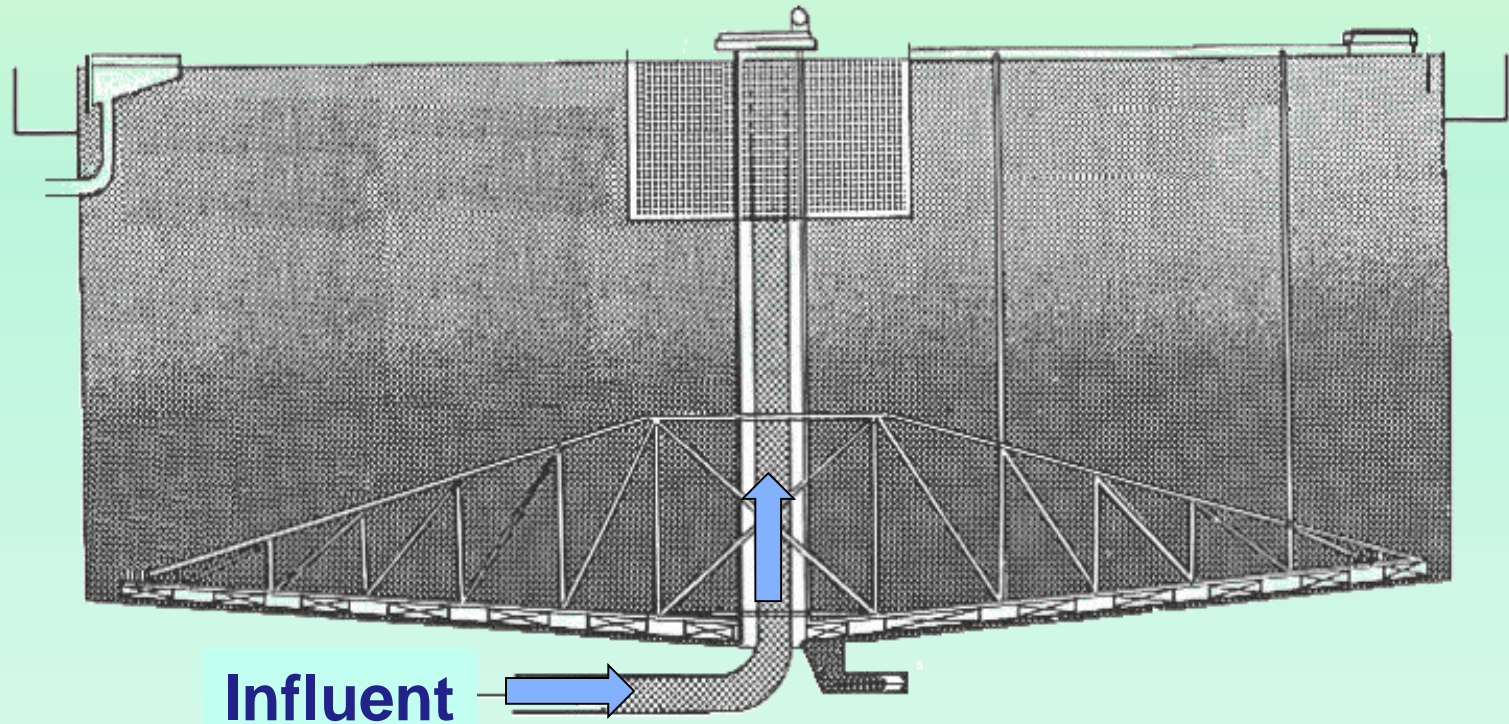

Circular Clarifier

A Circular Baffle Directs Flow

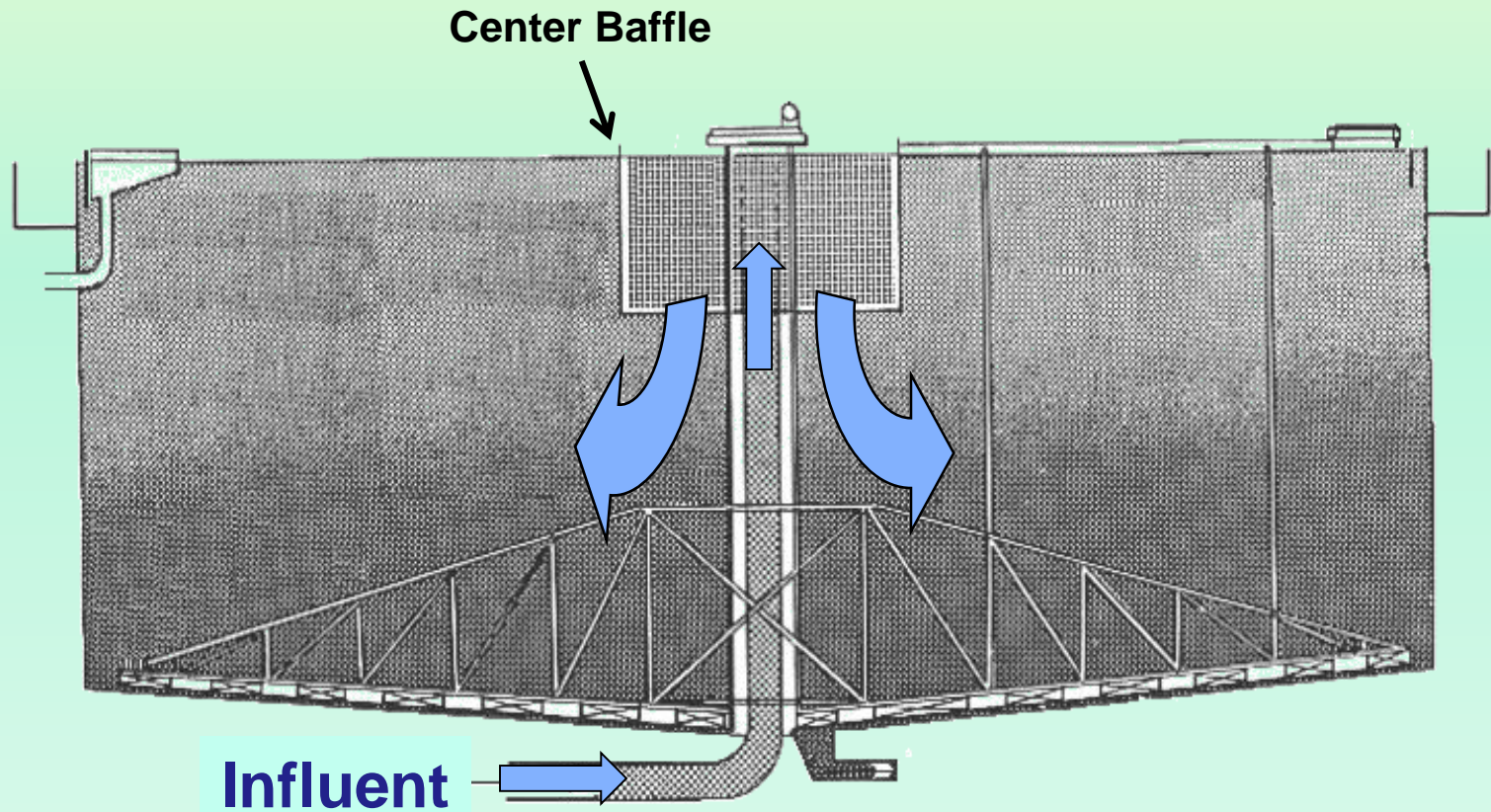

Circular Clarifier

A Circular Baffle Directs Flow



Circular Clarifier

Solids Settle
Scraped to Sump
Removed by Pumping

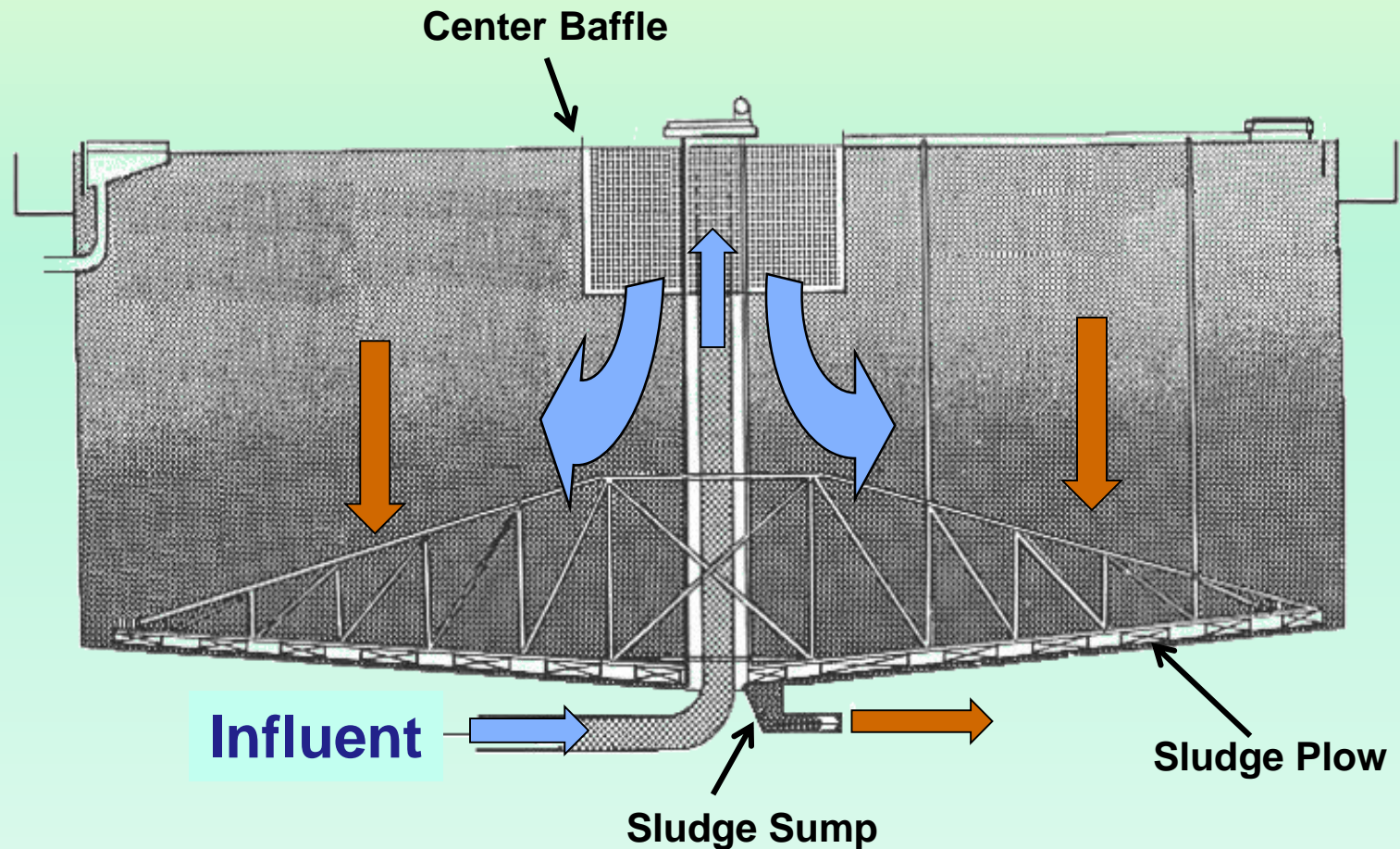

Circular Clarifier

**Solids Settle
Scraped to Sump
Removed by Pumping**

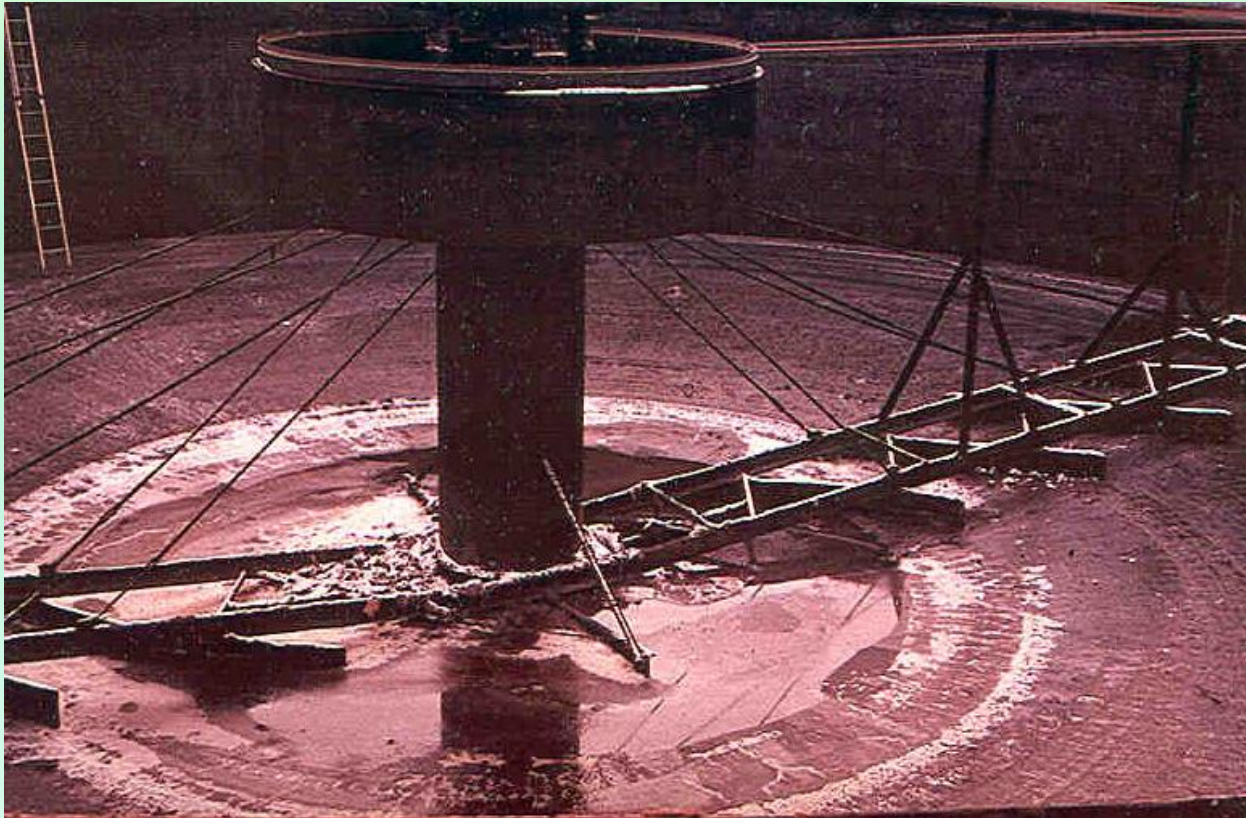

Circular Clarifier

Solids Settle
Scraped to Sump
Removed by Pumping



Circular Clarifier

Drive Mechanism Also Drives Skimmer Arm to Remove Floating Scum

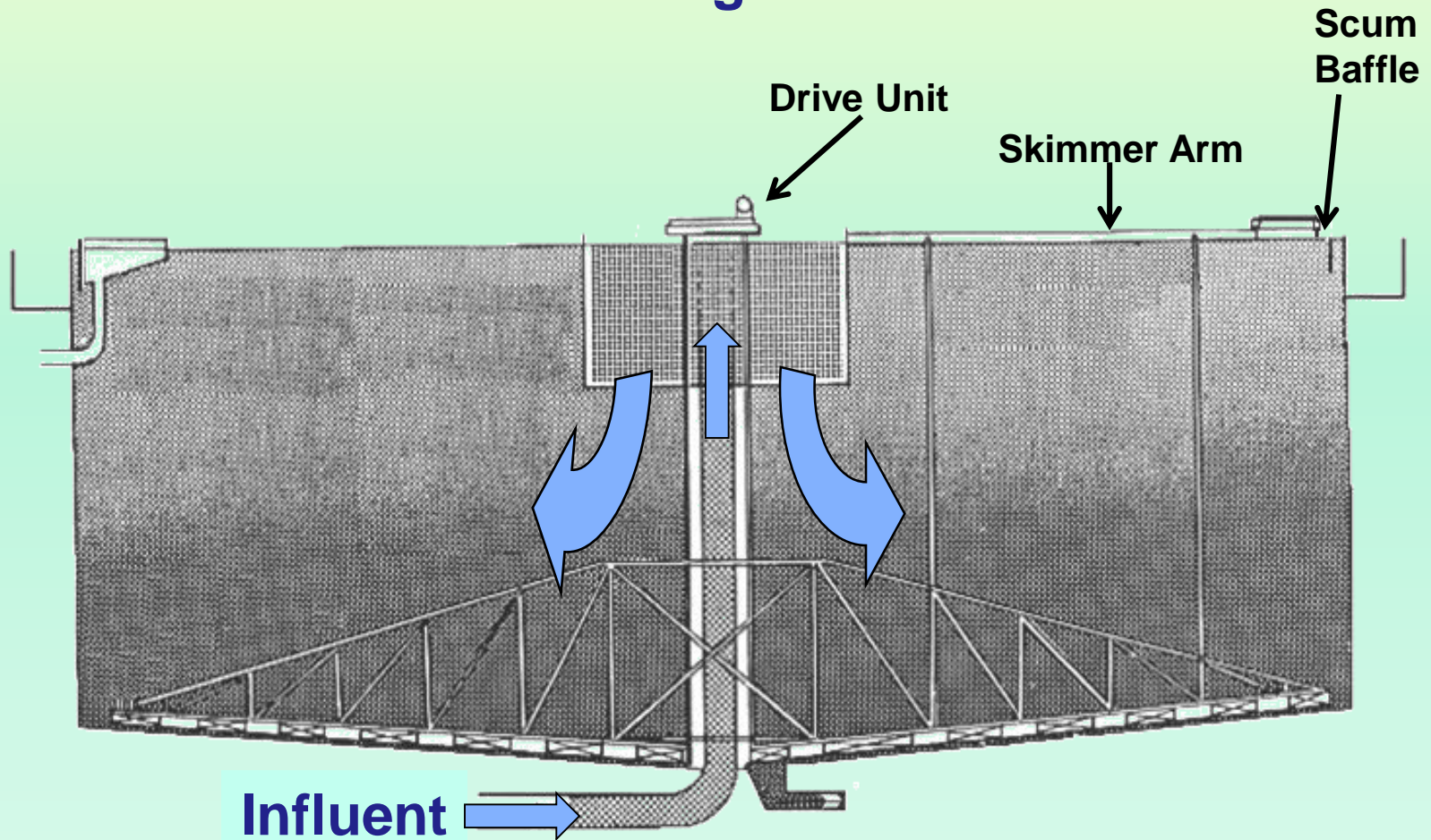

Circular Clarifier

Drive Mechanism Also Drives Skimmer Arm to Remove Floating Scum

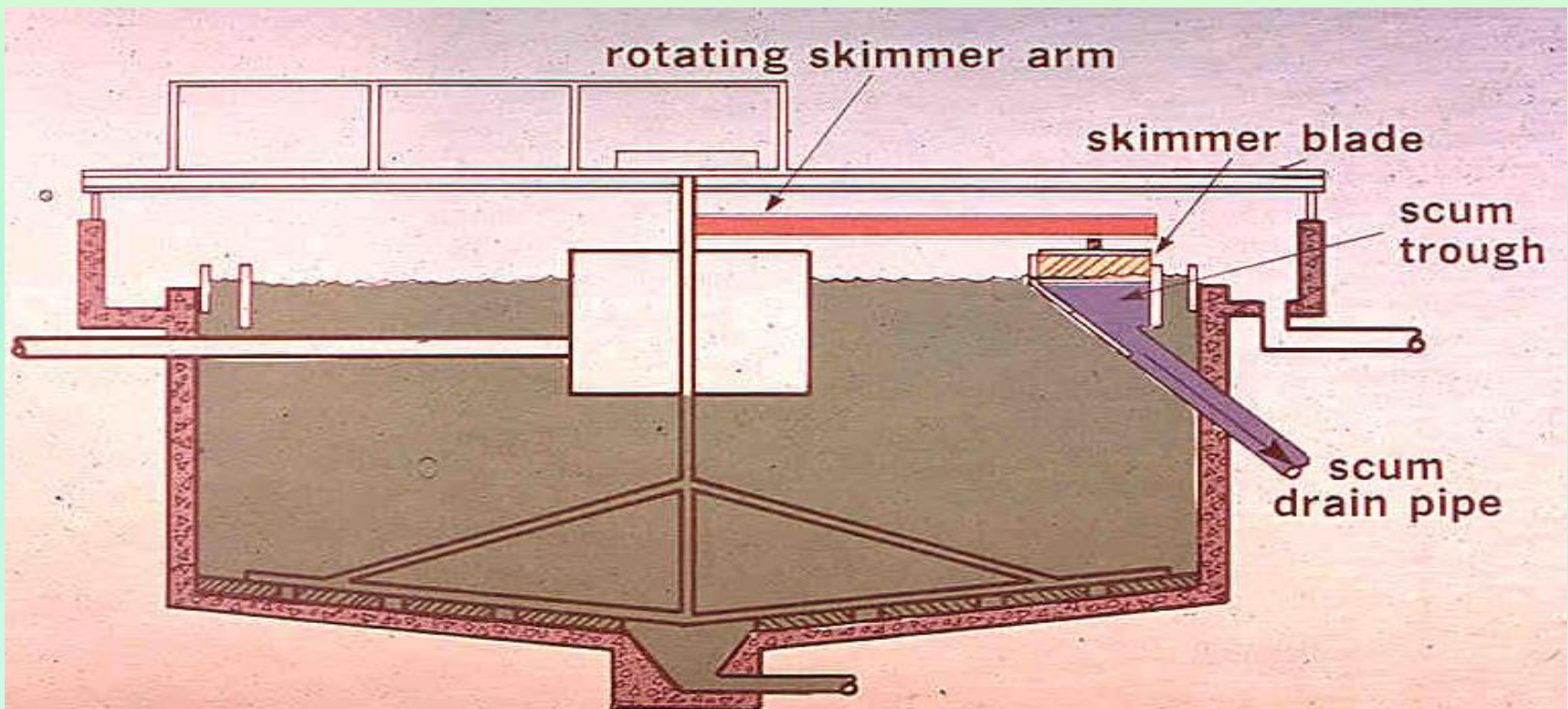

Circular Clarifier

Drive Mechanism Also Drives Skimmer Arm to Remove Floating Scum

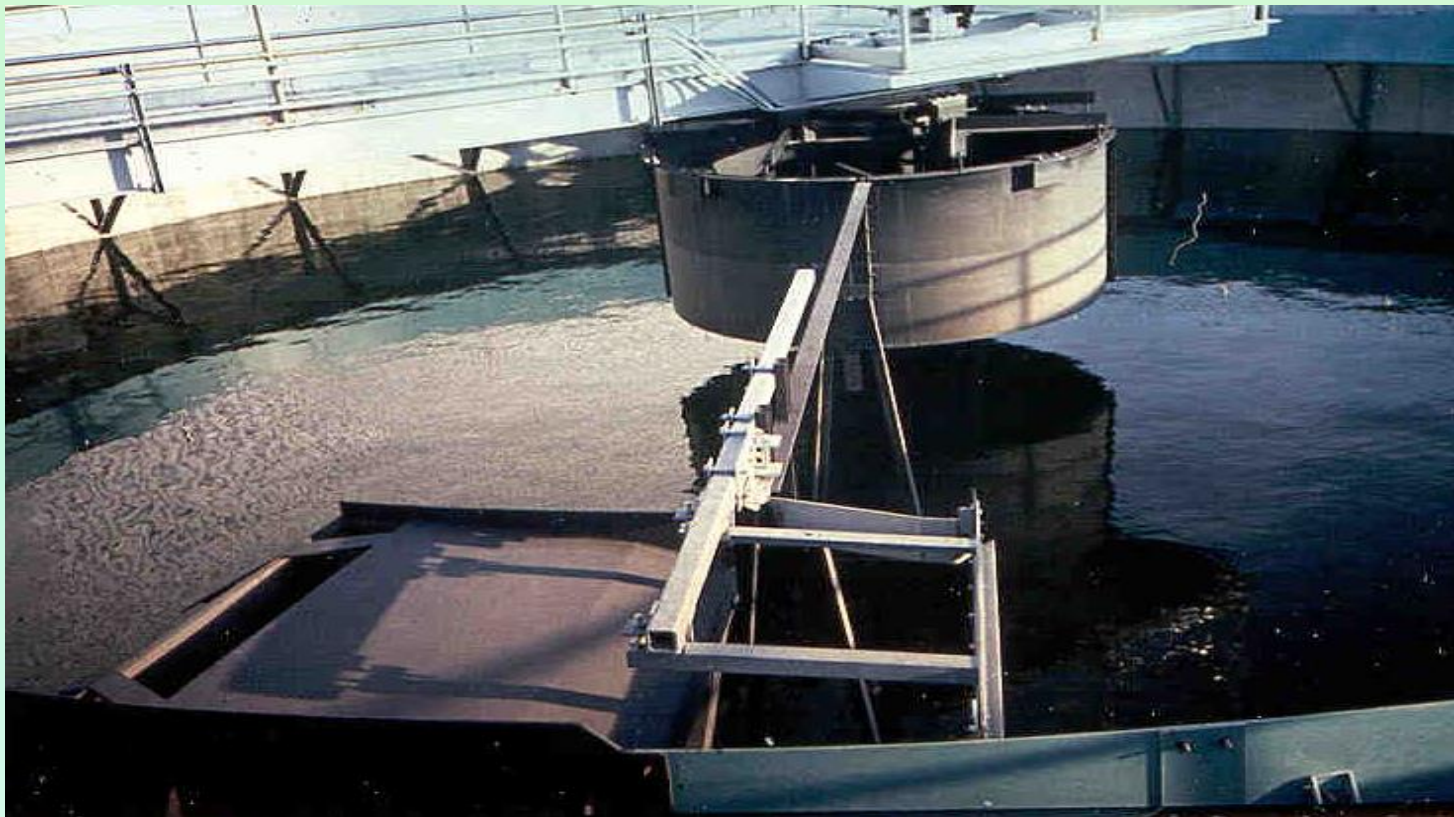

Circular Clarifier

Drive Mechanism Also Drives Skimmer Arm to Remove Floating Scum



Circular Clarifier

Drive Mechanism Also Drives Skimmer Arm to Remove Floating Scum

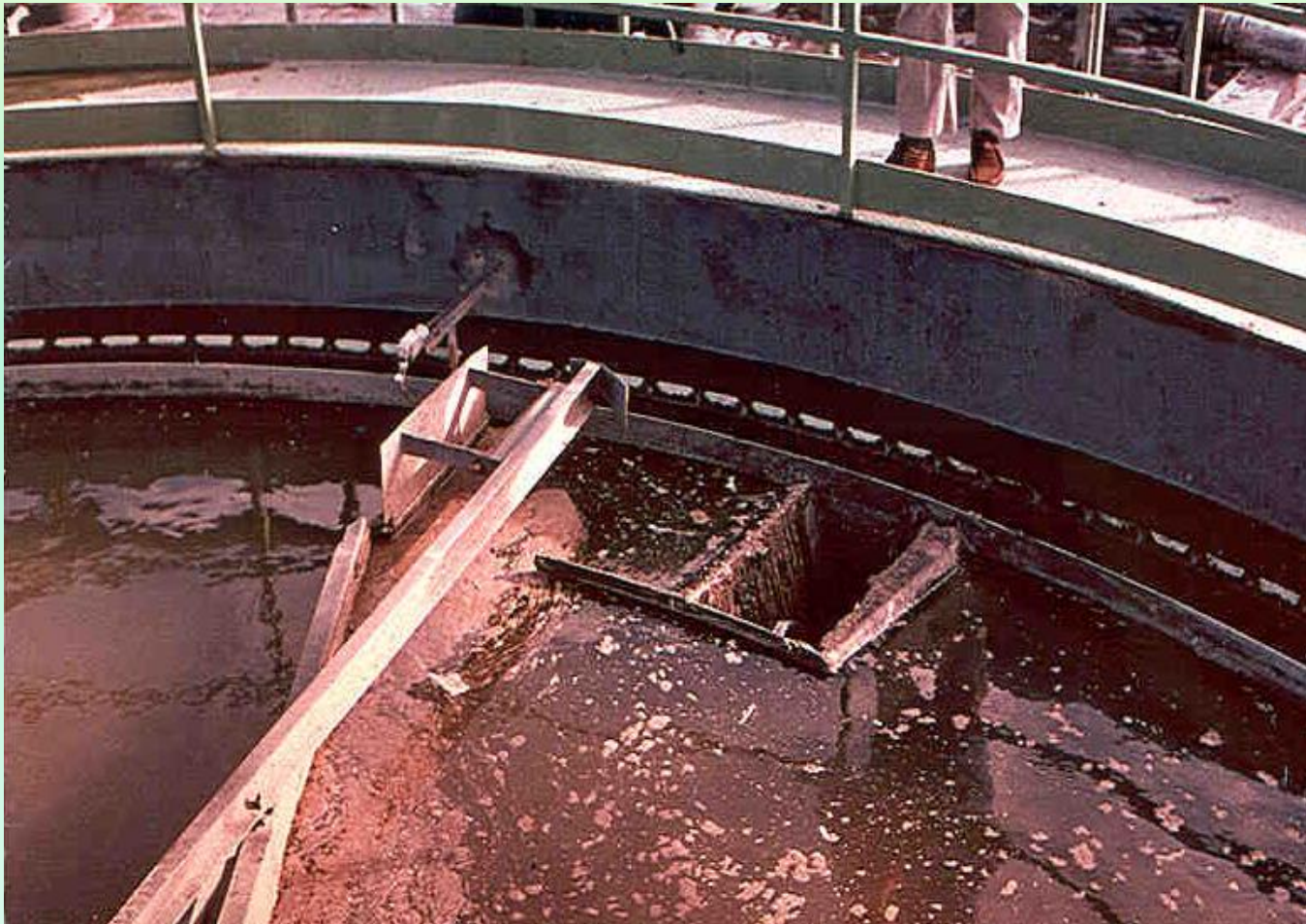

Circular Clarifier

The Water Flows to the Effluent Weir Around the Circumference of the Clarifier

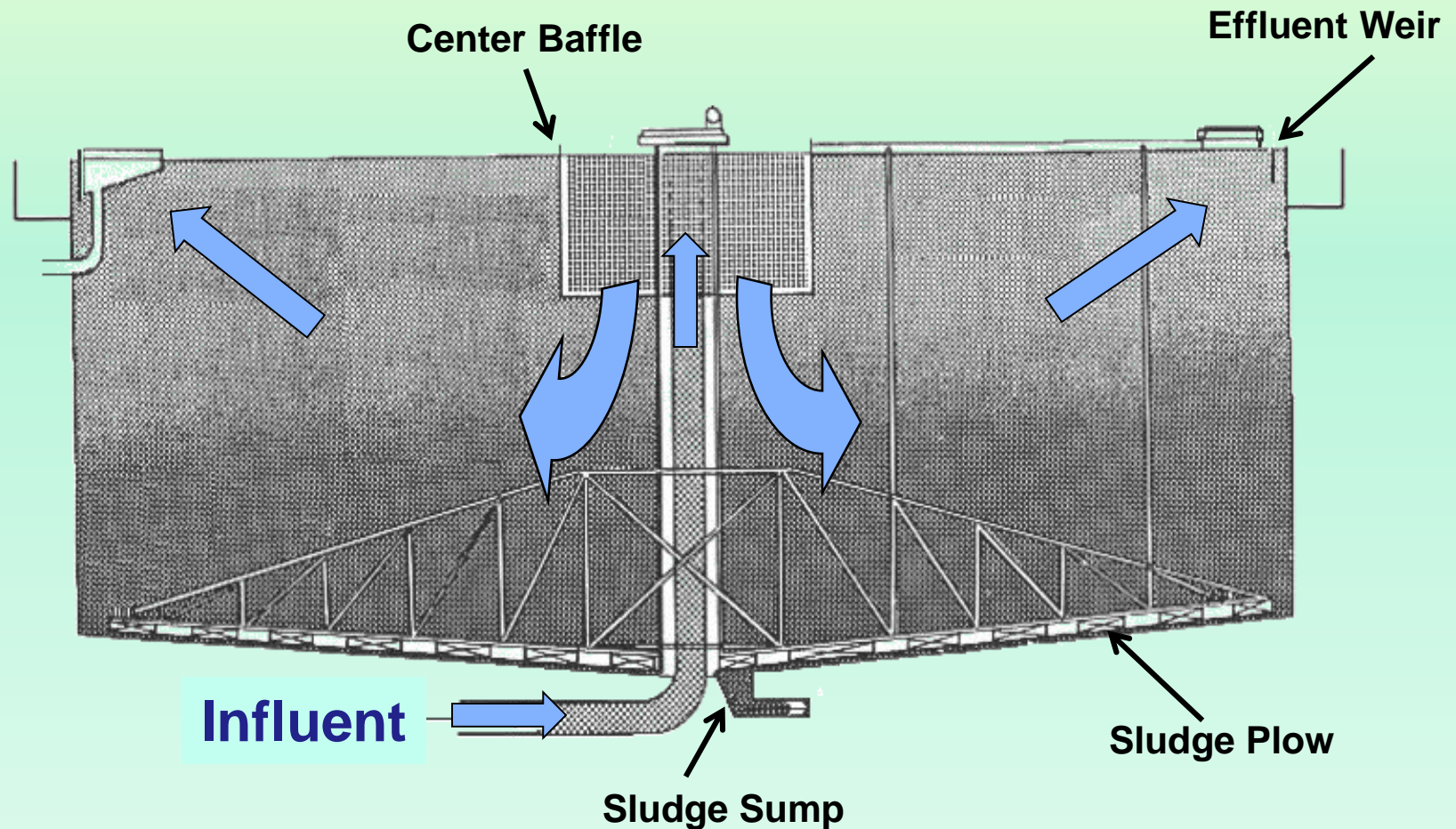

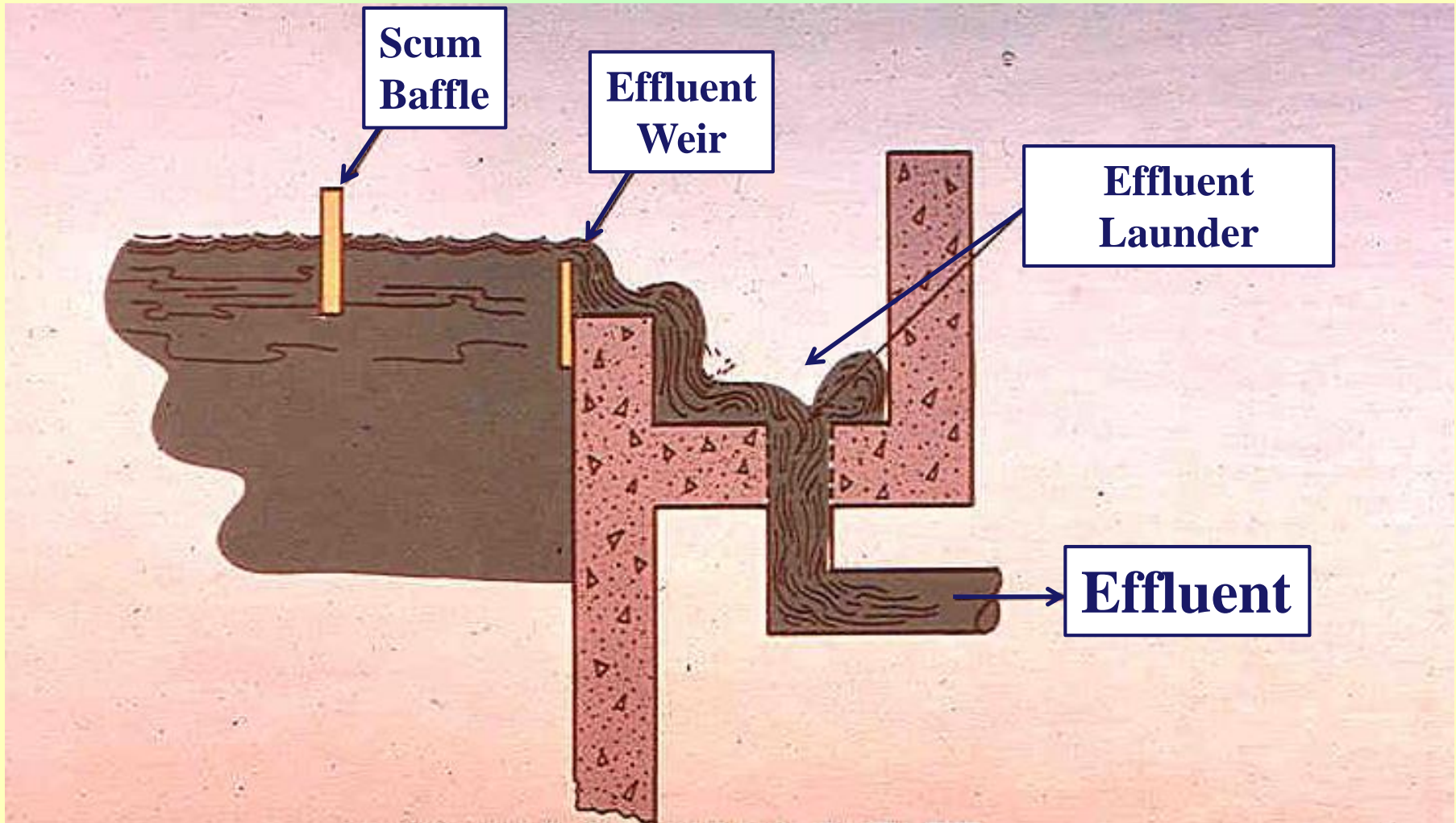

Circular Clarifier Outlet

The Launder and Weir May Be

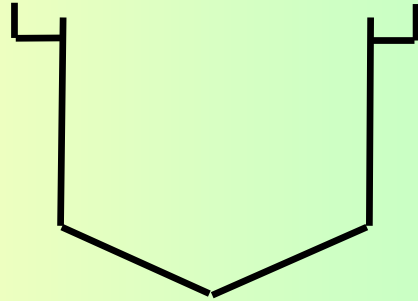

1

**Outer
Wall**

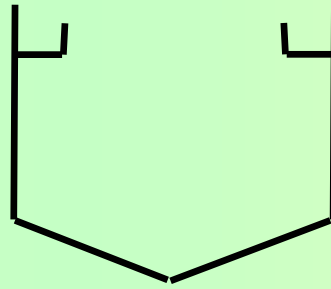

2

**Inner
Wall**

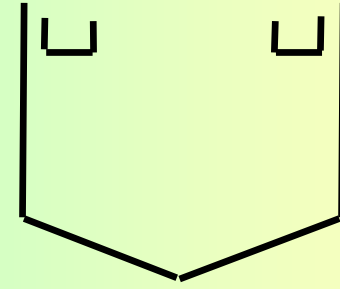

3

**Suspended
In Clarifier**

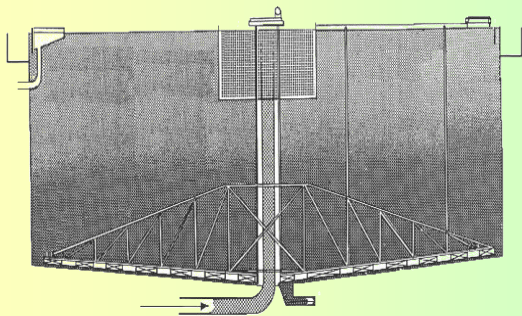

Effluent Launder/Weir Inside Clarifier (#2) Can Create Water Current

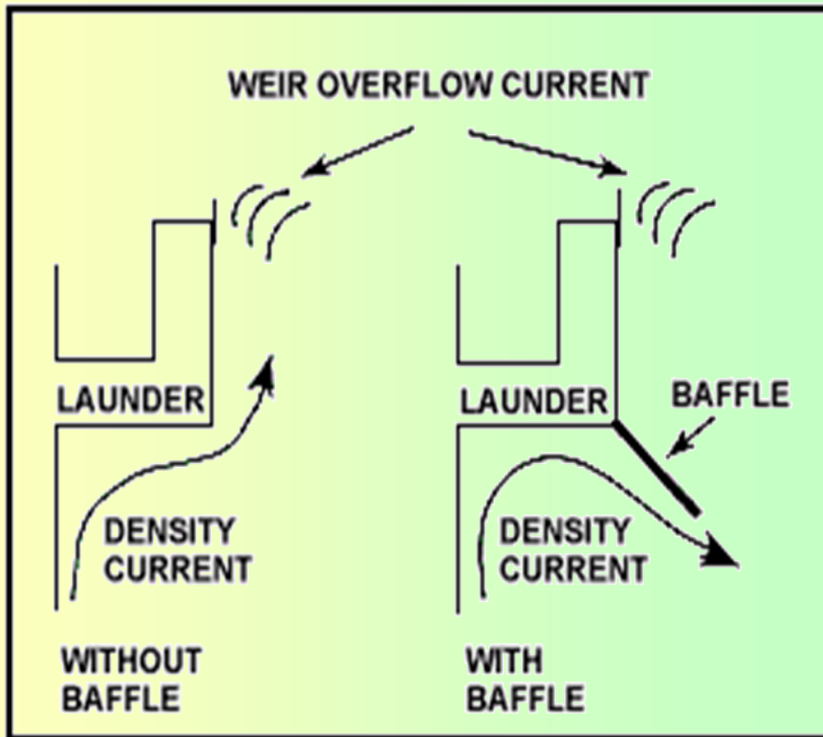

- **Loss of solids over weir.**
- **Baffles used to redirect & slow water currents.**

Other Clarifier Baffles

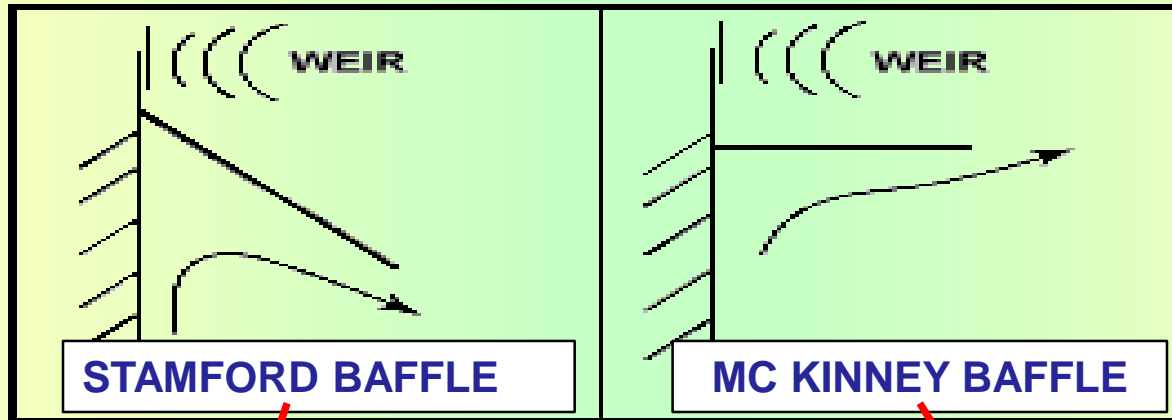

Clarifier Short Circuiting

- **Missing or poor effluent baffling**
- **Uneven effluent weirs**
- **Plant growth or thrash in effluent weirs**
- **Temperature stratification between influent & clarifier water temperatures.**

Clarifier Variations



Clarifier Variations

Rectangular Tank

Circular Sludge Collection and Skimming



“Squirqular” Clarifier



Clarifier Variations



Peripheral Feed
Peripheral Discharge

Clarifier Variations



**Peripheral
Feed**

**Center
Discharge**



Clarifier Variations

Radial Discharge

Peripheral Feed



Clarifier Variations

Tow Bro Clarifier



Clarifier Variations

Spiral Sludge Collector

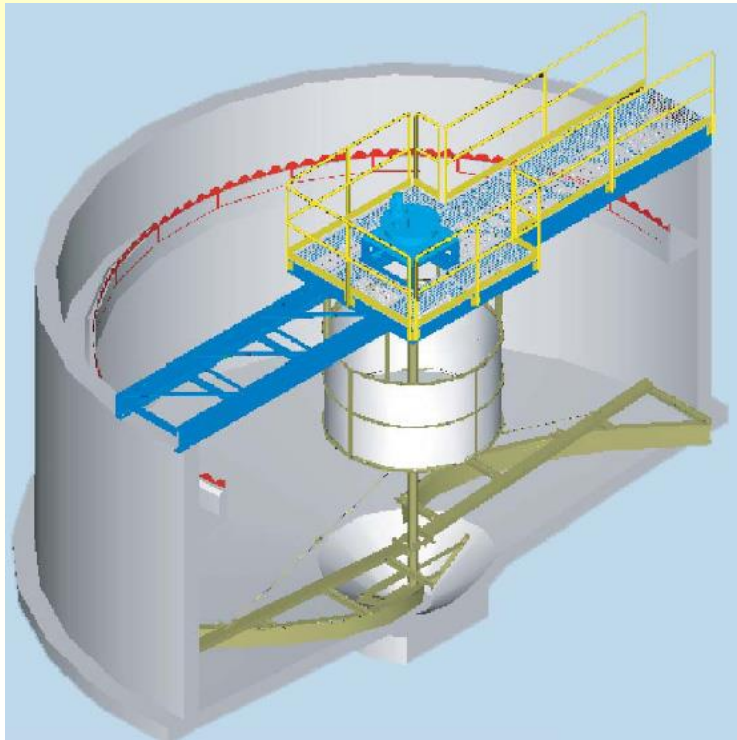

Clarifier Variations

Telescoping Valves for RAS Return

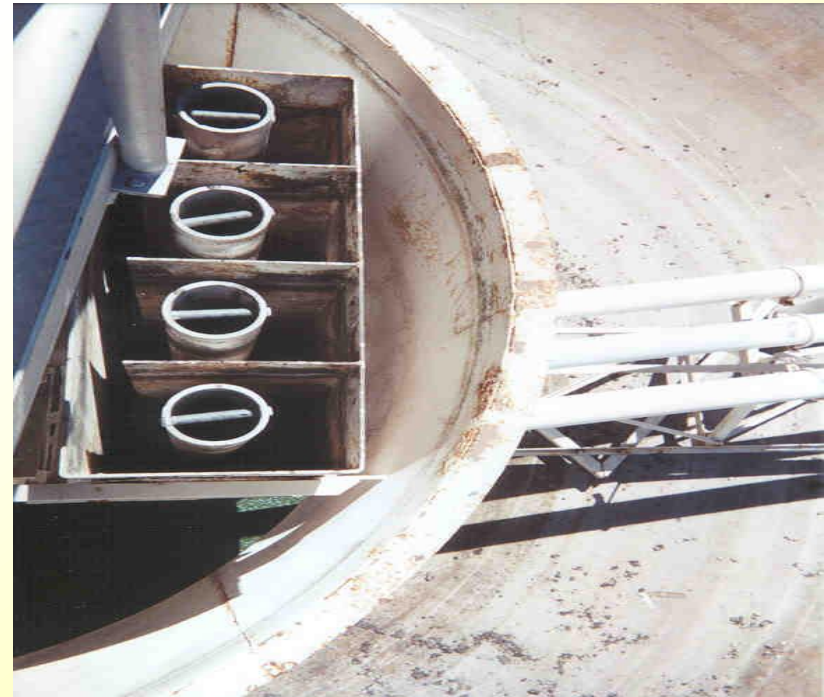

Clarifier Variations

Many Others

Each Designed to Address Particular Concern

Clarifier Operation

Routine Inspection & Maintenance

Drive Mechanism

Lubrication (Manufacturers Specs.)

Observe Proper Operation (2/Day)



Clarifier Operation

Sludge Judge Daily (Each Shift)

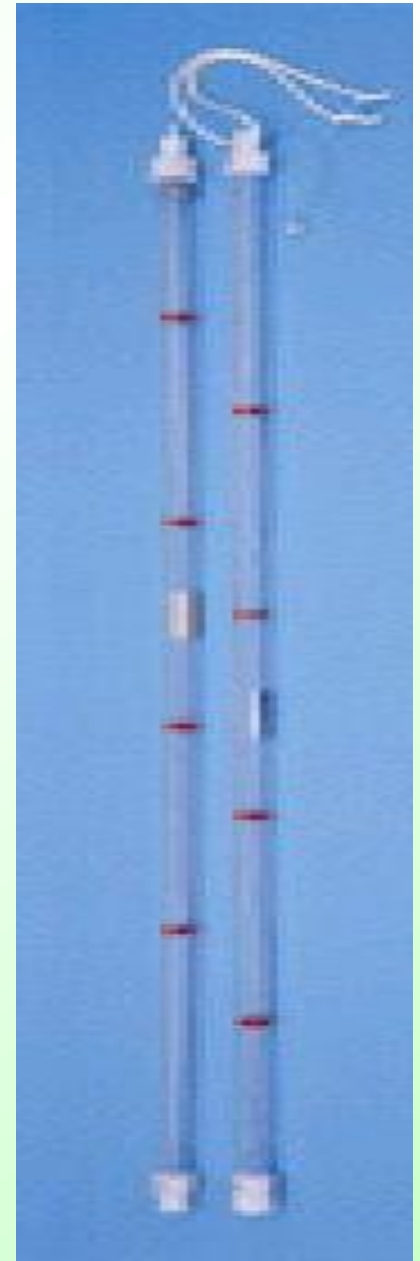

Clarifier Operation

Rectangular Clarifiers

Sludge Collection System

Operating Smoothly

Floating Sludge

Frequent Shear Pin or Breaker Failure

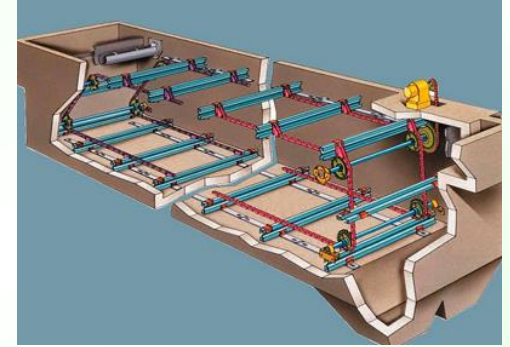

Circular Clarifiers

Skimmer/Sludge Collector

Operating Smoothly

Scum Trough Plugged

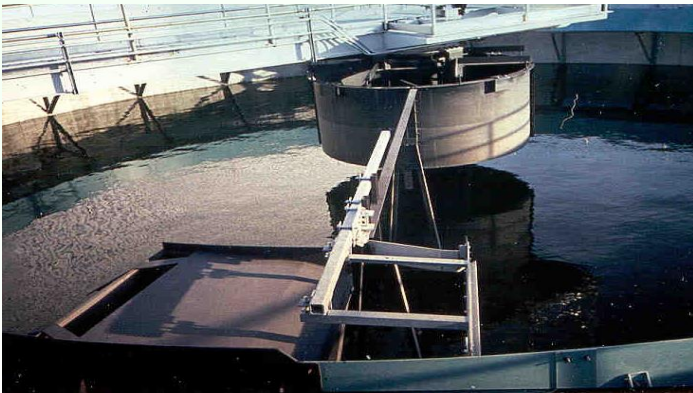

Clarifier Operation

Cleaning

Weirs – Launder - Center Well

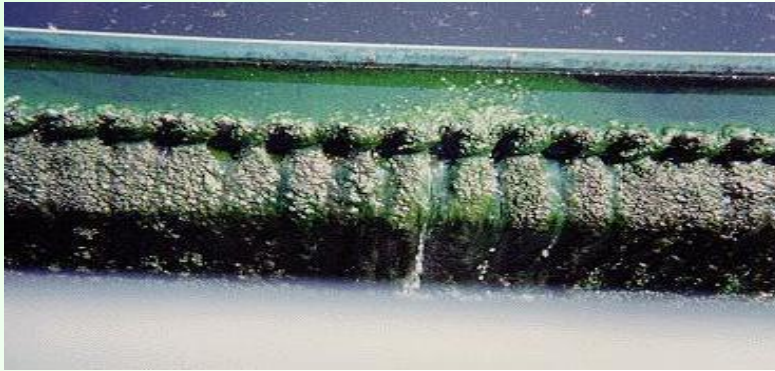

Clarifier Operation

**The
Hard
Way**



**The
Easy
Way**



Clarifier Operation

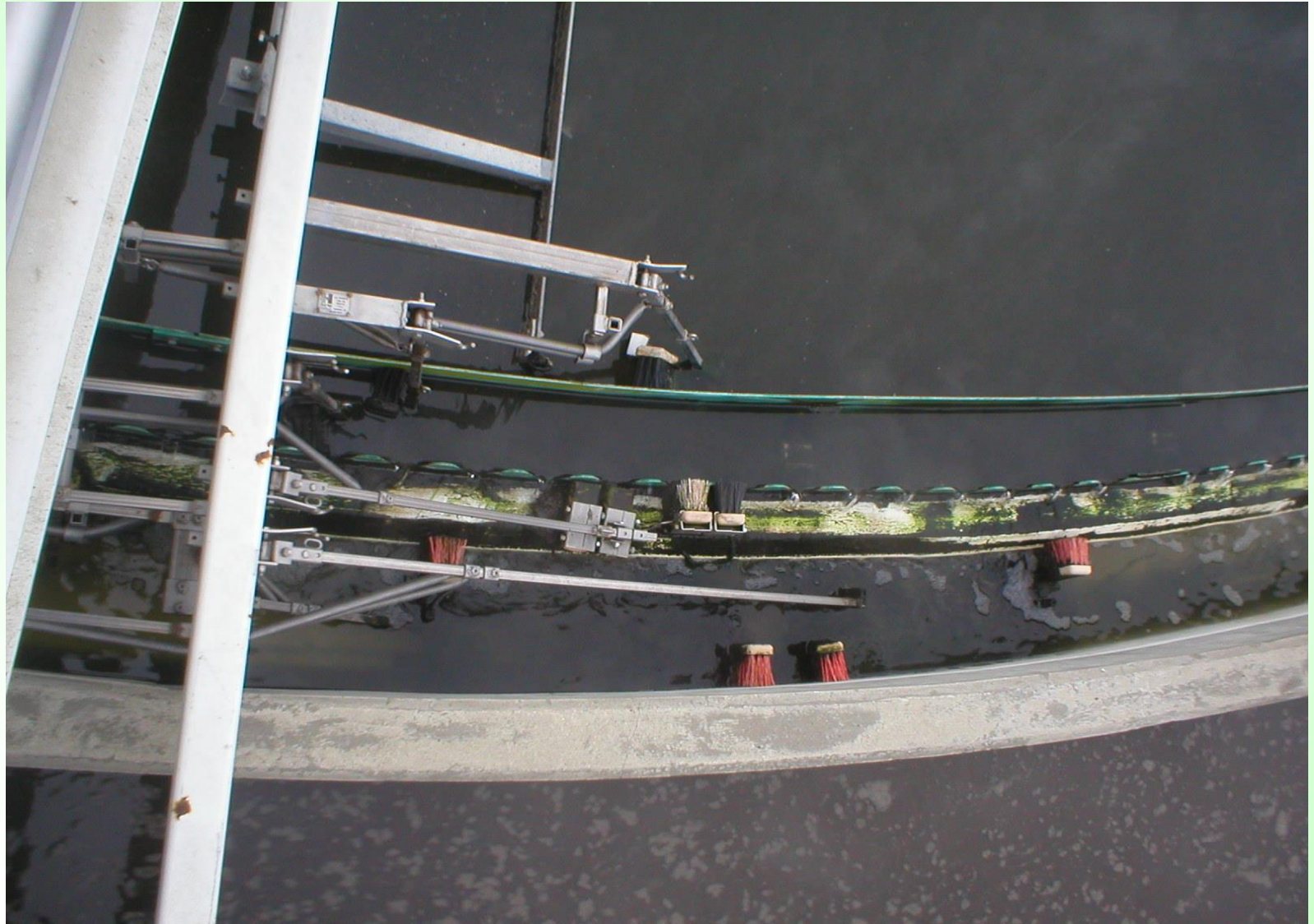

Clarifier Operation

Limit Growth ?



Clarifier Operation

Limit Growth ?

Covers Block Sunlight Limits Algae Growth



Clarifier Operation

Limit Growth ?

Covers Block Sunlight Limits Algae Growth



Provides Cold Weather Protection

Clarifier Operation

Monitoring for Short Circuiting

Visual Observation

Flow Over Weir

Solids Over Weir



Dye Testing



Clarifier Operation

Routine Inspection & Maintenance

Sludge Judge Daily (Each Shift)

Cleaning

Monitoring for Short Circuiting

Clarifier Operation

**Also Includes
Calculating and Monitoring Loading**



**Detention Time
Surface Overflow Rate
Weir Overflow Rate
Solids Loading Rate**

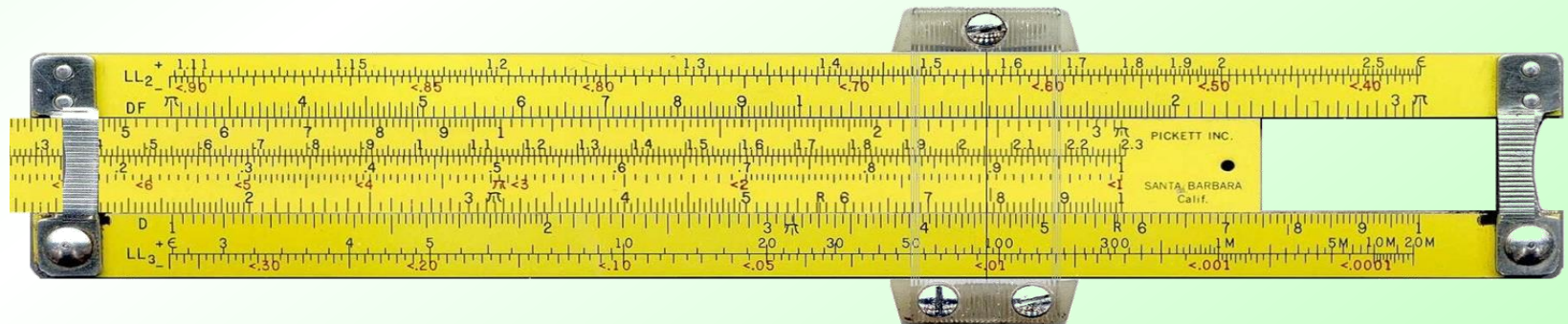
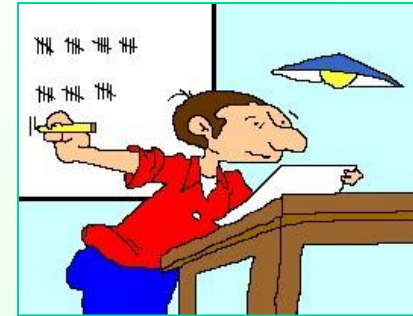

CLARIFIERS

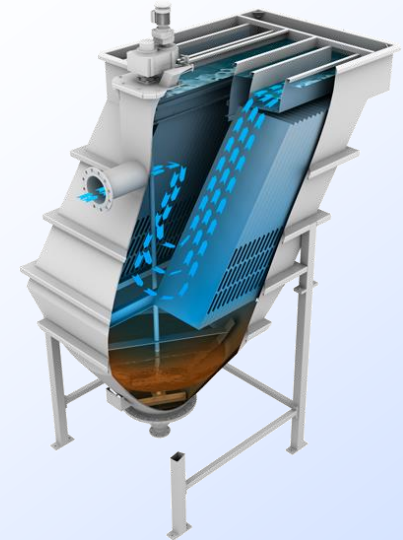
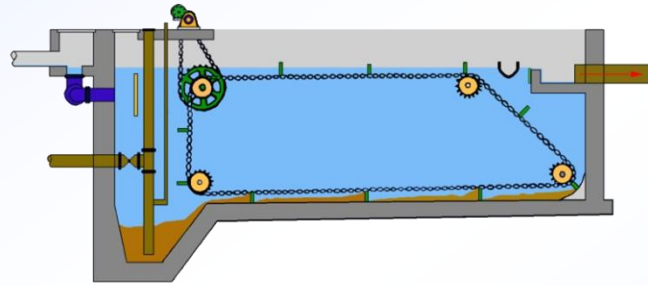
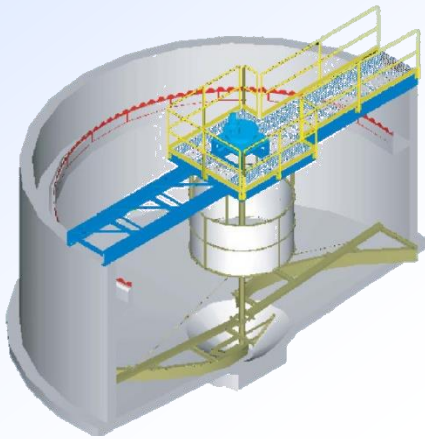

Prepared By
Michigan Department of Environmental Quality
Operator Training and Certification Unit