

Crushing Optimizing the Process

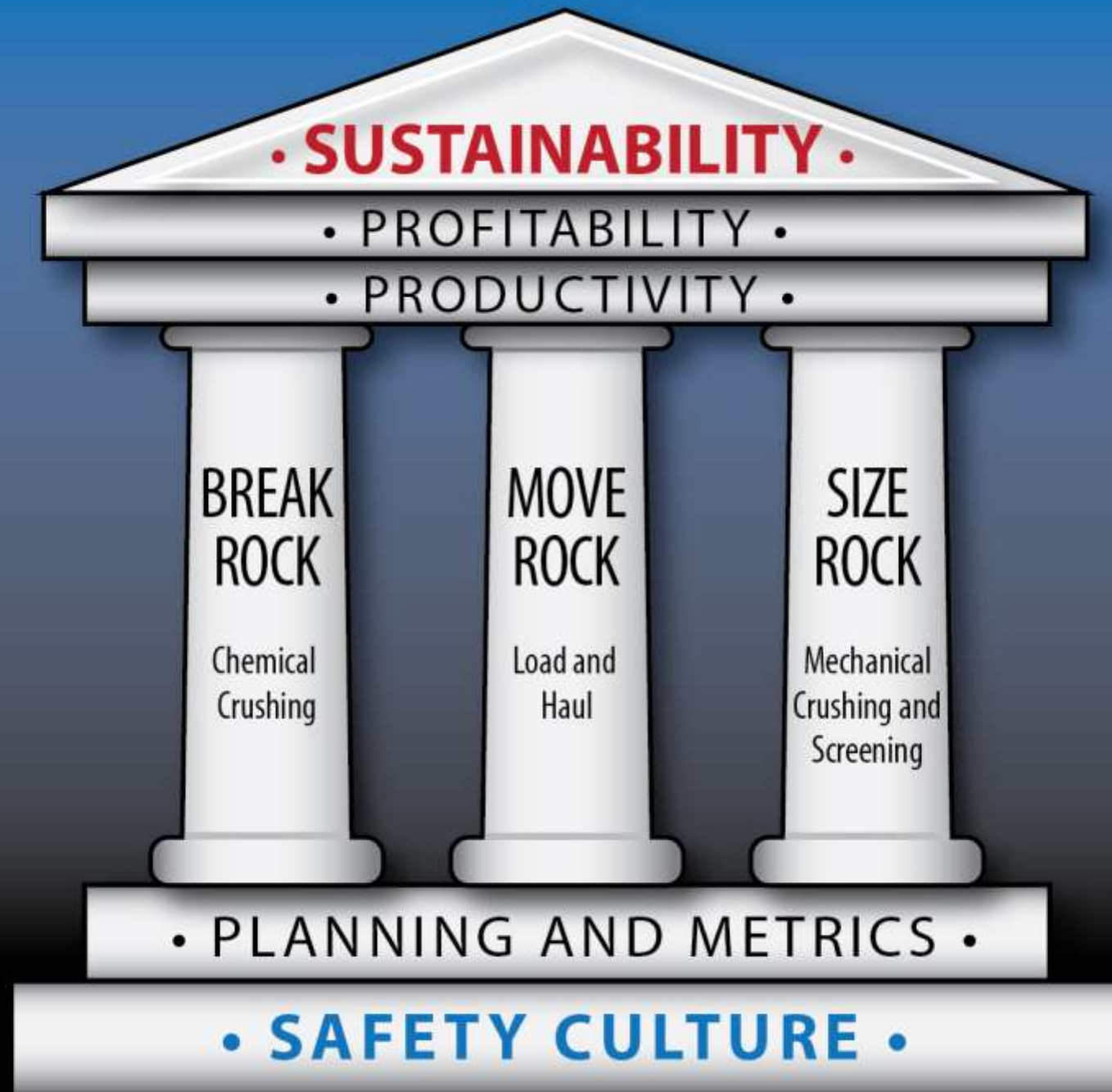

Improving Processes. Instilling Expertise.



Optimizing the Process

- Methods to combine and simulate technical and economic performance
- Optimum crushing plant performance is difficult to achieve due the process characteristics. Different compared to all other industrial processes.
- Optimizing method for best performance
- Partly implemented in PlantDesigner 10

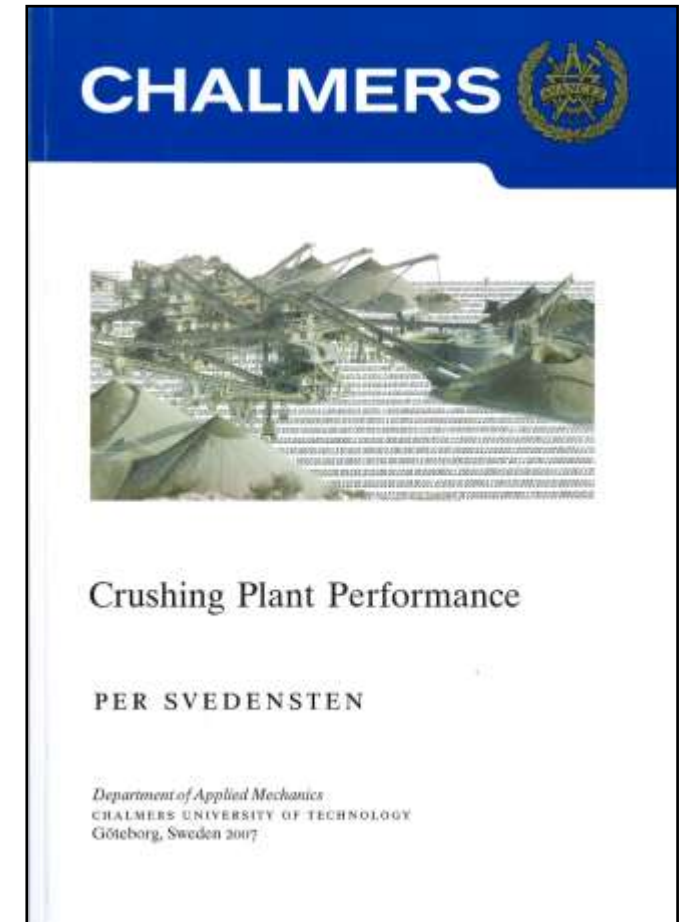

Crushing Plant Optimization

- Point of interest
 - Crushing stage
 - Crushing plant
 - Quarry Process
- Today:
 - Optimize the feed
 - Optimize the process

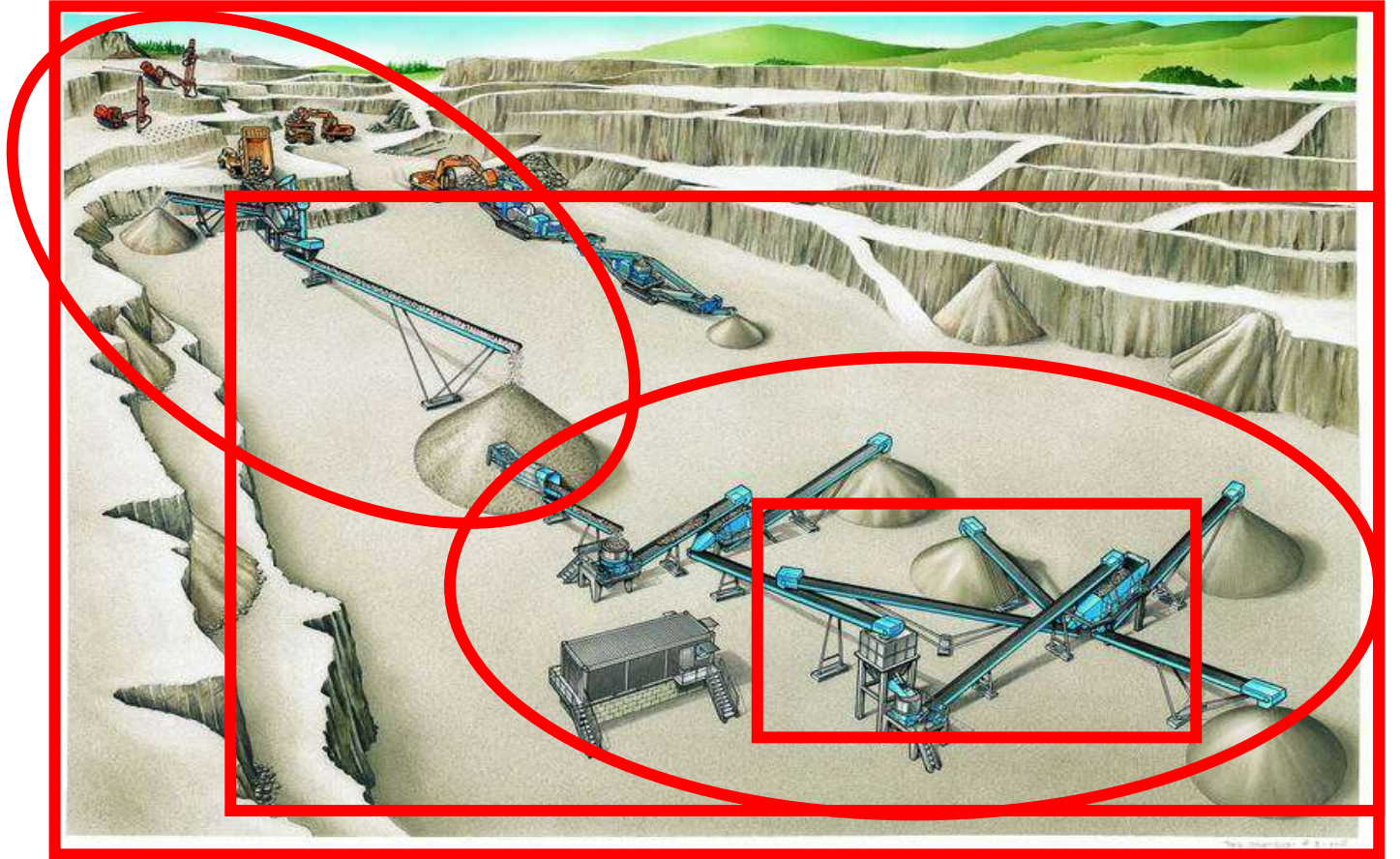

Optimization of a Final Crushing Stage

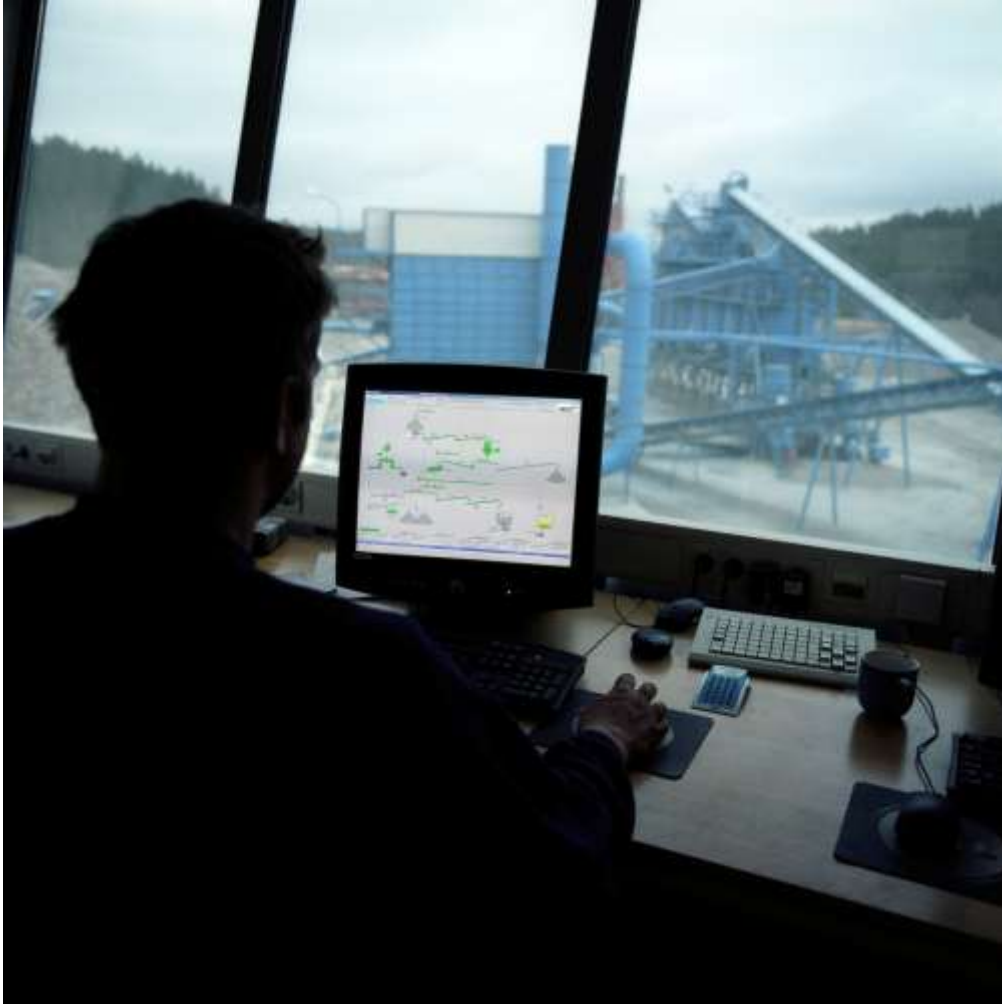

- Who is control of your process performance?
- What tools have been provided to make the production efficient?

- Maximize crusher yield
 - Production of valuable products
 - Efficient production of current product demands

- *Crusher Performance Map* will help guide the crusher operator

Optimization of a Final Crushing Stage



- This method applies to other crushers where a control variable is available
- The crushers are the last size reduction stage in the value chain.
- Over crushing is common.
- The connection between crusher setting and yield is often unknown
- The rock cannot be repaired.
- We need to control the crusher carefully.

Optimization of a Final Crushing Stage

Planning

Sampling

Analysis

Optimization



- Optimization of one parameter (CSS) can be done by sampling and analysis
- The invested time and lost production will quickly be repaid by increased productivity
- Combine product yield and economic aspects
- This can be done by taking samples and making the analysis in MS Excel

Optimization of a Final Crushing Stage

Planning

Sampling

Analysis

Optimization

- Run the crusher at different settings
- Take at least one sample at each setting. (Multiple samples are often useful)
- Special Attention to Safety when taking samples!!
- Position of point where samples are taken.
- Ensure that the conveyor will not start by accident.



Optimization of a Final Crushing Stage

Planning

Sampling

Analysis

Optimization

- Particle Size Distribution Plots
- If taking single samples on each CSS the risk of getting inconsistent results might make the graph look strange.
- Impossible to determine optimum setting by only using particle size distribution graphs

Particle Size Distribution for different CSS

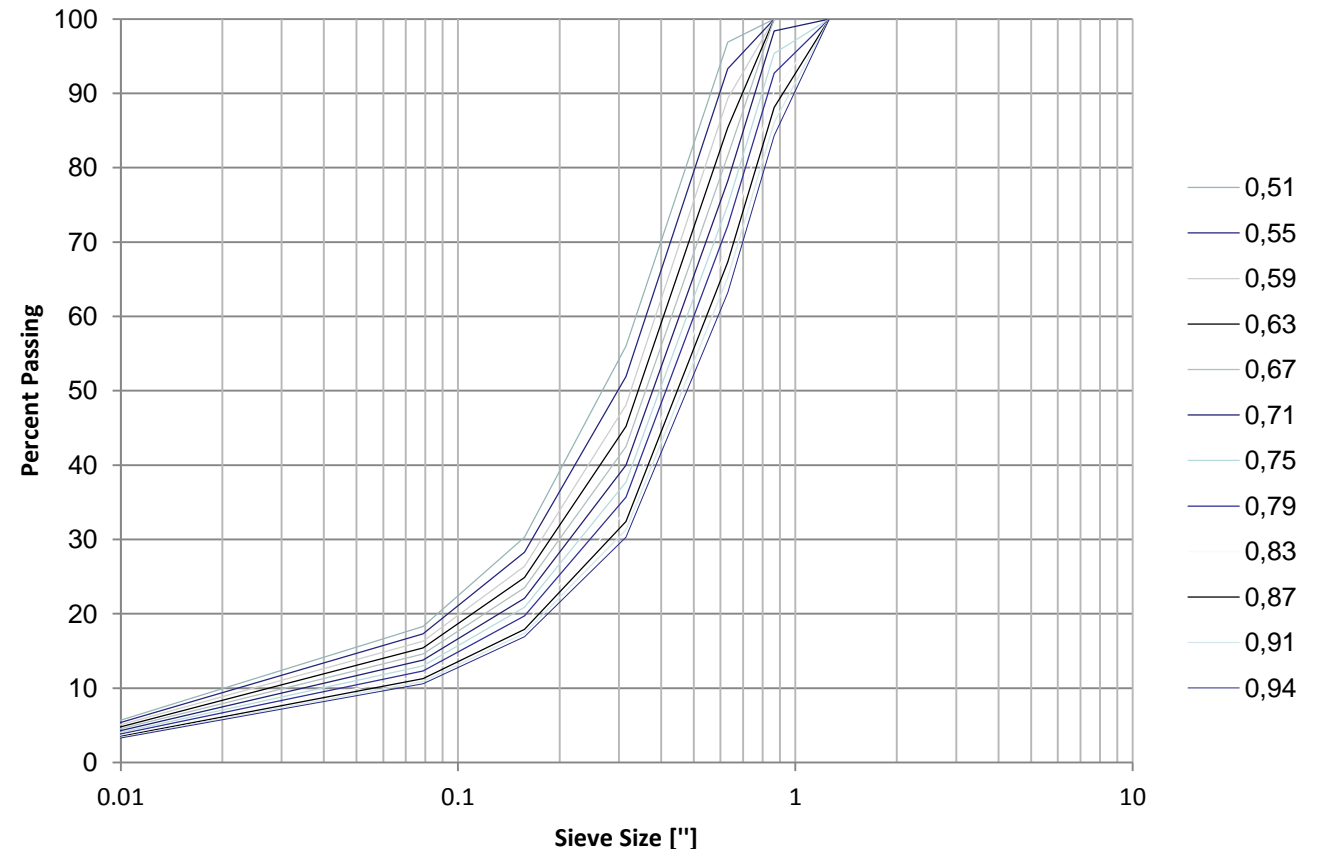

Optimization of a Final Crushing Stage

Planning

Sampling

Analysis

Optimization

- If taking single samples on each CSS the risk of getting inconsistent results might make the graph look strange.
- Impossible to determine optimum setting by only using particle size distribution graphs

Capacity and CSS

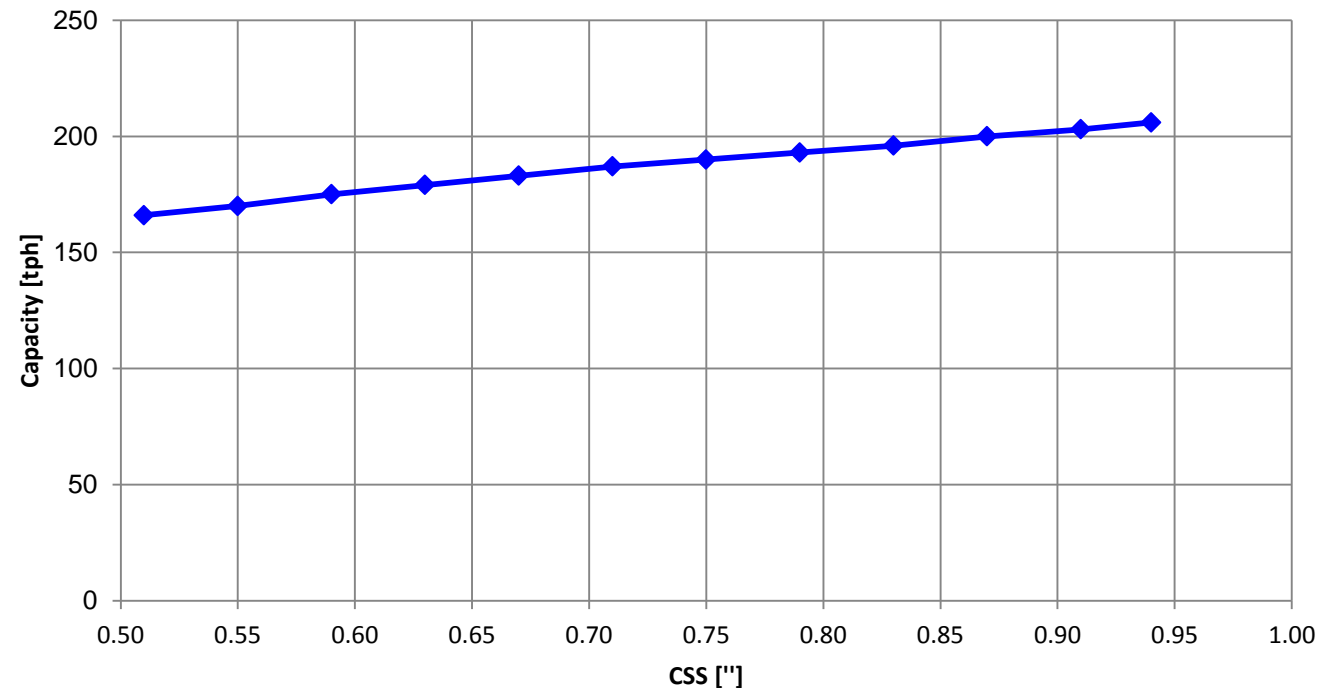

Optimization of a Final Crushing Stage

Planning

Sampling

Analysis

Optimization

- Combine the particle size distribution and capacity.
- Percentage of final product times the capacity gives the production capacity of each product.

- Example 0.08''-0.16'' mm at CSS 0.79'':

- Percentage of crusher production
- $20\% - 11\% = 9\%$
- Crusher capacity
- 193 tph

- Total Production:
- $193 \text{ tph} \times 9\% = 17 \text{ tph}$

Capacity and CSS

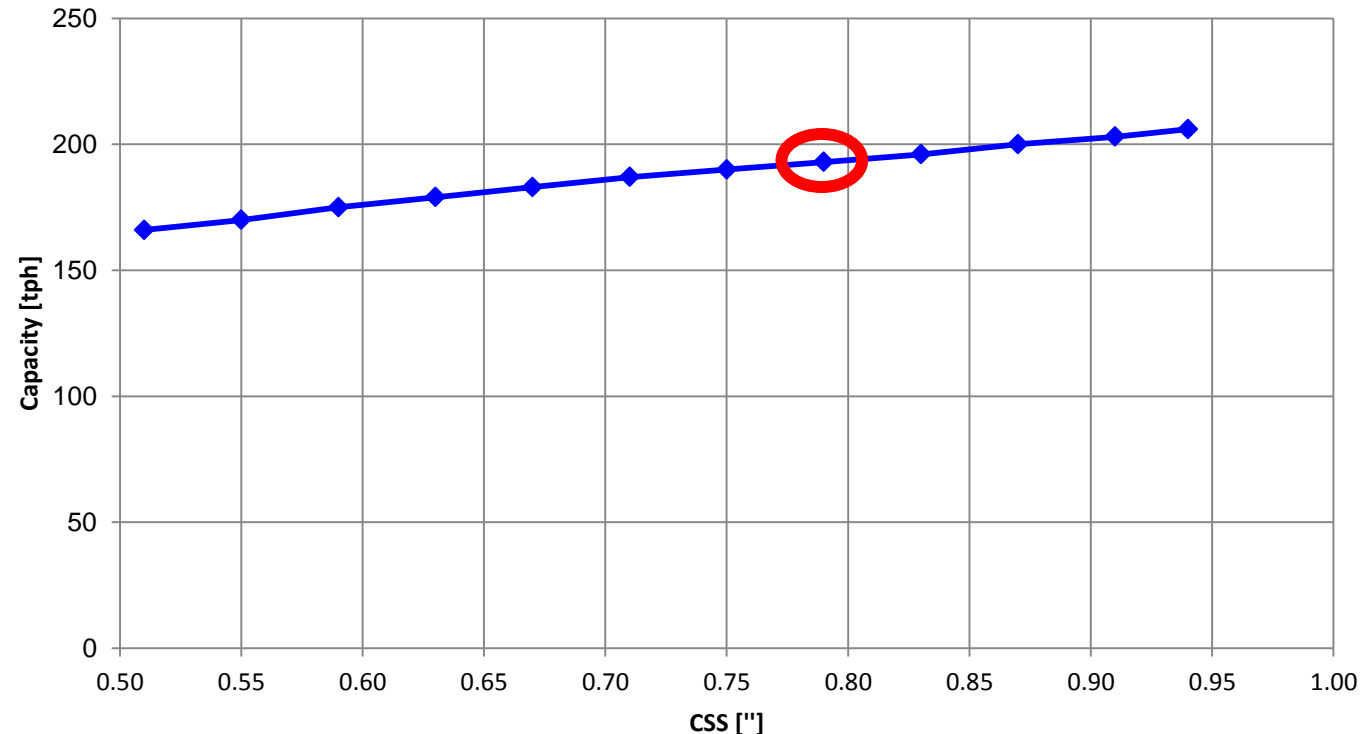

Optimization of a Final Crushing Stage

Planning

Sampling

Analysis

Optimization

- Entering all the values into MS Excel makes this easy to get production capacities.
- Still difficult to determine the optimal setting

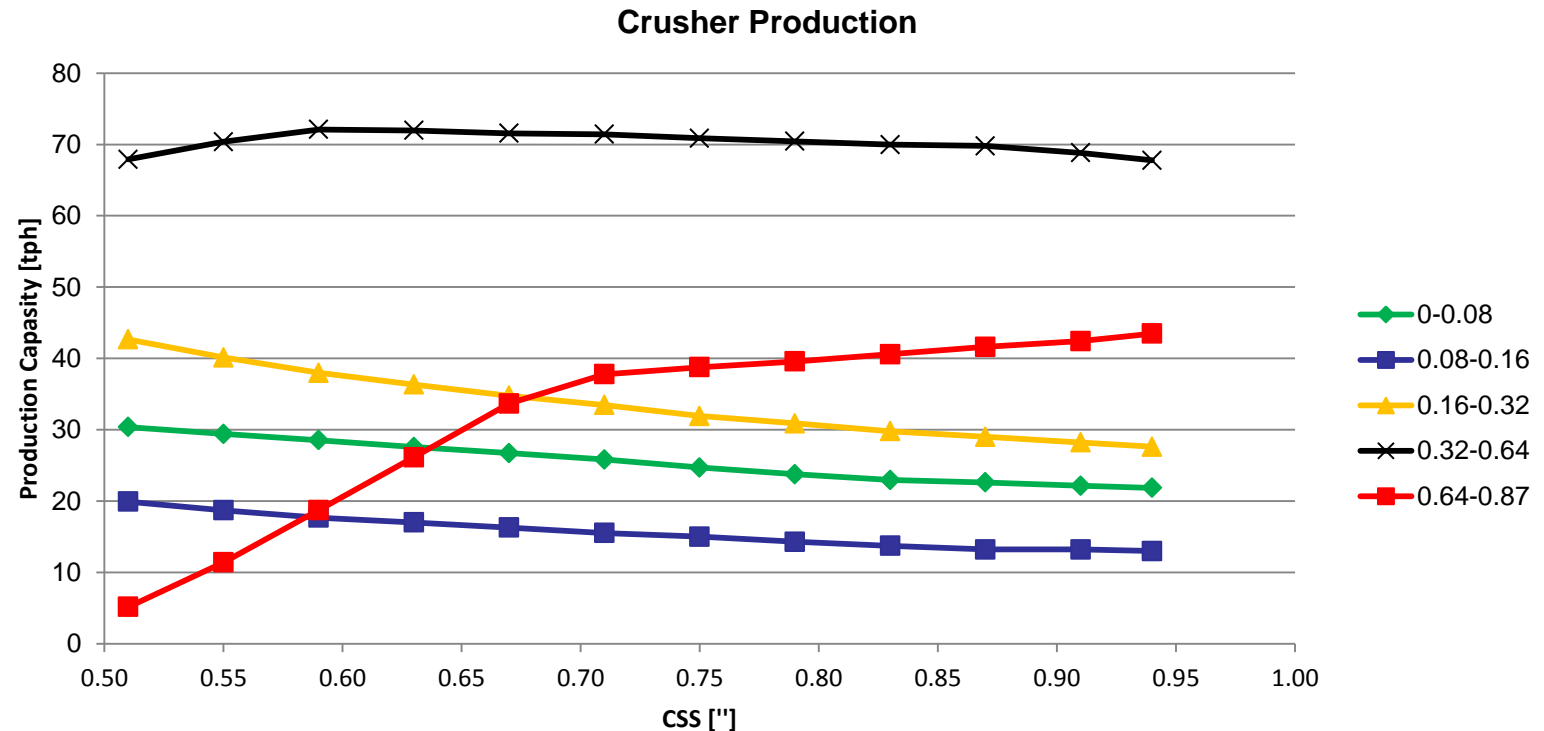

Optimization of a Final Crushing Stage



Crusher Yield

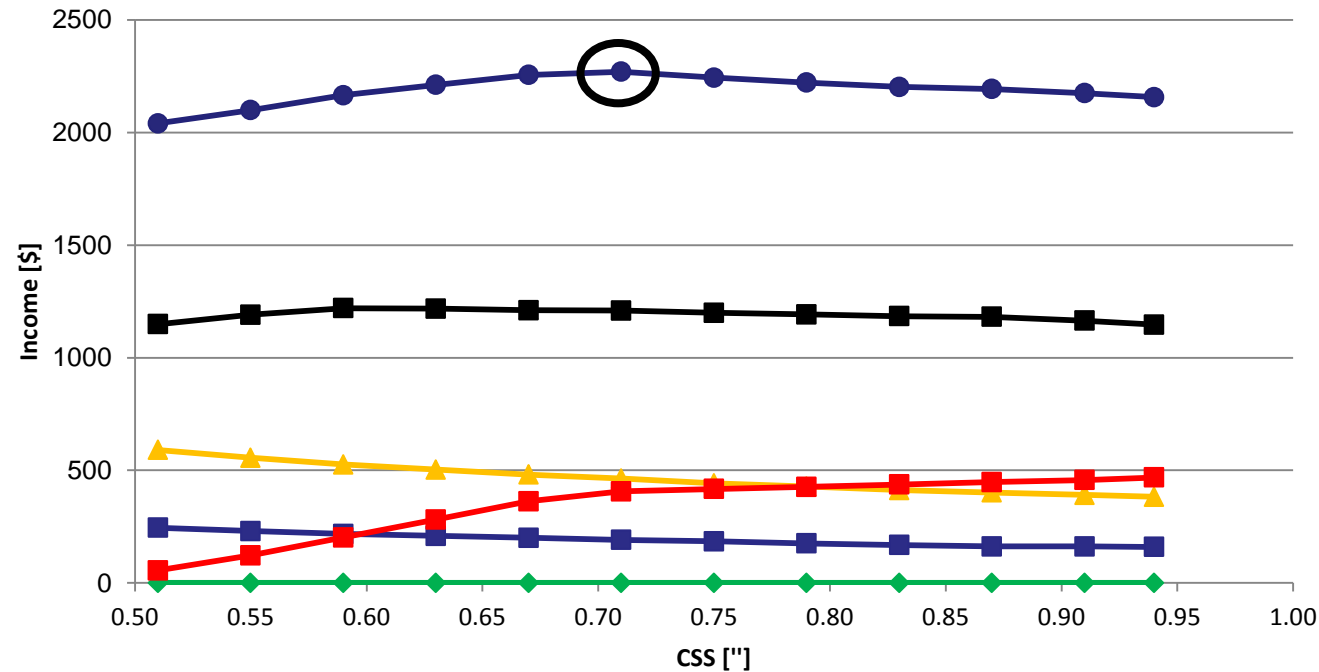

- Use the price* per ton for all products:

- 0-0.08": \$ 0 (by-product)
- 0.08-0.16": \$ 12.30
- 0.16-0.32": \$ 13.85
- 0.32-0.64": \$ 16.90
- 0.64-0.87": \$ 10.80

- Make an income graph by combining prices with capacity



*All prices are estimates based on publicly available data

Optimization of a Final Crushing Stage

Planning

Sampling

Analysis

Optimization

- What difference does it make?
- Running the crusher 0.08" off:
 - Decrease the profit by 58.5 \$/h
 - Running the crusher at 1600 hours per year:
 $58.5 * 1600 = \$93600$

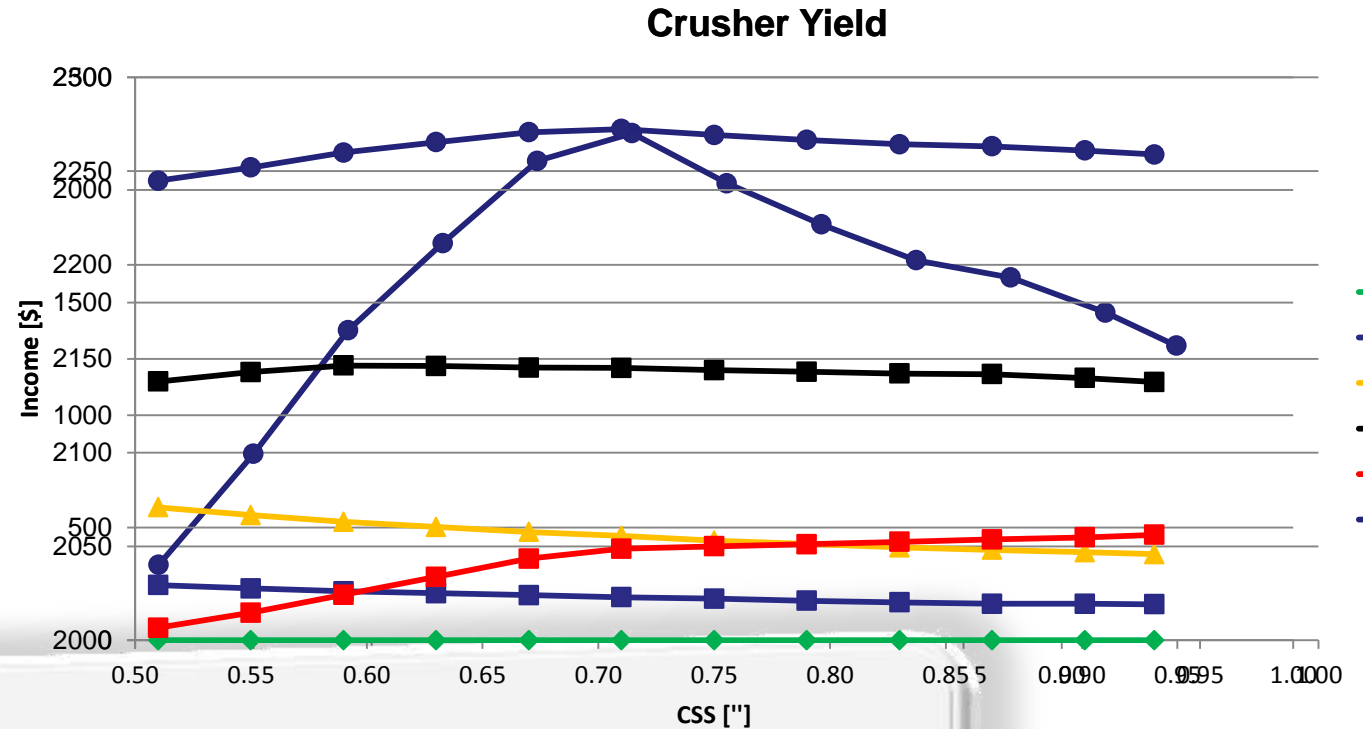

Optimization:

The effort put in to optimization will repay itself quickly

Crusher Performance Map

Planning

Sampling

Analysis

Optimization

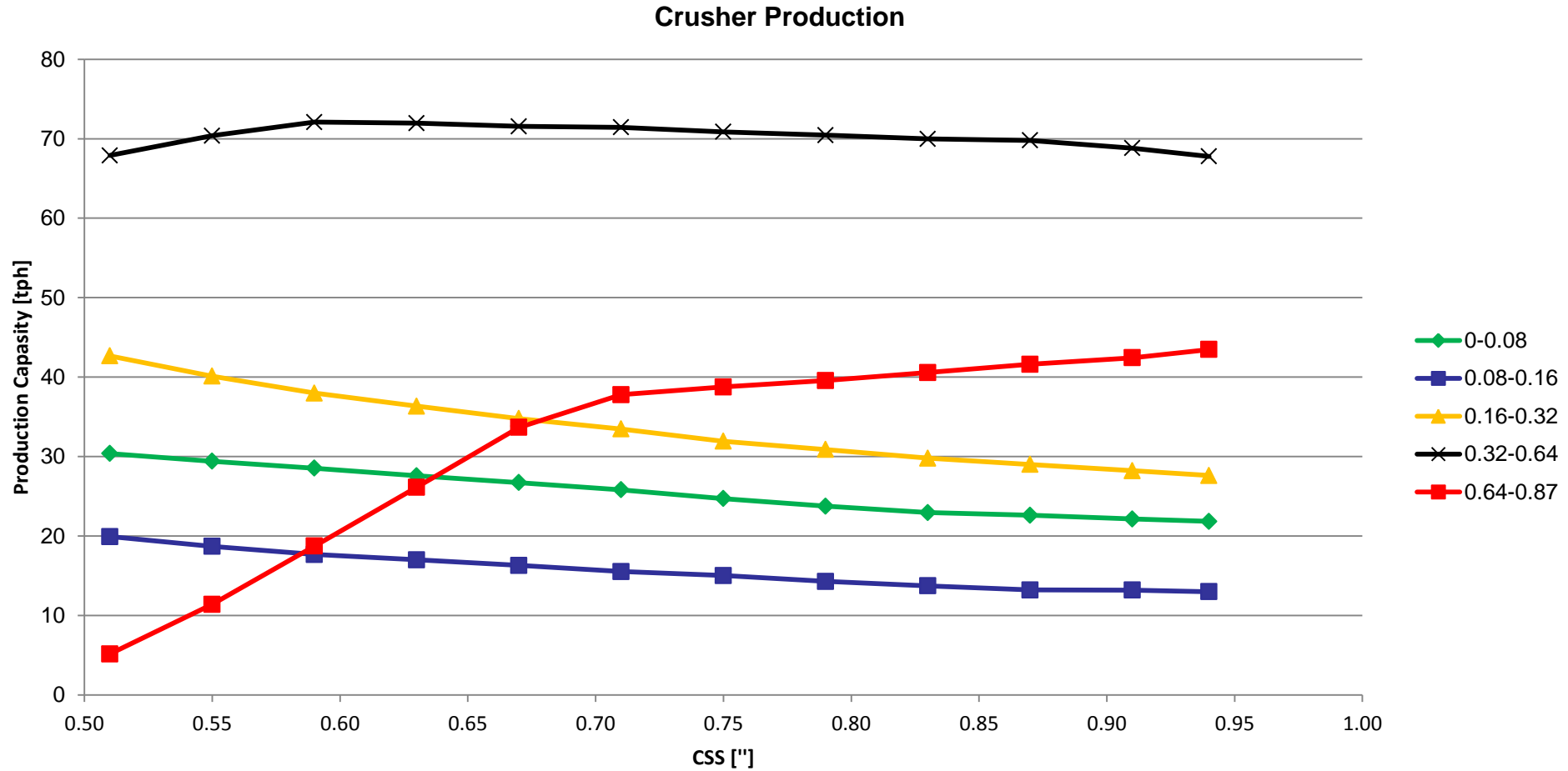

Crusher Performance Map

- The general idea:
 - Select a crusher where you think optimization will be beneficial
 - Make a plan for what you would like to test
 - CSS, Speed, Curtain Position...
 - Run a sampling campaign
 - Particle size distribution, shape, capacity
 - Do the analysis
 - Convert test results into values of performance
 - Find the sweet spot

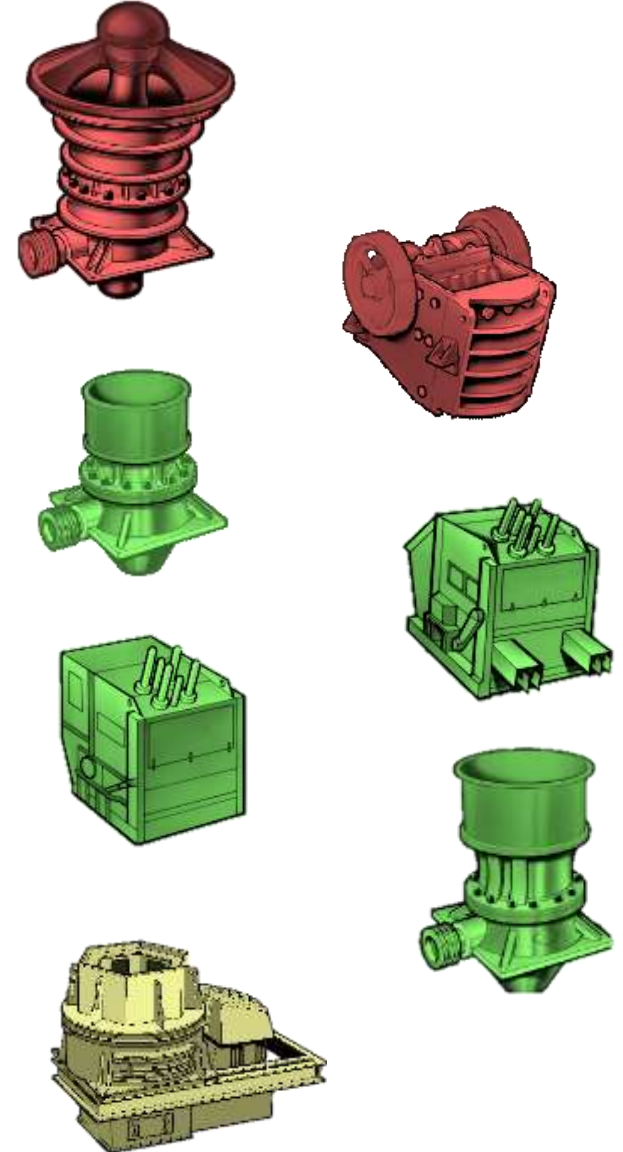

Crusher Performance Map

The Crusher Performance Map can assist your operator with maintaining efficient production

Crusher Performance Map

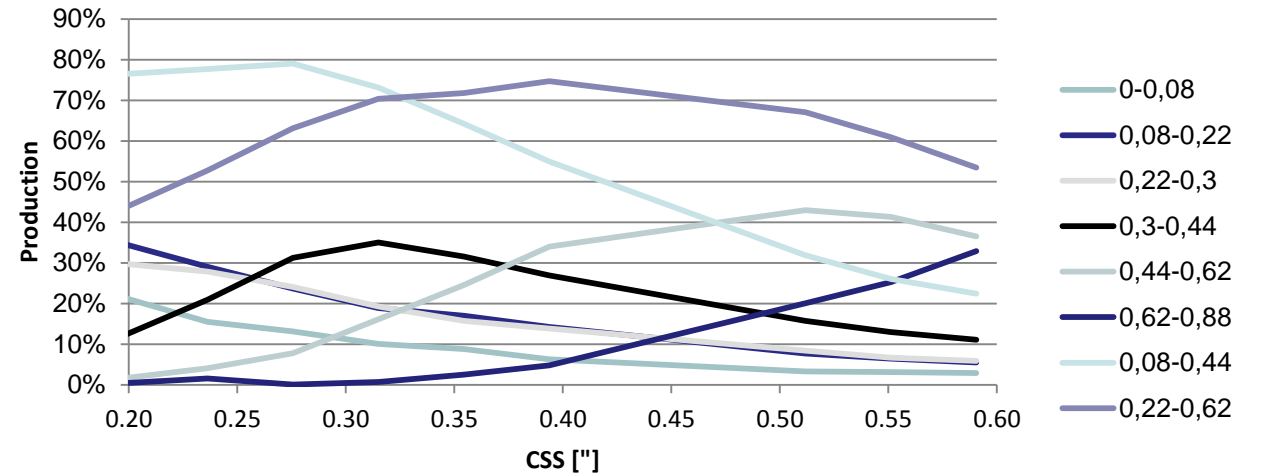

Crusher Performance Map

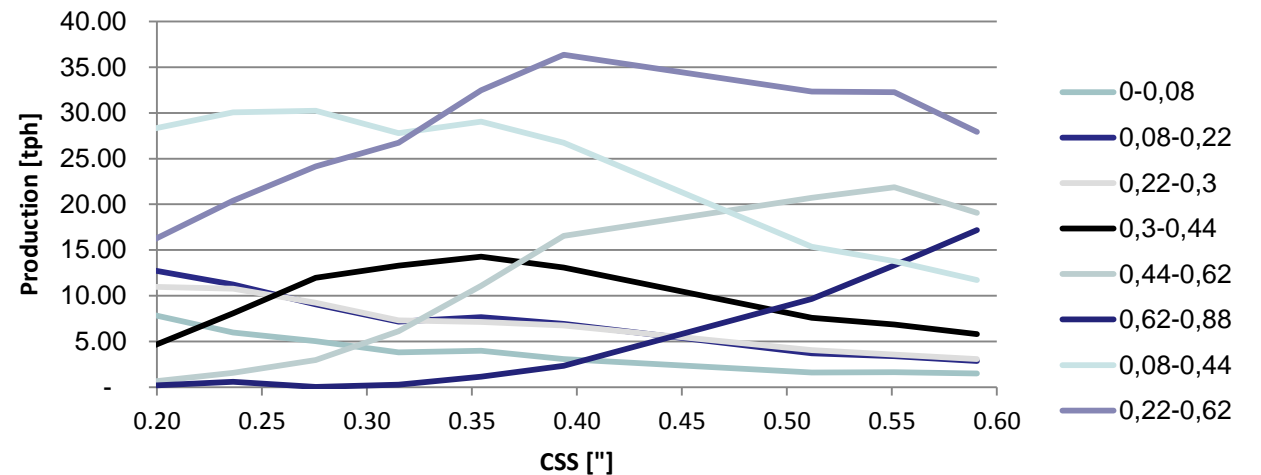

MinBaS II

Optimized blasting

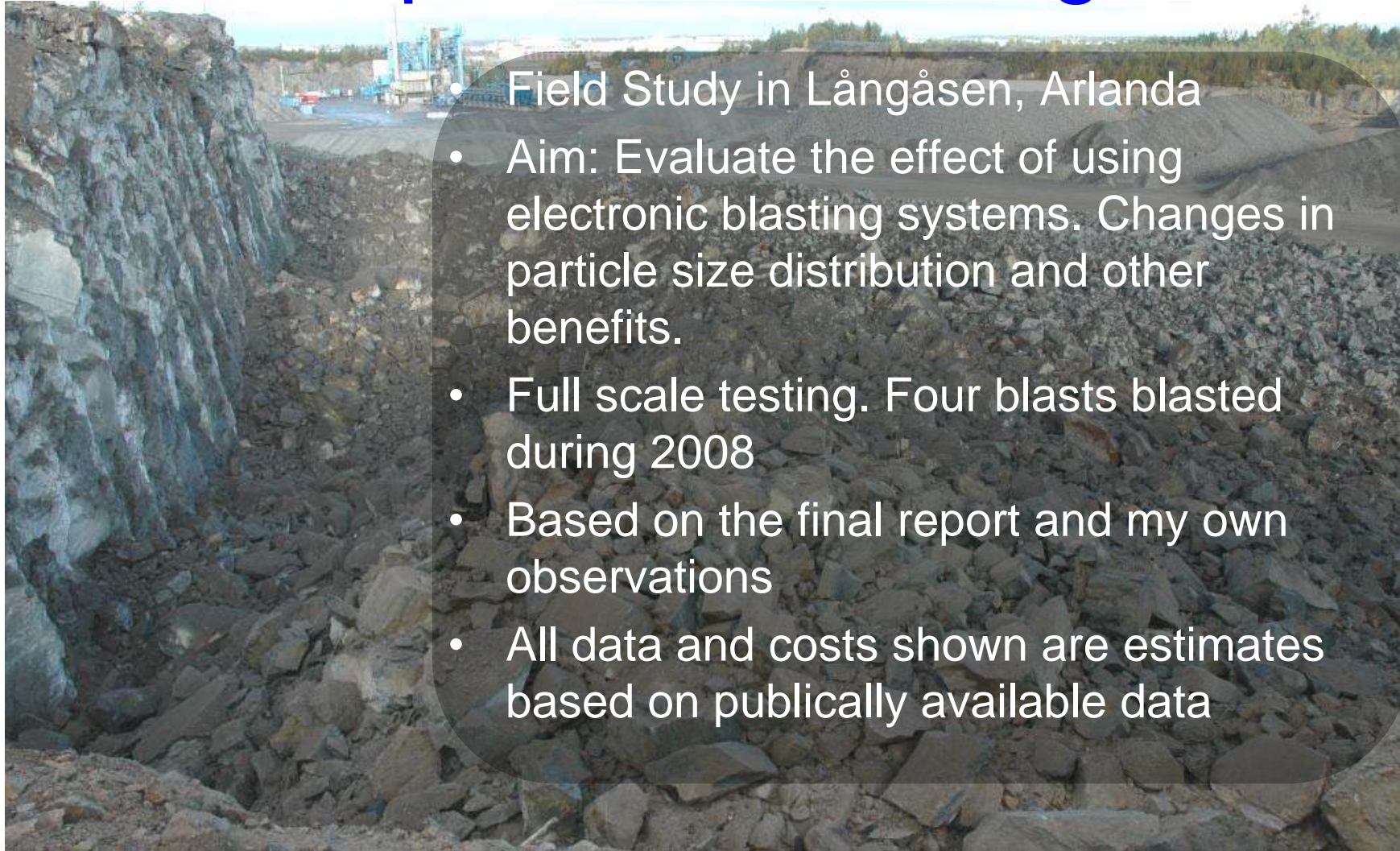

- Field Study in Långåsen, Arlanda
- Aim: Evaluate the effect of using electronic blasting systems. Changes in particle size distribution and other benefits.
- Full scale testing. Four blasts blasted during 2008
- Based on the final report and my own observations
- All data and costs shown are estimates based on publically available data

The Study

- Comparisons between the cost and earnings for different blasting strategies.
- Conclusions and recommendations

The Quarry

Långåsen, Arlanda



Blasted Material

Test plan

Blast 1	None Electric	None Electric
	1.35 lb/yd ³	1.85 lb/yd ³
Blast 2	None Electric	None Electric
	1.85 lb/yd ³	1.35 lb/yd ³
Blast 3	Electronic Blasting System	
	1.35 lb/yd ³ 10 ms between holes	
Blast 4	Electronic Blasting System	
	1.35 lb/yd ³ 5 ms between holes	

Blasting result

Measuring the Particle Size Distribution

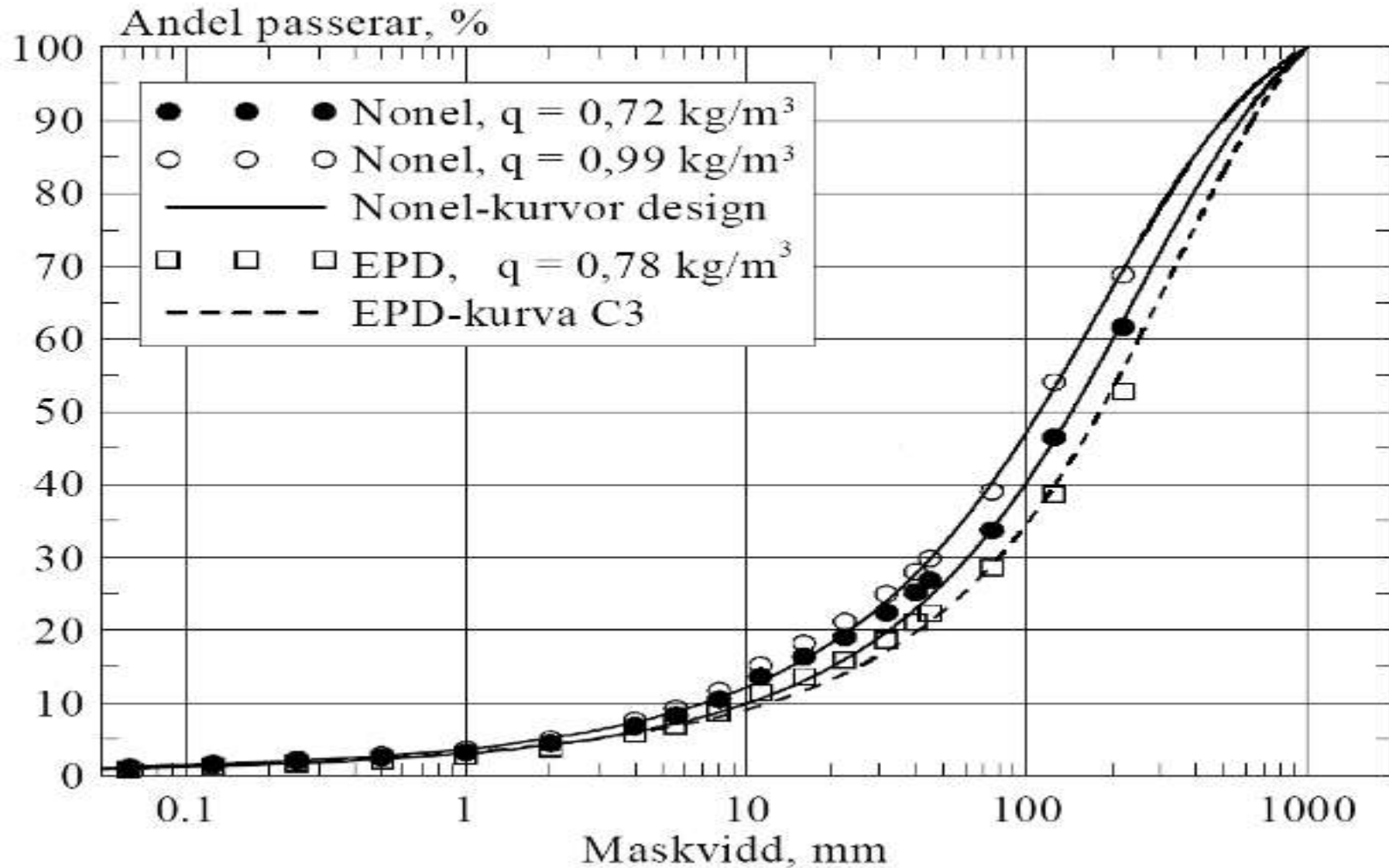

Blasting result Cost analysis

	Nonel norm. q [\$/ton*]	Nonel high q [\$/ton*]	EPD norm. q [\$/ton*]
Drilling and Blasting	0.90	1.23	0.97
Added cost for detonators	0,00	0,00	0.30
Bolder Management	0.30	0.15	0.22
Sum	1.20	1.38	1.49

*Estimates based on publicly available data

Loading and Hauling Conditions and Measurements

- Loading and Hauling to primary crusher
 - Wheel loader carries the material from the muck pile to the crusher
- Conducted studies
 - Measurement of wheel loaded loading times
 - Measurement of loaded material [tph]
 - Manual timing during several days



Loading and Hauling Cost analysis

	Nonel norm. q	Nonel high q	EPD norm. q
Contractor [\$/h*]	448	448	448
Loading Capacity [tph]	298	316	313
Cost [\$/ton]	1.50	1.42	1.43
Sum incl Drilling and Blasting [\$/ton]	1.20+1.50= =2.70	1.38+1.42= =2.80	1.49+1.43= =2.92

*Estimates based on publicly available data

Crushing and Screening Plant Setup and Conditions for the Study

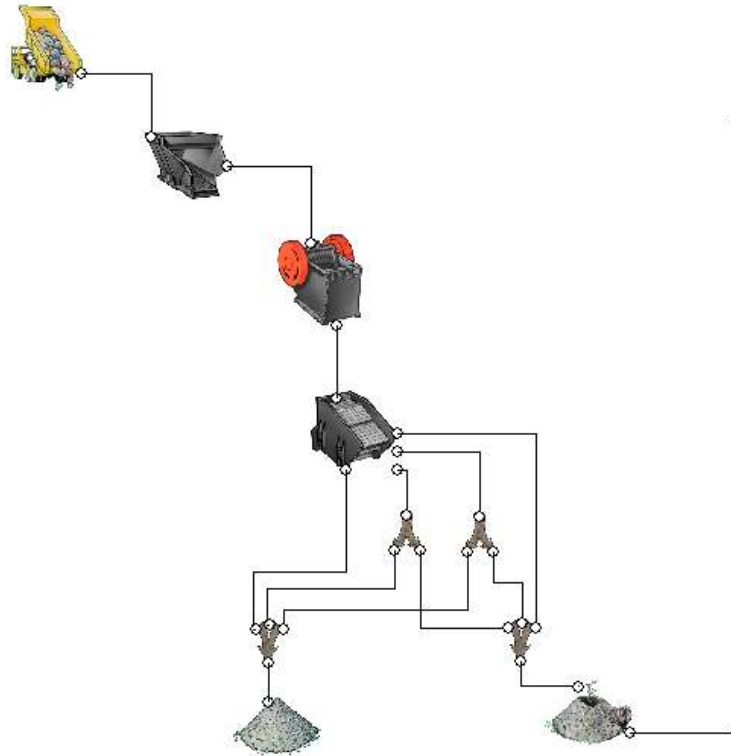

0-3.5"
(0-90 mm)

+3.5"
(+90 mm)



Crushing and Screening Performed Measurements

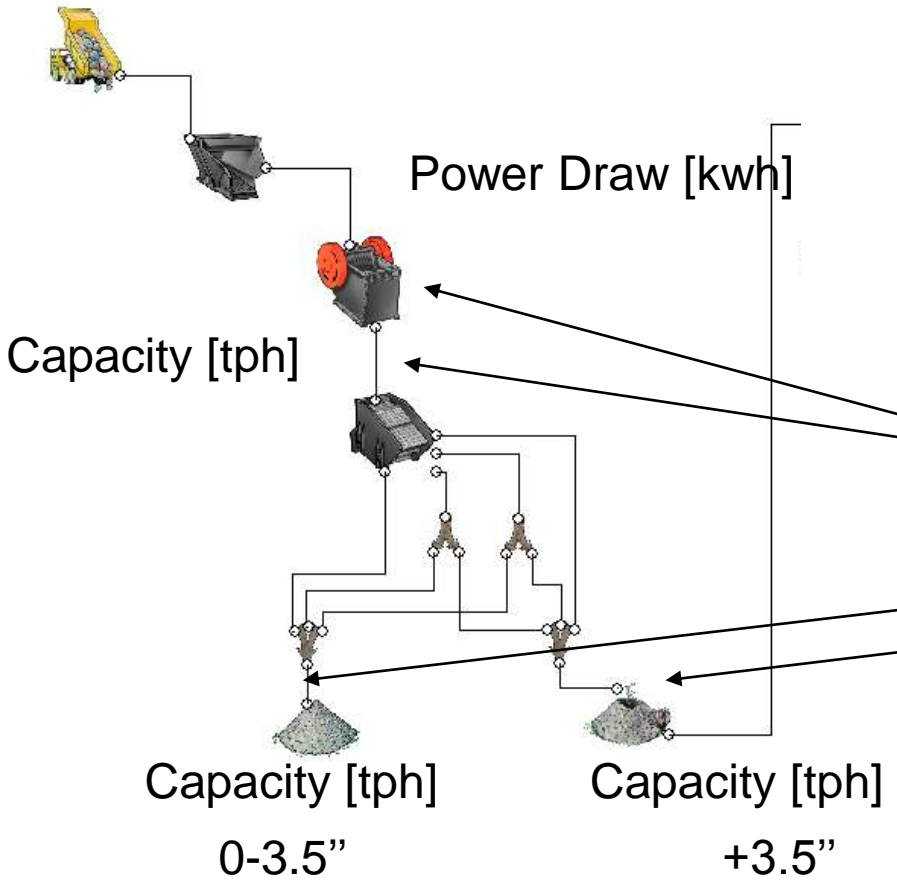

Crushing and Screening Cost analysis

	Nonel norm. q	Nonel high q	EPD norm. q
Power Draw (kWh/ton)	0.3	0.25	0.35
Energy Cost (0.30 \$/kWh)*	0.09	0.07	0.10
Fixed Cost [\$ /h]	746	746	746
[\$ /ton]	2.41	2.29	2.28
Cost [\$ /ton]	2.50	2.36	2.38
Sum incl D&B och L&H [\$ /ton]	1.20+1.50+2.50= = 5.20	1.38+1.42+2.36= = 5.16	1.49+1.43+2.38= = 5.30

*Estimates based on publicly available data

Production Total cost \$/h

	Nonel norm. q	Nonel high q	EPD norm. q
Production rate [tph]	298	316	313
Cost [\$ /h]	1600	1676	1723

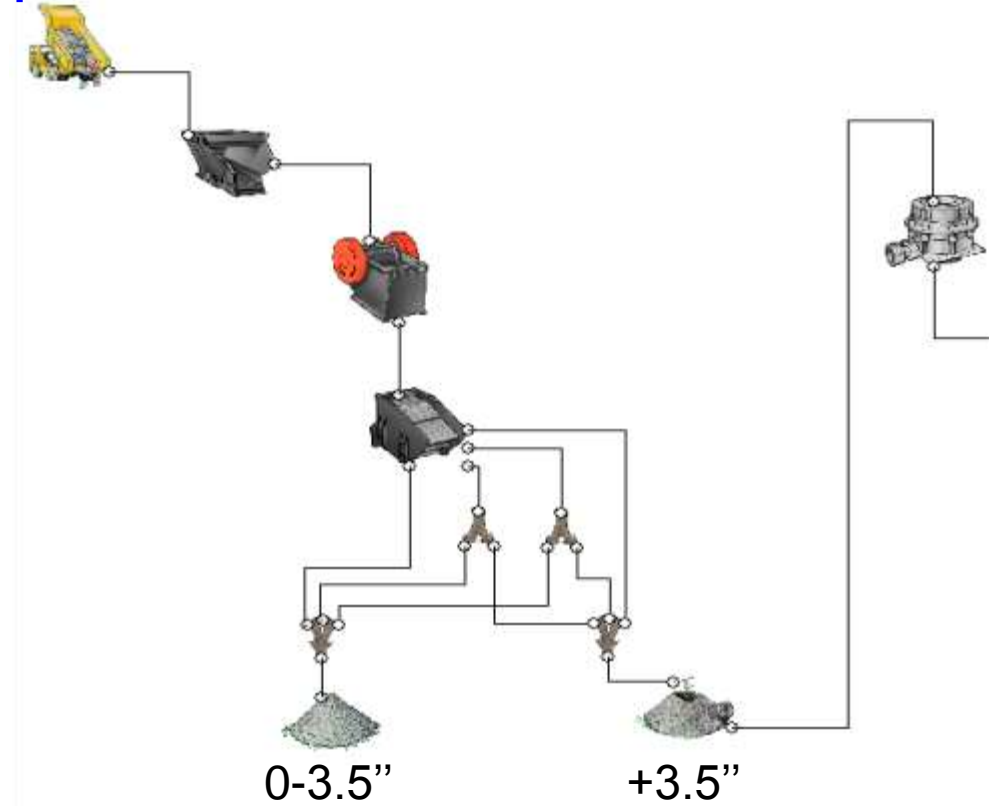

Distribution between 0-3.5" and +3.5" is partly controlled by the blasting result

Procuton Product Price

Fraction [mm]	Price [\$/ton]	Crushing stage	Ave. Price [\$/ton]
0-90	11.94	1 (Prim.)	11.94
0-4	19.25	3-4	21.19
4-8	20.75		
8-11	23.73		
11-16	22.53		
16-32	20.15		

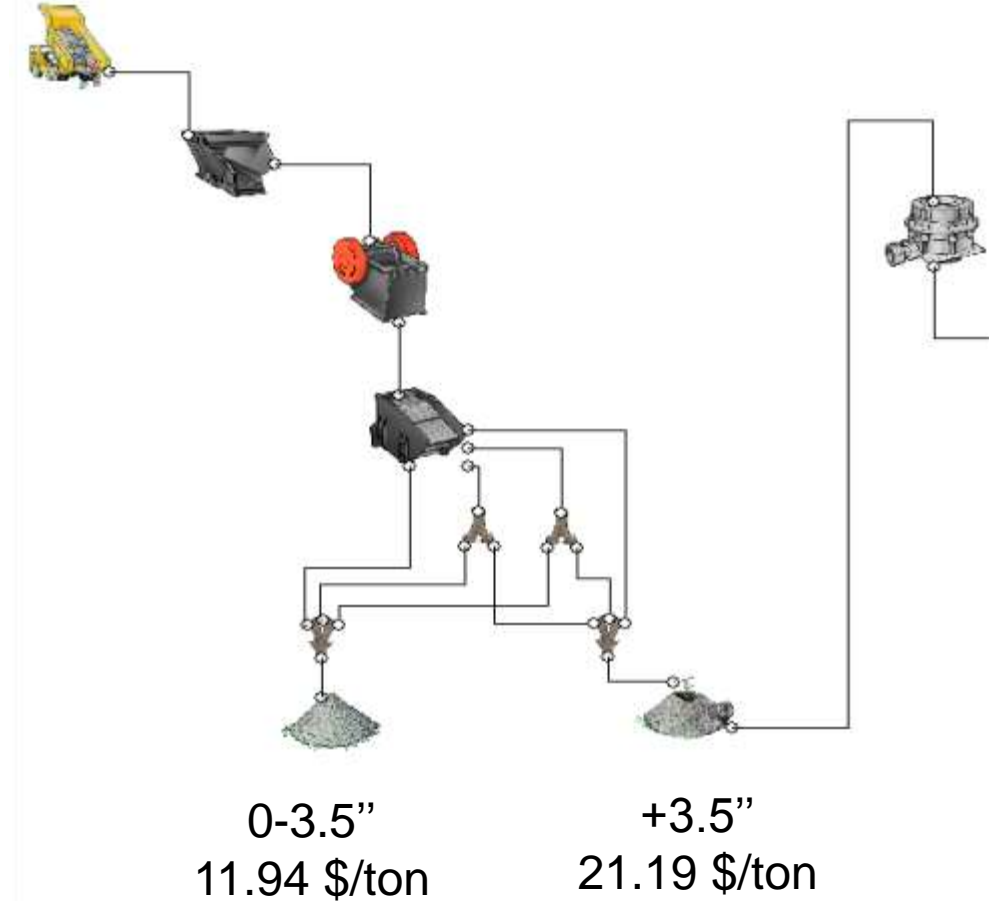

*Estimates based on publicly available data

Production Revenue sek/h

	Nonel normalt q	Nonel high q	EPD normalt q
Production [tph]	298	316	313
Production 0-3.5" [tph]	186	206	189
Price 0-3.5" \$/ton*	11.94	11.94	11.94
Production +3.5" [tph]	112	110	124
Ave. Price +3.5" \$/ton*	21.19	21.19	21.19
Revenue \$/h	4595	4791	4885



*Estimates based on publicly available data

Production Cost and Revenue*

	Nonel norm. q	Nonel high q	EPD norm. q
Production rate [tph]	298	316	313
Cost [\$ /h]	1343	1412	1425



Distribution between 0-3.5" and +3.5" is partly controlled by the blasting result

*Based on publicly available data

Conclusions

- From the tested blasting alternative Electronic Blasting System is the most beneficial.
- Extensive investigations and analysis are necessary in order to determine the optimal solution. Many areas are effected by the blasting result.
 - Drilling and Blasting
 - Bolder Management
 - Loading and Hauling
 - Crushing and Screening
- Only studying the costs is not sufficient in order to optimize the process. Most expensive solution did also generate the most profit.

Conclusions – Guidance for previous processes

- Feed to the primary crusher matters more than just boulders
- The effect of different feed gradations (blast results) are difficult to detect without measuring actively.
- Communicate effects upwards in the process

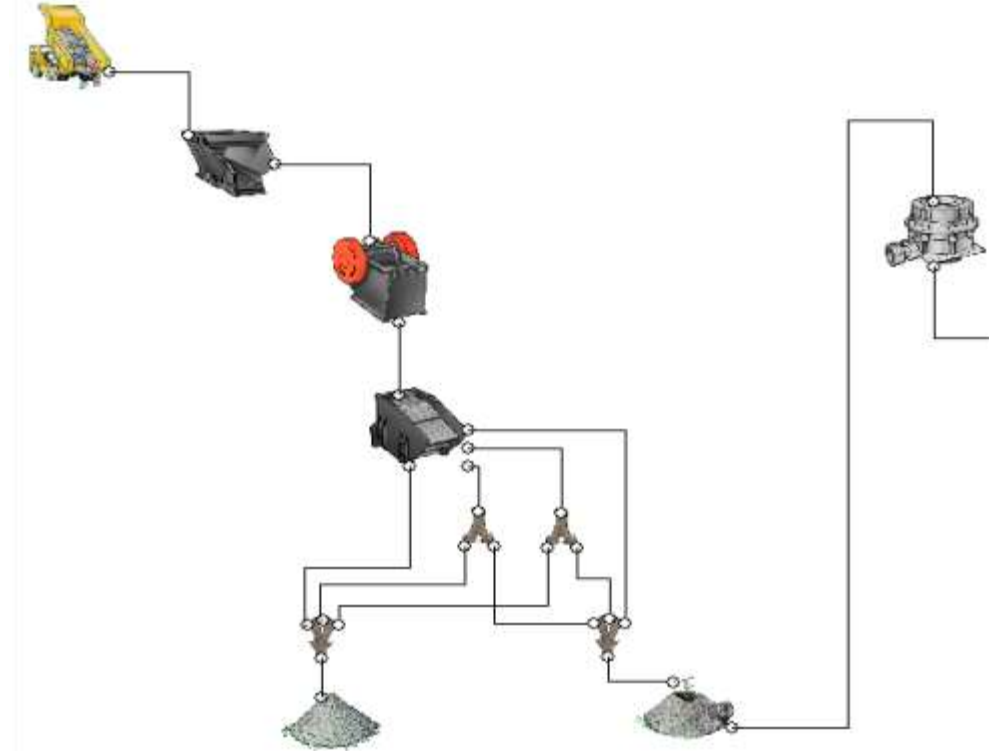

What about Optimizing the Crushing and Screening Process?

- Optimizing a single crusher can be done manually as seen earlier
- Optimizing several crushers?
 - Combination of equipment setting
 - Production situation, what products are demanded and what are not?

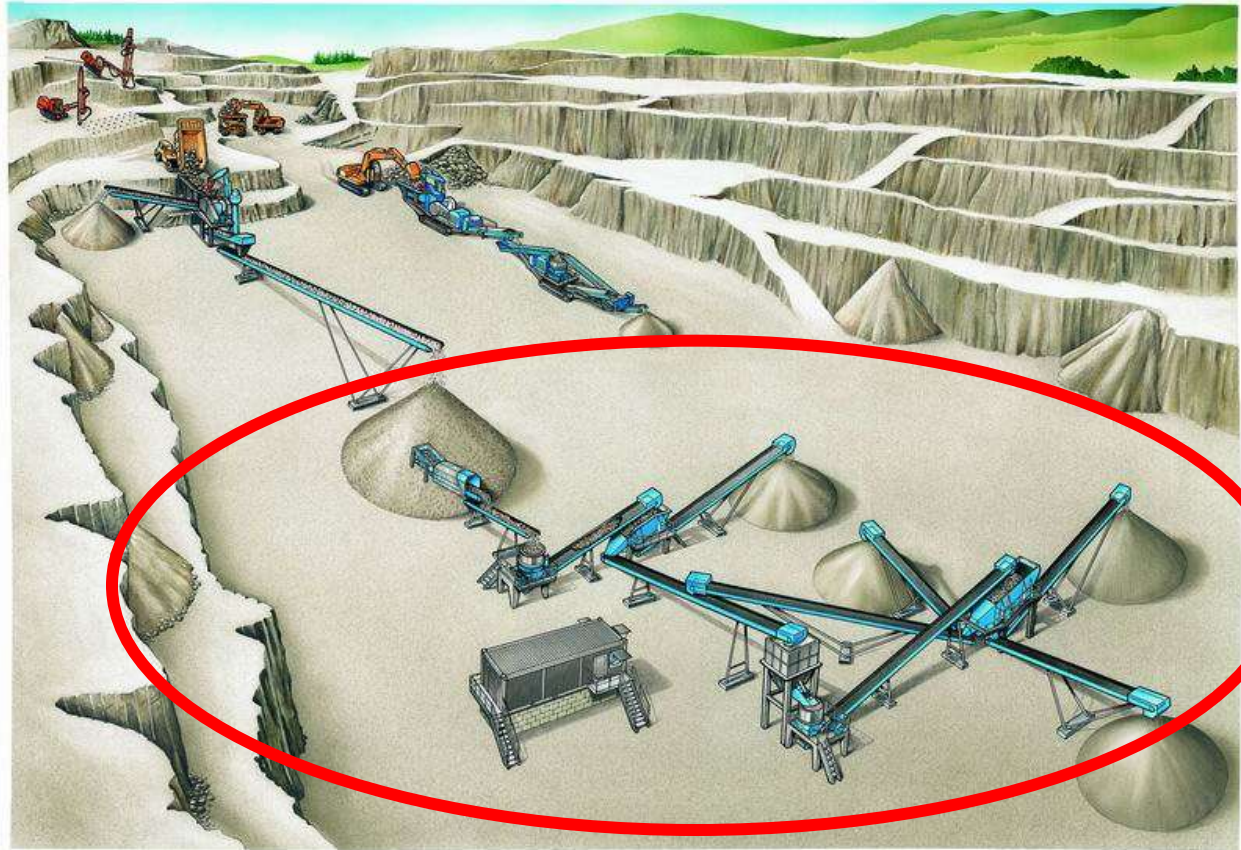

Modelling

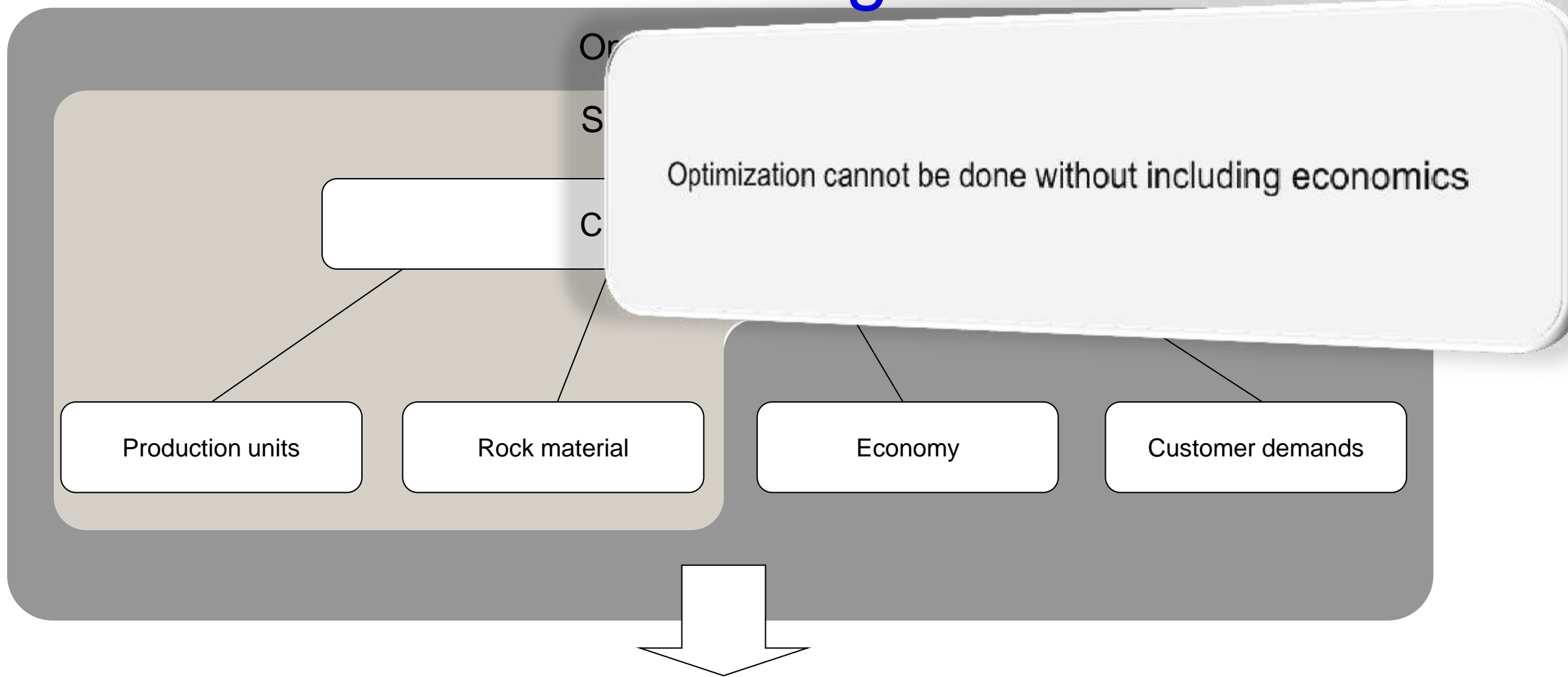

Crushing plant optimization using TCO

Calculation approach

- Included in cost the calculation
 - Raw material
 - Depreciation
 - Interest
 - Energy cost
 - Wear parts replacement
 - Service cost
 - By-product production
 - Personnel
- Income calculation
 - Sellable products
 - Product demand
- Other factors included that effects the gross profit
 - Availability
 - Utilization

Crushing plant optimization using TCO

Plant Challenges

What is the best trade-off between capacity and reduction?

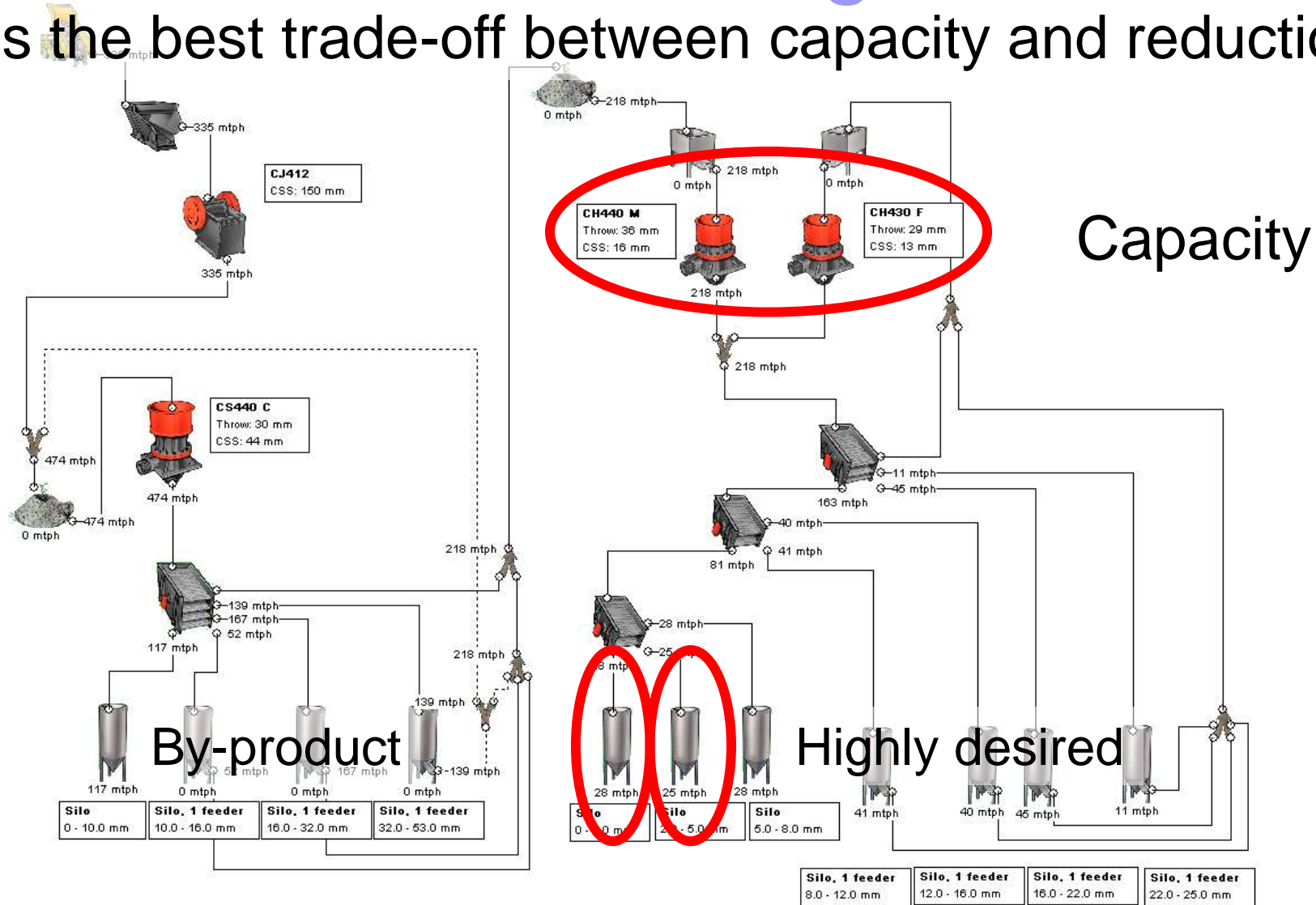

Crushing plant optimization using TCO

Test plant

In normal production following CSS are utilized:

- Secondary crusher – CSS 44 mm 1.73"
- Tertiary crusher – CSS 16 mm 0.63"
- Quaternary crusher – CSS 13 mm 0.51"

Products:

- 0-2 mm
- 2-5 mm
- 5-8 mm
- 8-11 mm
- 11-16 mm
- 16-22 mm

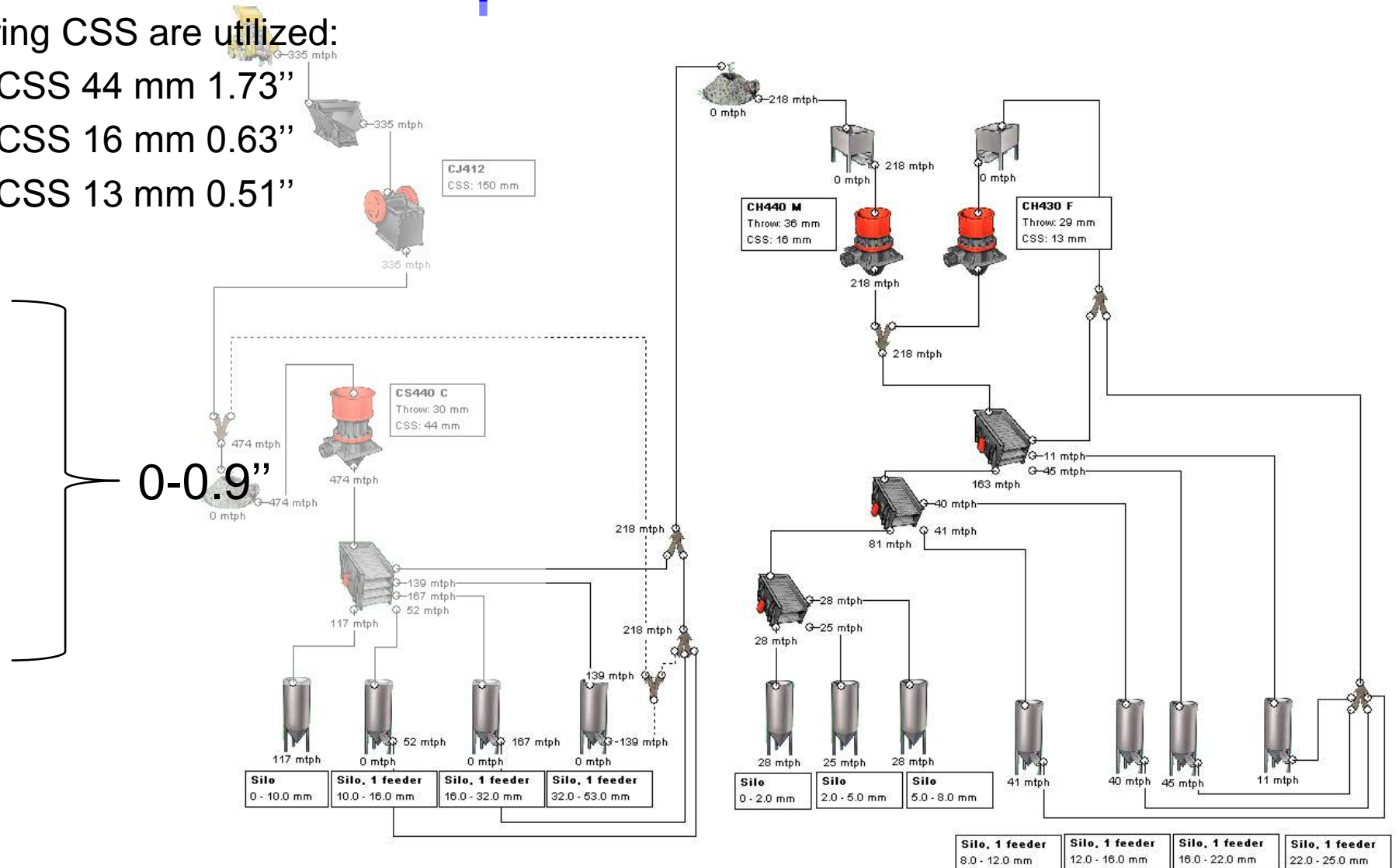

Crushing plant optimization using TCO

Test plan

Objectives for the first test session:

- Measure particle size distribution to calibrate the simulation model
- CSS at original settings

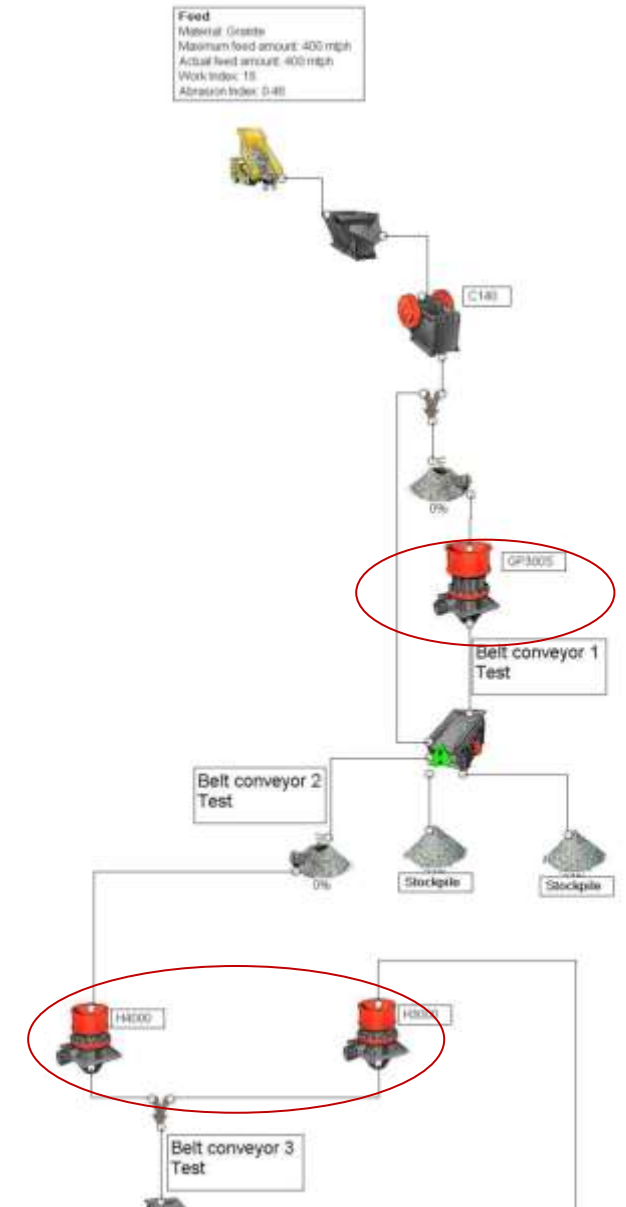

Crushing plant optimization using TCO

Model Calibration

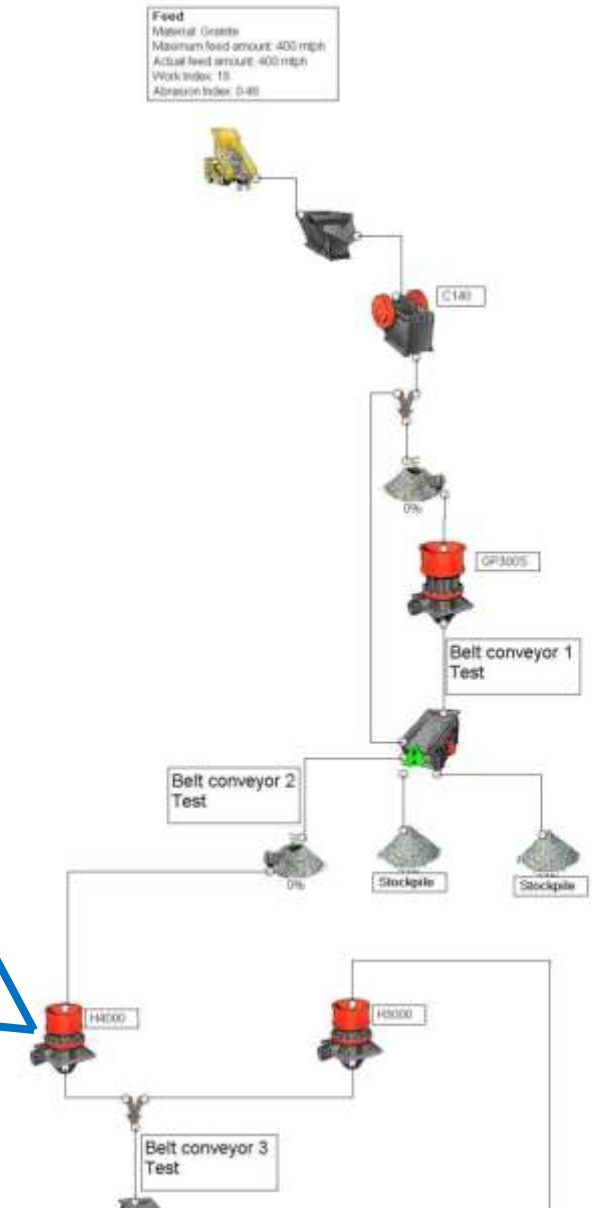
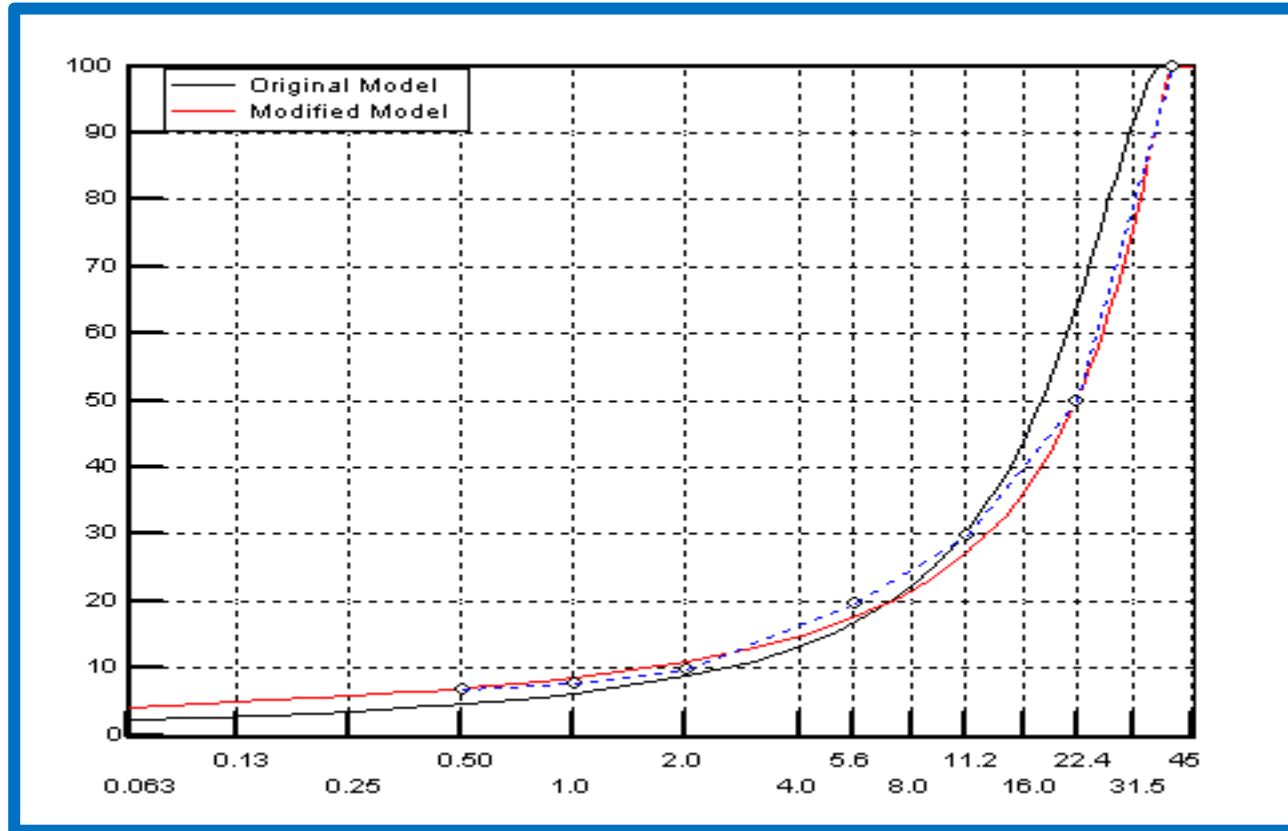

Crushing plant optimization using TCO

Running the TCO optimization module

The computer tool automatically finds the best solution using an optimization algorithm

The solution that yields the best profit:

- Secondary crusher – CSS 50 mm (44), 1.96'' (1.73'')
- Tertiary crusher – CSS 20 mm (16) 0.78'' (0.63'')
- Quaternary crusher – CSS 14 mm (13) 0.55'' (0.51'')

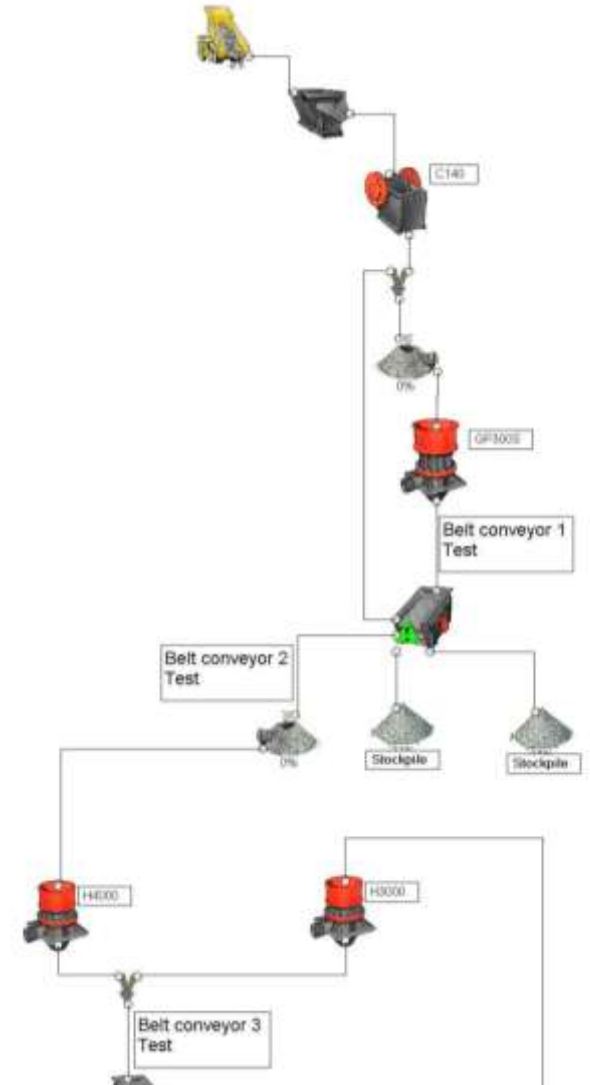

Crushing plant optimization using TCO Results

Result: +11 % in Calculated Gross Profit

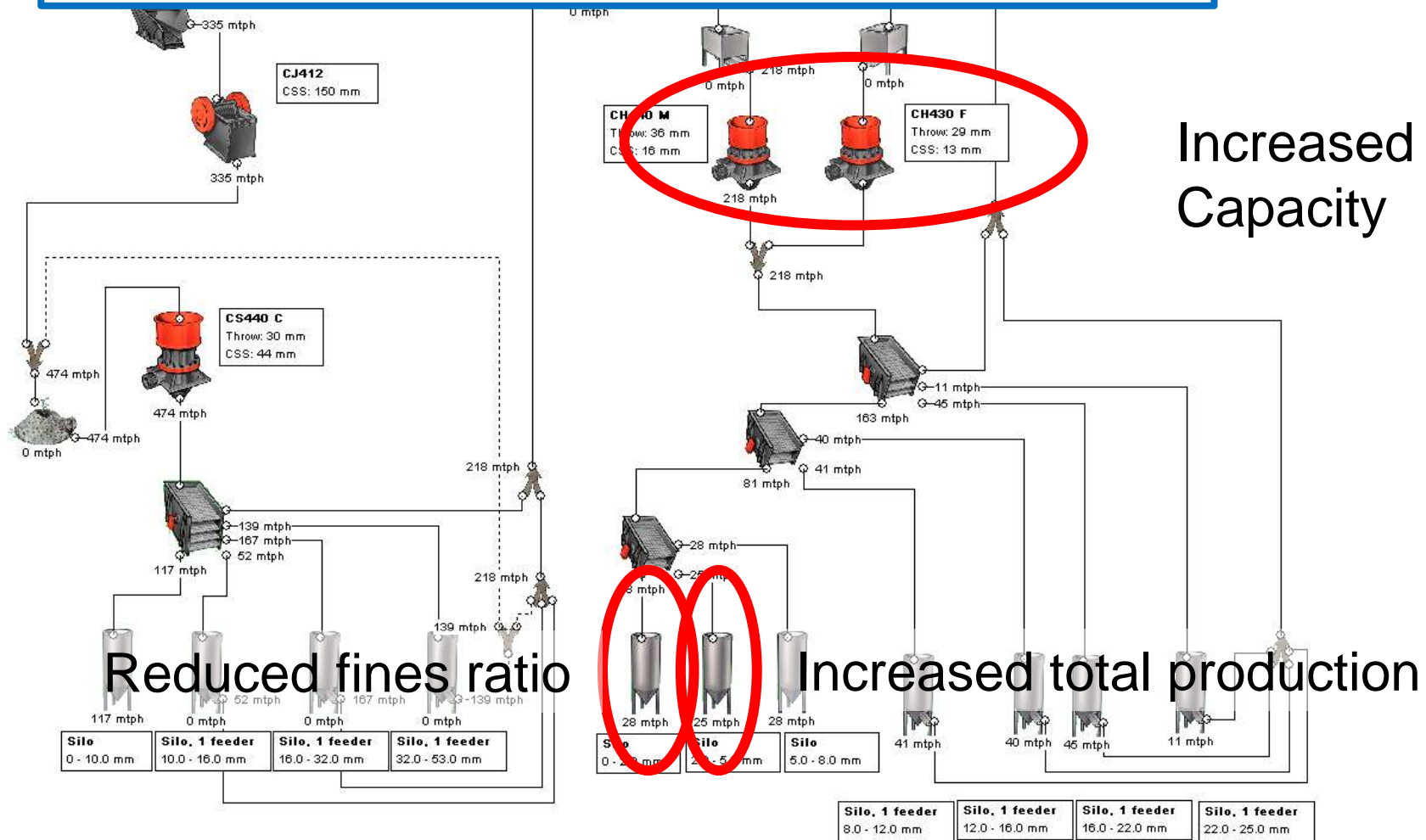

Crushing plant optimization using TCO

How can it be done?

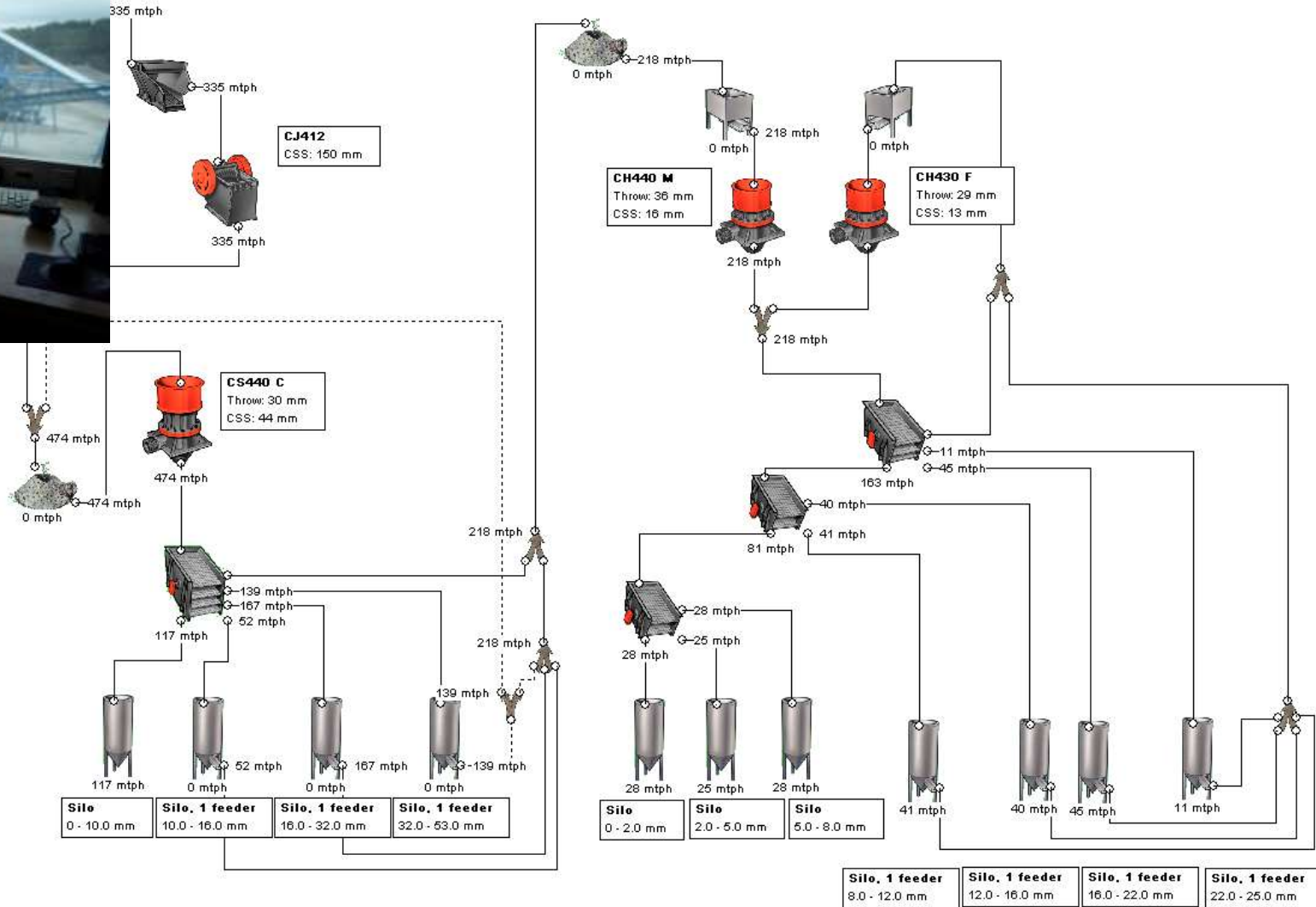

Crushing plant optimization using TCO

Conclusion

- Optimization must be a combination of technical and economic analysis
- Computer optimization can improve productivity
- Model calibration increases accuracy
- Minimizing cost does not necessarily maximize profit
- Combined performance of different machines should be considered. Solves the trade-off between capacity and reduction

www.quarryacademy.com



Improving Processes. Instilling Expertise.