

## Laboratory Flotation Testing – An Essential Tool for Ore Characterisation

Kym Runge



Manager – Flotation Process Technology, Metso Minerals (Australia) Limited, Unit 1, 8 - 10 Chapman Place, Eagle Farm Qld 4009. Email: kym.runge@metso.com

Dr Kym Runge is a mineral processing engineer specialising in flotation circuit analysis using modelling and measurement techniques. She currently works for Metso Minerals as a flotation specialist both consulting to industry and managing the development of Metso's flotation related product line. Her expertise in flotation was developed during a ten year period at the Julius Kruttschnitt Mineral Research Centre. During this time she initially studied for a PhD in flotation modelling and later worked full time as a researcher and consultant. She was instrumental in the development of JKSimFloat, which is used extensively in the industry for flotation circuit modelling and analysis. She also has three years industrial experience from when she worked at Pasminco's Broken Hill flotation concentrator.

Abstract

Introduction

Batch Laboratory Testing Procedures

Techniques Available for Interpreting Batch Laboratory Flotation Test Results

Areas of Application

Advantages and Limitations of Using Batch Flotation Testing for Circuit Diagnosis

Concluding Remarks

References

Appendix – Worked Examples

### ABSTRACT

The properties of the ore have a significant impact on the ultimate grade and recovery achievable in a flotation circuit. To maximise recovery, the proportion of particles containing the valuable mineral which are floatable should be maximised. To maximise the grade, the flotation rate of the valuable mineral should be significantly higher than the flotation rates of the gangue minerals in the ore. This is often referred to as 'maximising the selectivity'.

Laboratory batch flotation, in which a 1 - 2 kg sample of ore is floated using a standard set of operating conditions, is the standard technique used to assess ore floatability. Traditionally these tests have been performed extensively to determine the ultimate flotation design, screen potential reagents, determine optimum feed grind size and predict the change in performance of different ore types. These tests have usually been performed using the feed ore sample to the process but they are increasingly being used to characterise the floatability of internal flotation circuit streams and 'map' how the floatability is changing around a flotation circuit and across different processes.

Key ore floatability parameters (flotation rate constants and proportion of mineral in different floatability classes) can also be derived from the laboratory test flotation response. The values of these ore floatability

parameters can be evaluated and compared to rank different ore types or reagent suites. These parameters are also suitable for predicting, through mathematical modelling, the grade-recovery relationship achievable in a multistage flotation circuit.

There are various graphical and modelling techniques that have been developed to interpret laboratory batch flotation test results. In this chapter, the recommended procedure for performing these laboratory flotation tests and the various graphical and modelling analysis methods used to interpret these test results will be outlined.

### INTRODUCTION

To achieve separation in the flotation process, those particles containing the valuable mineral need to float and they need to float more quickly than those containing predominantly the gangue minerals. The particle size, degree of liberation of the minerals and the hydrophobicity of the mineral surface will in large dictate a mineral's recovery rate. Grinding and chemical addition are weapons in the metallurgist's armoury used to modify particle properties for a particular ore type in an attempt to achieve maximum separation.

A vast array of techniques can be used to predict the optimum grind size and chemical suite to use for a particular ore. Ultimately, there is always a need for small-scale testing to validate the results of these analyses or to explore, screen or prioritise different options. This is where laboratory batch flotation testing and the various techniques that can be used to analyse these batch test results come in useful. They are relatively easy and inexpensive to perform in comparison to detailed liberation or chemical speciation analyses and they go some way to replicating the process conditions that will be present in the full-scale processing plant.

The aim of this chapter is to outline how these ore characterisation tests should be performed and demonstrate the various graphical and modelling techniques that can be used to interpret the results produced from these tests.

**BATCH LABORATORY TESTING PROCEDURES**

**The standard procedure**

There are various designs of laboratory-scale flotation cells which can be used to perform the laboratory batch flotation tests. My preference is to use a bottom driven laboratory cell allowing impeller speed and air rate adjustment, an example of which is shown in Figure 1. This type of cell, used with a fixed depth scraper to regularly remove the entire froth phase during concentrate collection, can produce reproducible test results even between different operators.

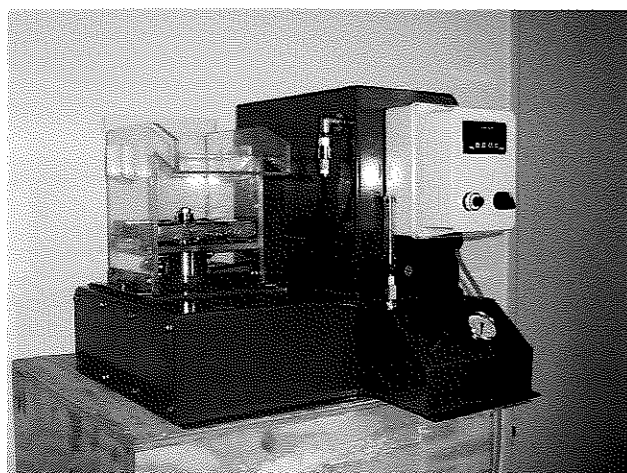

FIG 1 - A bottom driven laboratory flotation cell supplied by Runge Engineering.

A typical test involves washing an ore pulp sample into the laboratory cell. Make-up water is added to achieve the desired volume. The impeller is started and set to the desired speed. Collector and depressant (if required) are then added and an appropriate conditioning time is allowed to elapse. At the instant the air flowmeter is set to the appropriate air rate, the timing of the test commences. The concentrate produced from the cell flows and/or is scraped into trays and at designated time intervals the trays are removed and replaced. Water is continually added to the cell to maintain the desired froth level. The test continues until the froth is barren and no more particles are reporting to the froth in significant quantities. It is recommended that one more concentrate be collected after this point to ensure the end point of the test can be established.

All concentrate samples and the final tailing sample are weighed wet and dry and assayed for the elements of interest. These results are used to calculate the rate of mineral recovery as

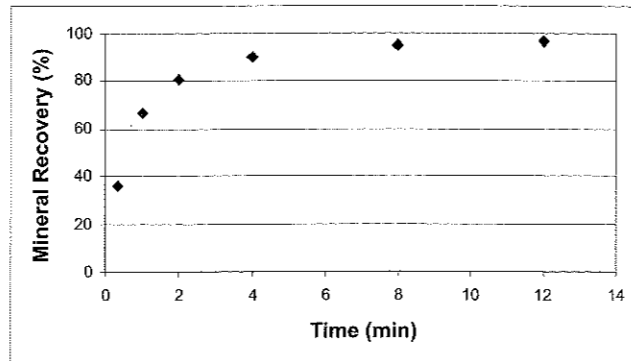

FIG 2 - Typical mineral versus recovery time curve obtained from a laboratory batch test.

a function of time, usually on a cumulative basis. A typical cumulative mineral recovery curve is depicted on Figure 2.

As an aside, the water in the concentrate versus the water in the flotation cell will be used to estimate recovery by the entrainment mechanism. Thus known quantities (or no) water should be used to wash concentrate into the tray.

Samples to be tested can be collected directly from an operating flotation circuit, referred to as 'hot samples', or prepared in the laboratory – grinding to produce the appropriate particle size or adding reagent to achieve the required pulp chemistry. The time between sample collection and flotation should be minimised to prevent ageing or oxidation of particle surfaces prior to testing.

The weight or size of sample added to the laboratory flotation test should be chosen to achieve the required pulp density. Pulp density is a variable which often affects batch flotation test results. As it is easier to add water (rather than remove it), it is recommended that all samples be floated at a low per cent solids (ie less than ten per cent solids). The use of a low per cent solid also minimises the risk of bubble saturation or overloading. In tests where there is a high proportion of floatable solids performed using a low air rate and at a high pulp density, bubble surfaces can become saturated, resulting in low recovery rates. This condition should be avoided as the result is no longer a function of only the ore but the air rate used in the test.

The water used to dilute the samples and added during a test to maintain froth depth should be as similar to that used (or to be used) in the plant as possible. Water properties (ie ph, Eh, temperature, dissolved oxygen and dissolved molecules) will affect the composition of reagent and deposition products on particle surfaces, which ultimately affects ore floatability. Frother (as long as it has no collecting properties) should also be added to all make-up water in sufficient quantities to maintain a constant bubble size in the pulp and minimise bubble breakage within the froth phase. For most frothers, a concentration of 20 ppm within the make-up water will be sufficient for this purpose. Distinct additions of frother in the middle of a test should be avoided as they can result in a spike in flotation recovery.

It is important that all tests are performed using the same air rate, impeller speed, froth depth and froth scraping rate so that any change in a batch test result is a consequence of a change in the ore characteristics rather than to any change in the environment in which it is floated. The air rate chosen should be high to prevent bubble saturation and maintain a fluid non-collapsing froth. Air rates of 10 - 18 L/min are usually appropriate for tests performed using a 5 L cell. Impeller speed should be sufficient to keep all solids in suspension but not that high that molecules loosely deposited on surfaces are stripped off. An impeller speed within 750 to 1000 rev/min is recommended.

Ideally the froth should be removed the instant it is formed so that differences in results can be attributed to changes in pulp flotation kinetics rather than to any change in the flotation froth characteristics. As a practical compromise, it is recommended that two to three centimetres of froth be maintained throughout the test and a scraper of sufficient depth be used to remove all but 0.5 cm of this froth at regular time intervals. Make-up water should be added regularly to maintain a constant froth depth as solids and water report to concentrate. A fast froth scraping rate is desirable but one stroke every ten seconds is usually a speed that allows the execution of other tasks (addition of water and changing of trays).

The time intervals over which each concentrate is collected should be chosen such that the shape of the mineral recovery time curves can be well established for the particular operating conditions chosen to do the tests. A test of a slow floating platinum ore, for instance, may require 45 minutes to an hour to reach completion and thus the first concentrate can be collected after two minutes of flotation. A faster floating copper porphyry flotation test, however, may finish in five minutes and a first concentrate may need to be collected after 20 seconds.

Depending on one's circumstances, some deviation may be required from the recommended test conditions (eg use of high per cent solids to obtain sufficient concentrate samples for assay, samples left to sit for long periods). Tests should be performed to establish whether any adverse effect arises from the proposed change.

**Reflotation and lock cycle tests**

The grade versus recovery relationship derived from a standard batch laboratory flotation test will not be that achievable in a multiple stage flotation circuit. Multiple stage flotation results in a more efficient separation between particles of different floatability. Figure 3 demonstrates this point by showing the flotation separation curves for a batch flotation test (calculated using flotation modelling techniques) performed over different time periods and for tests in which the concentrate has been refloatated. The flotation separation curve is a plot of recovery versus the flotation rate of a particle in a particular flotation process. If a flotation process was a perfect separator, the separation curve would be a vertical line – complete recovery of particles to the right of the line and no recovery of particles to the left. The probabilistic nature of the flotation process, however, results in non-ideal separation.

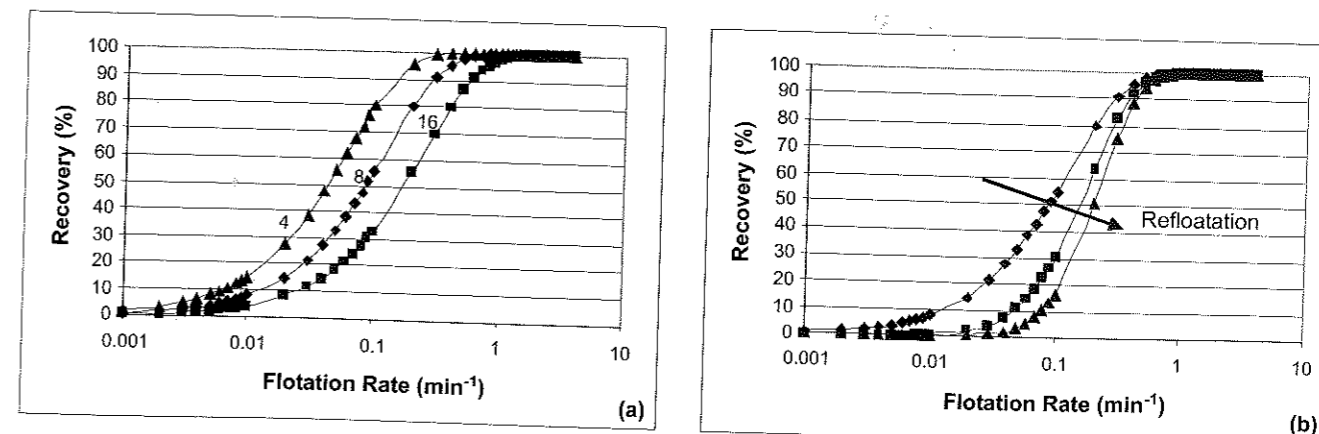

FIG 3 - Recovery of particles with different flotation rates (a) after four, eight and 16 minutes of flotation and (b) after one, two and three refloatation stages of eight minutes in duration.

It is clear from these graphs that a change in flotation time (Figure 3a) simply increases or decreases flotation recovery but does not result in changes in separation efficiency. A steepening of the separation curve, however, results from refloating the concentrate (Figure 3b). This occurs because of the increase in the fast to slow ratio of particles in the feed to subsequent stages. The net result of this improvement in separation efficiency is an improvement in the concentrate grade or purity achievable at a particular mineral recovery.

Lock cycle batch flotation experiments provide a better insight into the expected grade and recovery achievable from multistage processing of an ore. These tests are performed such that they replicate, on small scale, the full-scale flow sheet. To incorporate the effect of recycle streams, they are often performed multiple times with the recycled streams from a previous test added at the appropriate place in the subsequent test. Tests are performed until the mass flow in all samples converges to a constant value. Figure 4 shows a schematic of a lock cycle test performed to replicate a rougher/cleaner flotation circuit in which the cleaner tail is recirculated back to the feed.

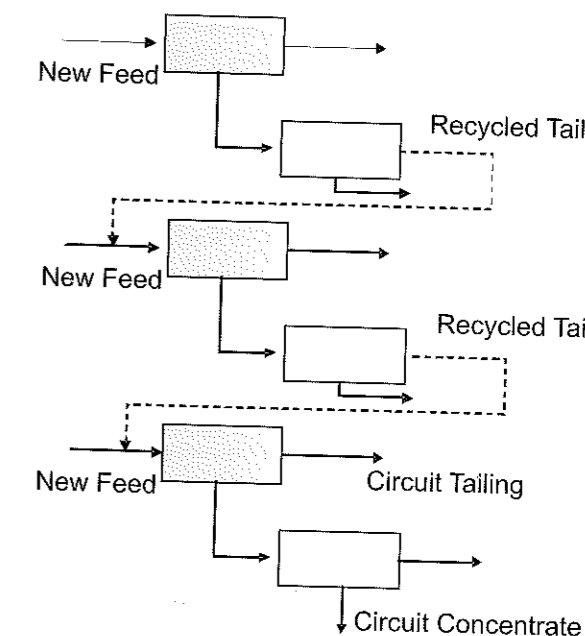

FIG 4 - Lock cycle test schematic.

The disadvantage of these types of tests is that they are time-consuming to perform and they result in a single grade and recovery value rather than the relationship between the two values derived from the single stage test. To investigate an alternative flow sheet or a change in the residence time of a stage, another experiment needs to be performed.

A more time-effective option for estimating multistage circuit grade and recovery is to model the data from a single stage experiment (or a lock cycle test). This model can be used to mathematically predict circuit grade and recovery achievable from different circuits. The procedures to perform this type of analysis will be outlined later in the chapter.

### TECHNIQUES AVAILABLE FOR INTERPRETING BATCH LABORATORY FLOTATION TEST RESULTS

#### Mineral recovery, grade versus recovery and selectivity curves

Mineral recovery, grade/recovery and selectivity curves are all graphs that can be constructed from the information collected during a single batch flotation experiment. These curves are ideal for comparing the results of different tests.

The mineral recovery curve displays the cumulative mass of mineral (on a percentage basis) recovered at each time interval during a test. The slope of this curve is an indicator of the rate of flotation recovery and the recovery value at which the curve asymptotes is an indicator of the proportion of floatable mineral in the tested sample (Figure 5).

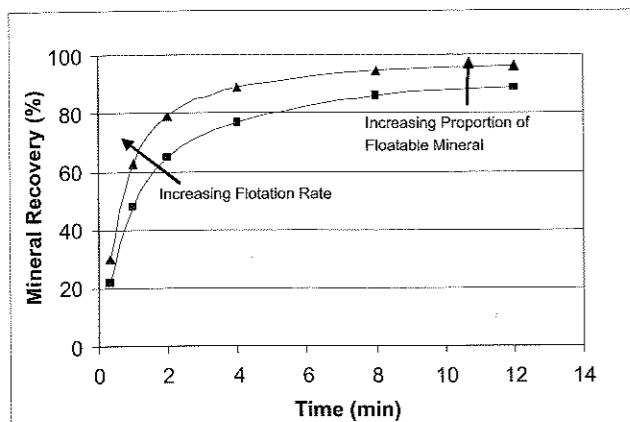

FIG 5 - Cumulative mineral recovery curve with the important features denoted.

It is desirable that the valuable mineral in a sample exhibit fast flotation kinetics (steep slope) and the proportion of non-floating mineral in the sample be minimised. The proportion of non-floating valuable mineral is an indicator of the amount of mineral that is either in particles too large or small for flotation, locked with non-floating particles or with a hydrophilic surface due to insufficient collector coverage or depressant coatings. Regardless of the reason, non-floating mineral is not recoverable in a flotation circuit and should be minimised if circuit recovery is to be maximised.

Flotation is a separation process and thus it's important that the valuable mineral is not only recoverable but that it's recoverable to a greater extent than the gangue mineral. Selectivity curves are ideal for this type of evaluation. On these curves, the recovery of the valuable mineral is plotted against the recovery of a mineral of interest (Figure 6).

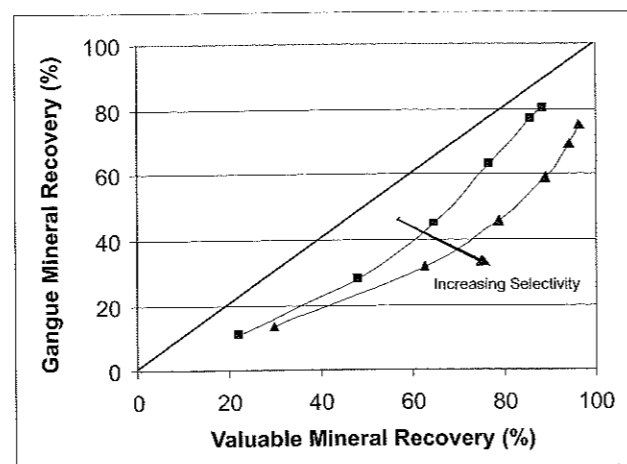

FIG 6 - Mineral selectivity curves with the important features denoted.

The 45 degree line on this plot represents the points at which no selectivity occurs – the recovery of valuable mineral is equal to the gangue mineral recovery and no separation is achievable. The further to the right of this line the selectivity curve lies, the better. Different selectivity curves should be created for each of the gangue minerals of interest as different minerals often exhibit different degrees of selectivity with the valuable mineral.

The overall measure of selectivity in the batch flotation test is the grade (or purity) of the concentrate produced. The cumulative concentrate grade versus cumulative recovery curves (Figure 7) produced from different tests can be compared to determine those conditions which result in the best selectivity with respect to all minerals.

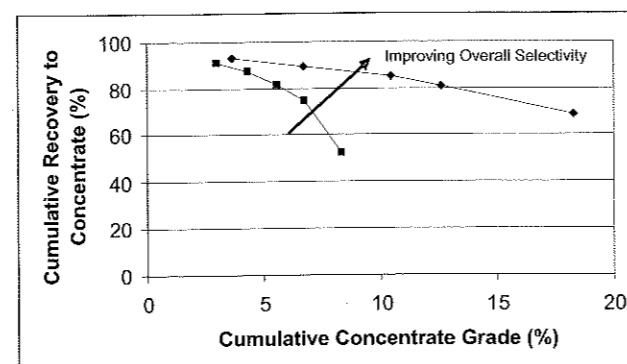

FIG 7 - Cumulative recovery versus cumulative concentrate grade produced during a batch flotation experiment.

These curves do not, however, give an estimate of the grade and recovery achievable in a multiple stage flotation circuit. Lock cycle tests or modelling are better suited to this task. These curves do give a good relative measure of selectivity. An improvement in selectivity in these tests should result in a better grade at a particular recovery at full scale.

#### Entrainment assessment techniques

Gangue can report to the concentrate either attached to bubbles (due to its own hydrophobicity or because of an association with a hydrophobic mineral) or entrained with the water phase. It is important to be able to differentiate between these two recovery mechanisms as ultimately this distinction may affect the strategy that is adopted to reduce gangue recovery. This section outlines techniques that can be used to estimate the degree of entrainment in a laboratory batch flotation test.

Entrainment is a consequence of particles suspended in the pulp phase following the water into the froth and ultimately into the concentrate. The mass of a mineral entrained into the concentrate is proportional to the water flow to concentrate and can be estimated using Equation 1 (Johnson, 2005). The classification function ( $C_{fi}$ ) is a factor to account for the degree of drainage with respect to the water flow and must be estimated to perform the calculation. It is known to fall between zero and one; zero representing the condition of total drainage where there is no entrained recovery of particles regardless of the water recovered, and one representing the condition where there is no drainage and the concentration of particles in the water in the concentrate (due to entrainment) is the same as in the pulp phase.  $C_{fi}$  is known to be strongly dependent on size with the coarser particles exhibiting a high degree of drainage ( $C_{fi} = 0$ ) and the fine particles usually following the water phase ( $C_{fi} = 1$ ).

$$F_i = C_{fi} \omega_{i,pulp} F_w \quad (1)$$

where:

$F_i$  is the flow of a component  $i$  into the concentrate due to entrainment

$C_{fi}$  is the classification function for component  $i$

$\omega_{i,pulp}$  is the mass to water ratio of component  $i$  in the pulp phase

$F_w$  is the flow of water to the concentrate

Thus to calculate the recovery by entrainment in a batch test, the water to solids ratio in the pulp, water flow to concentrate and an estimate of  $C_{fi}$  is required. The water flow to concentrate can be measured and the average water to solids ratio in each stage can be estimated based on knowledge of the cell volume and the particle mass balance. The challenge is to estimate the degree of drainage in the system.

If one of the minerals is known to be non-floating, an inversion of Equation 1 can be used to calculate a  $C_{fi}$  estimate for the other minerals in the ore. This, unfortunately, is not usually the case with even the non-floating minerals locked to some extent with the valuable and exhibiting floatability. Johnson (2005) published typical values of  $C_{fi}$  for siliceous non-sulfide gangue (Table 1). These values coupled with knowledge of the particle size distribution of a particular sample can enable a reasonable estimate of  $C_{fi}$  to be calculated.

TABLE 1  
Typical values of  $C_{fi}$  (after Johnson, 2005).

Size fractions ( $\mu\text{m}$ )				
-11	-16 +11	-23 +16	-33 +23	-44 +33
0.77	0.46	0.30	0.24	0.13

Alternatively,  $C_{fi}$  can be estimated using results from the batch test by recognising that towards the end of an experiment, the predominant particle recovery mechanism is entrainment. If one calculates the ratio of mineral to water in both the concentrate and pulp and plots this value for each stage of a batch experiment (Figure 8), it usually decreases, asymptoting at a particular value towards the end of the test. This value is an estimate of the  $C_{fi}$  value. The larger values at the beginning are because recovery is due to entrainment and flotation in these earlier stages.

Once a  $C_{fi}$  estimate has been obtained and the gangue entrainment flow has been calculated (Equation 1), a cumulative entrainment recovery curve can be constructed which can be

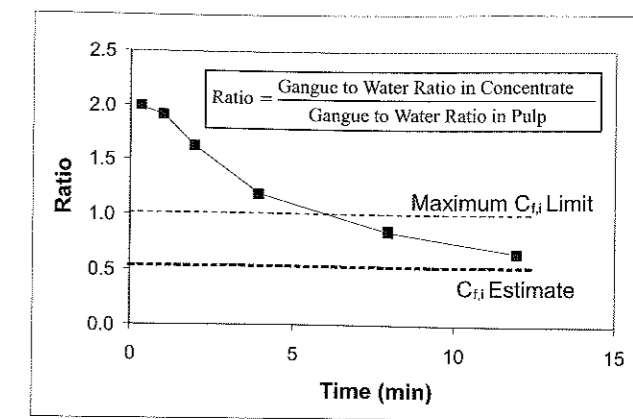

FIG 8 -  $C_{fi}$  calculated using Equation 1 versus time in a batch flotation test.

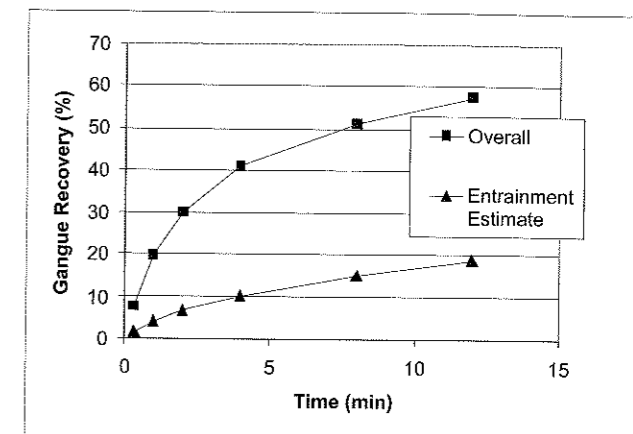

FIG 9 - Curves used to assess the predominant gangue recovery mechanism in a batch flotation test.

compared to the overall recovery curve for that mineral (Figure 9). The difference in these two curves is the proportion of the mineral recovered due to true flotation (attachment to bubbles).

#### Ore floatability mapping in a flotation circuit

Traditionally batch flotation tests have only been performed using samples representative of a flotation circuit feed. Much can be learnt, however, by floating the samples collected from different streams of an operating flotation circuit.

During flotation the faster floating particles will report to the concentrate streams, whereas the slower floating particles will report predominantly to the tailing streams. This results in different streams possessing very different ore floatability properties. As an example, Figure 10 shows the copper recovery achieved in batch flotation tests performed using different streams from Rio Tinto's Northparkes flotation circuit.

This information can then be assessed in terms of mineral recovery and selectivity. A traditional rule of thumb is to recirculate streams to a point of similar assay. A better philosophy is to recirculate streams to a point of similar floatability.

The final tailing is of special importance as it is discarded and any valuable mineral contained in this stream is a lost opportunity. High valuable mineral recovery rates coupled with good selectivity in a tailing stream batch test is an indication of insufficient residence time in the circuit.

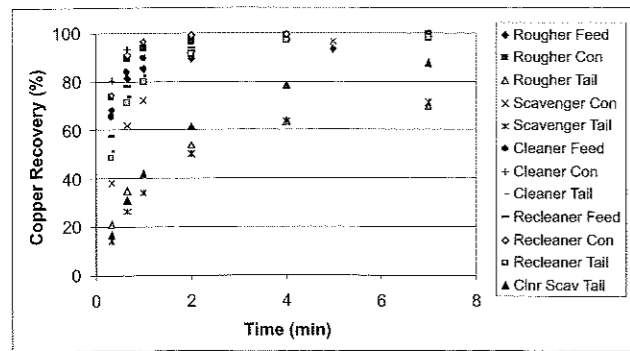

FIG 10 - Copper recoveries achieved in the batch tests performed on different streams in the Northparkes flotation circuit.

Streams with poor valuable mineral to gangue mineral selectivity are appropriate targets for regrinding or depressant or collector addition. Batch flotation of different streams in a flotation circuit enables the appropriate streams for this type of modification to be delineated from those that would not benefit from this type of processing.

Regular batch laboratory flotation test mapping during circuit surveys will provide a record of ore floatability properties – enabling the comparison of this property between different surveys.

**Nodal analysis comparisons**

The nodal analysis technique was developed to compare the floatability of particles before and after processes (ie nodes) within a flotation circuit (Runge *et al.*, 1997). It involves comparing the mineral recovery rate and selectivity achieved in batch laboratory flotation tests of the feed and product streams of a node. A node is defined as a point in a circuit where streams are either combined, separated or altered in some way (Figure 11). A node can be a single unit such as a flotation cell, a regrind mill or a pump sump, a combination of units (eg a bank of cells) or even an entire circuit with the feed being split into the final concentrate and final tailing stream.

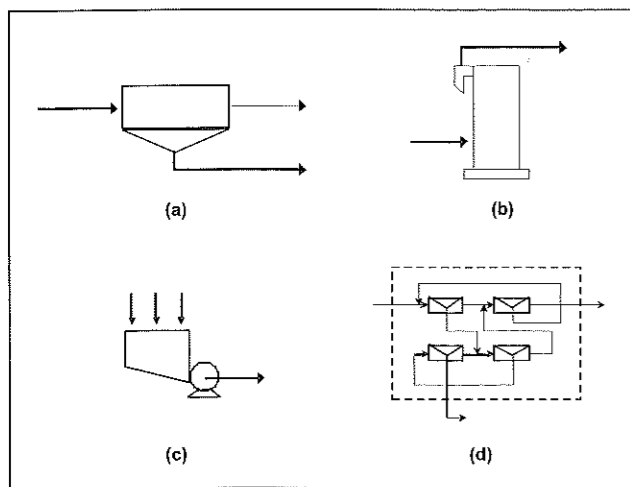

FIG 11 - Examples of nodes in a flotation circuit. (a) Flotation cell; (b) tower mill; (c) pump sump; (d) flotation circuit.

The experimental feed and product mineral recovery rates or mineral selectivity curves derived from laboratory batch flotation tests can be compared directly when there is only one feed stream and one product stream from a node.

This direct comparison is difficult, however, when there are multiple feed or product streams. In many cases it is also impossible to obtain 'the desired' samples from the flotation process. In these cases, the mineral recovery rate of a 'combined feed' or 'combined product' stream can be estimated by mathematically combining the experimental results of the standard laboratory batch flotation tests on two or more streams (Equation 2) based on their relative flows in the circuit.

$$R_{\text{Mineral } j}^{\text{Combined Stream, } t \text{ minutes}} = \frac{\sum_{s=1}^n F_{\text{Mineral } j}^{\text{Stream } s} \times R_{\text{Mineral } j}^{\text{Stream } s, t \text{ minutes}}}{\sum_{s=1}^n F_{\text{Mineral } j}^{\text{Stream } s}} \quad (2)$$

where:

$F_{\text{Mineral } j}^{\text{Stream } s}$  is the flow rate of mineral *j* in stream *s*  
 $R_{\text{Mineral } j}^{\text{Stream } s, t \text{ minutes}}$  is the cumulative recovery of mineral *j* in stream *s* after *t* minutes of flotation in the standard laboratory batch flotation test

Take for example a flotation column. A column has a single feed but two product streams. Equation 2 can be used to recombine the concentrate and tailing stream to produce a single 'combined' product stream result. The combined stream floatability can then be compared to the feed stream floatability to assess whether there has been any change across the unit. Figure 12 shows the galena recovery rate measured in a batch flotation test of the feed, concentrate and tailing streams of an industrial column. It also shows the calculated 'combined product' stream which, in this case, is very similar to the column feed. It can therefore be concluded that floatability does not change significantly across this unit. The difference in galena recovery rates in the concentrate and tailing stream is attributed to the faster floating galena-containing particles concentrating in the concentrate streams and the slower floating galena-containing particles concentrating in the tailing streams. Using this technique in a number of different flotation circuit operations, it has been shown that ore floatability is not often affected in a full-scale flotation cell (Runge *et al.*, 2006).

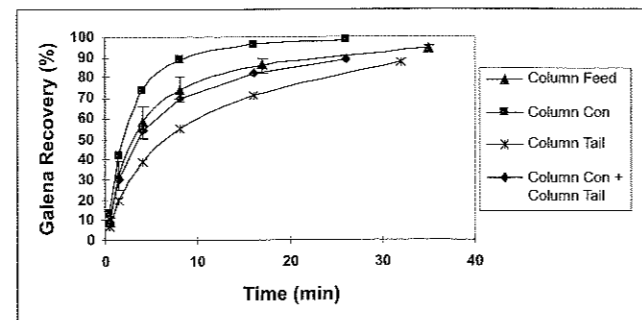

FIG 12 - Galena recovery versus time for the feed, concentrate, tailing and combined product of an industrial-scale flotation column (after Runge *et al.*, 1997).

Regrinding and reagent addition are employed in a flotation circuit specifically to alter particle floatability. Often the effectiveness of these processes is assessed by expensive and often inconclusive on-off testing. Comparison of ore floatability using nodal analysis techniques can enable a direct assessment of the effectiveness of these particle modification operations. In Figure 13a for example, it is obvious that staged reagent addition has resulted in a significant increase in the proportion of floatable copper in the circuit. In Figure 13b it is obvious that regrinding

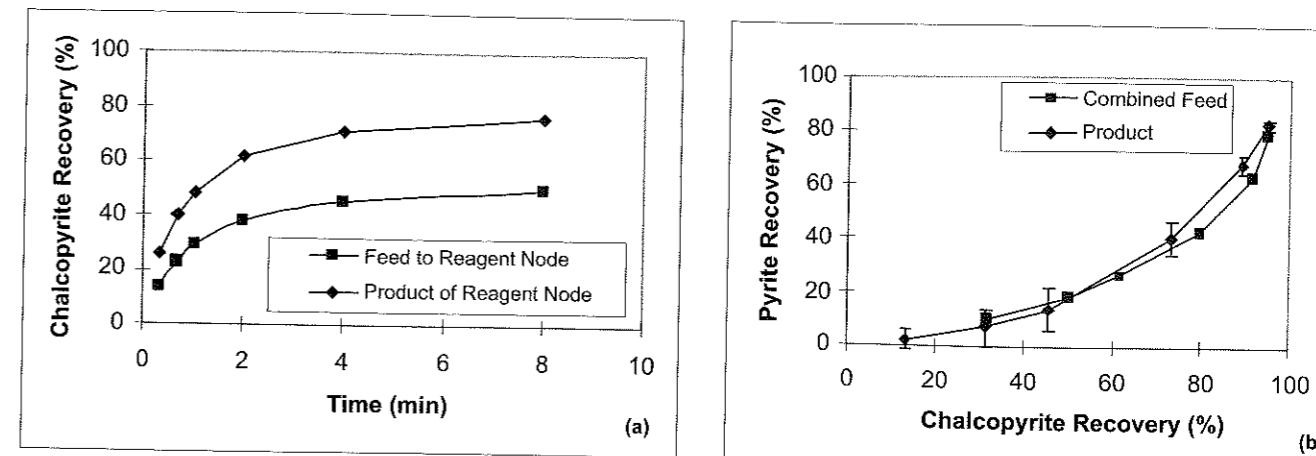

FIG 13 - Nodal analysis comparative graphs: (a) mineral recovery before and after collector addition, (b) chalcopyrite/pyrite selectivity before and after regrinding.

has not resulted in an improvement in the chalcopyrite/pyrite selectivity. These types of observations provide the metallurgist with invaluable information regarding the effect of an ore modification process.

These techniques will be demonstrated in a worked example included at the end of this chapter. For a more detailed example, the reader is referred to Runge, Franzidis and Manlapig, 2004 in which these techniques are used to assess the effect of staged reagent addition, regrinding and lime addition on ore floatability in an industrial circuit.

**Ore parameter estimation techniques**

The mineral recovery response measured in a laboratory batch flotation experiment can be used to calculate ore floatability parameters – numbers which represent the rate and extent to which a mineral will float. These parameters can be used as a means of comparison of different batch test experiments or within a flotation model for performance prediction.

Flotation is considered a first order kinetic process, recovery being a function of the time in the process (*t*) and a flotation rate constant (*k*). In a batch laboratory flotation environment, recovery can be calculated using Equation 3.

$$R = 1 - \exp(-kt) \quad (3)$$

The flotation rate constant is a function of the operating conditions in the cell and also the size, mineralogy and surface chemical speciation of the particles being floated. There are a number of different types of particles in an ore sample and each will float with a different flotation rate – thus an ore sample exhibits a distribution of floatabilities. There are no methods currently available for measuring each particle's individual rate. Instead the problem is simplified by assuming the form of the floatability distribution. The two methods most commonly used involve assuming a continuous shape for the distribution (eg rectangular distribution (Klimpel, 1980)) or splitting a mineral into different floatability components. In this chapter, derivation and use of multiple component parameters will be discussed. For those wanting more information regarding shaped distributions, the reader is referred to a paper written by Chander and Polat (1994).

Mineral recovery in a batch flotation test using multiple components can be calculated using Equation 4.

$$R = \sum_{i=1}^n m_i (1 - \exp(-k_i t)) \quad (4)$$

The rate of each component (*k<sub>i</sub>*) and the proportion of the mineral in that class (*m<sub>i</sub>*) are the ore floatability parameters of the system that can be derived from batch laboratory flotation test data. This involves calculating the 'best' set of these parameters that minimise the sum of squares difference between the recoveries calculated using Equation 4 and that measured in the laboratory batch flotation experiments. This difference can, optionally, be weighted by the standard deviation of the experimental data (Equation 5). These problems are easily set up on an Excel spreadsheet using the Solver add-in to perform the minimisation.

$$SSE = \sum_j \frac{(R_{j, \text{calculated}} - R_{j, \text{experimental}})^2}{SD_{j, \text{experimental}}^2} \quad (5)$$

The number of components that can be derived to describe a mineral's floatability is dependent on the amount of data available to do the parameter estimation. Unfortunately the data from a single batch laboratory flotation test is only sufficient to determine, with statistical confidence, the parameters associated with a simple representation of the system (one floating and one non-floating component). More complex representation requires an increase in the experimental data set size.

Harris (1998) recognised that this data set size could be increased by using information collected from laboratory batch flotation tests performed using different streams of a circuit. A circuit by its very nature results in a redistribution of the floatability components – fast floatability components predominantly reporting to the concentrate streams and the slower and non-floating components predominantly reporting to the tailing streams. If we assume that the feed consists of a number of floatability components, the other streams are also made up of these same floatability components, just in a different ratio. Analysis involves assuming the rate of each floatability component in the different batch tests is the same and that the mass of each floatability component is conserved across different nodes in the process. These constraints enable the data to parameter ratio to be significantly increased and enable parameters of multicomponent systems to be derived with statistical confidence. The measured distribution of floatability components in the different streams of an industrial flotation circuit derived using this type of analysis is shown in Figure 14.

In a similar vein, laboratory batch flotation tests can be performed with multiple stages or with recycle streams to increase the number of datapoints available for parameter

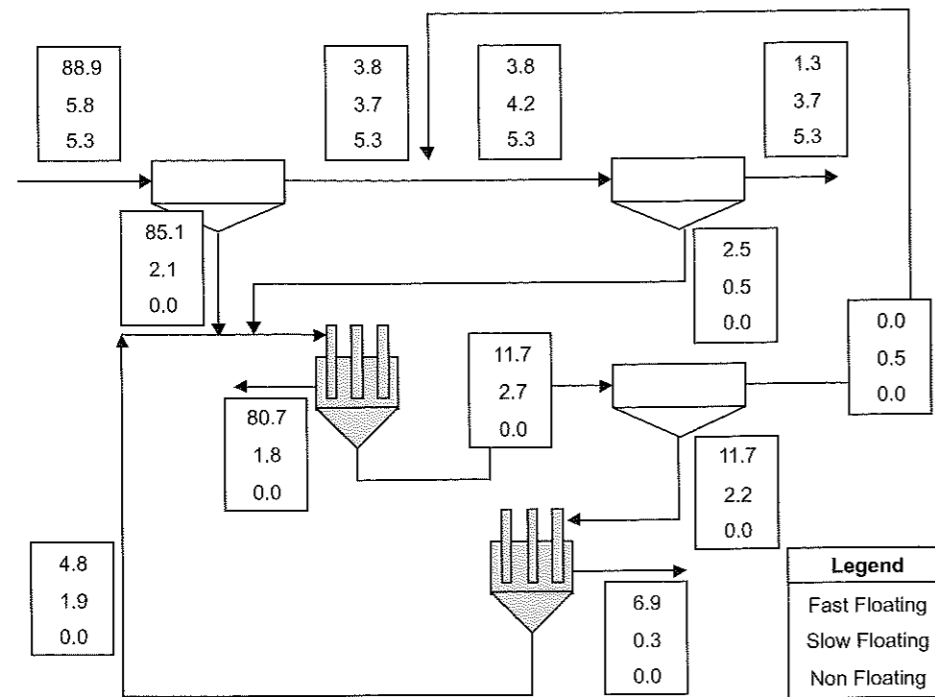

Fig 14 - Mass in different copper floatability components around the Northparkes industrial flotation circuit (based on 100 units of copper in the feed).

estimation. Thus multiple ore floatability parameter estimation can be performed without the need to collect samples from an operating flotation circuit.

A step by step worked example of the ore parameter derivation technique will be provided at the end of this chapter.

**Comparison of ore floatability parameters**

Ore floatability parameters provide the metallurgist with numbers that can be used to quantitatively assess and compare the floatability of ore in different laboratory batch flotation tests.

For optimal separability in a flotation circuit, the valuable mineral flotation rate should be high and the proportion of slow or non-floating valuable mineral should be minimised. Gangue flotation rates should ideally be low and a large proportion of the gangue mineral should be non-floatable. It will not be possible to separate mineral components of similar flotation rate so the ratio of the slow floating gangue to slow floating valuable mineral flotation rate is also an important parameter.

Hay and Rule (2003) characterised the ore floatability of the ore feeding a number of different platinum concentrators using a two floating component model. They found that the concentrate recovery and grade were strongly correlated with the fraction of fast floating valuable mineral with a proportion of the slow floating fraction being recoverable when the ratio of the slow valuable mineral to gangue flotation rate ratio was above a threshold value.

Ore floatability component mapping, as illustrated in Figure 14, can be used in conjunction with the mineral recovery and selectivity graphical information to assess the appropriate destination of recycle streams and the target streams for regrinding, collector or depressant addition.

**Simulation using ore floatability parameters**

The advantage of ore floatability parameters over the traditional graphical techniques, are that they can be used for prediction. Once determined, they can be used to rapidly investigate many

circuit scenarios. They can replace the need for complex lock cycle tests, giving estimates of the ultimate grade and recovery achievable in multistage flotation.

The aim of simulation is to calculate the distribution of floatability components across a proposed circuit. Beginning with the feed and the first unit in the circuit, recovery in the product streams are calculated. This calculation sequence is continued for each unit process, the product of earlier processes forming the feed to subsequent processes. Recycle streams during the first iteration are set to zero and multiple iterations of circuit calculations are performed until the mass in these recycle streams converges to a constant value. Once convergence has been achieved, the mass of the different floatability components of each mineral in each stream can be added together. These mineral masses can be used to calculate stream mineral grade (mineral mass divided by total mass in stream) and recovery (mass with respect to feed).

At each process in the circuit, recovery equations are used to calculate product component flows. Wherever streams are mixed, for instance, the mass of each floatability component in the product stream is equal to the addition of the mass of this same floatability component in the feed streams.

The recovery equation used for a flotation process is dependent on its particle residence time distribution. For a semi-batch process (like that performed in the laboratory batch flotation test) recovery of each component is calculated using Equation 3. Conventional mechanical cells behave as perfect mixers and thus have a different recovery equation (Equation 6).

$$R = \frac{k\tau}{1 + k\tau} \tag{6}$$

The flotation recovery equation can be extended to include parameters associated with entrainment and the cell operating variables (eg air rate, froth depth). Flotation cell water recovery equations are also required to calculate the circuit water flow information required for cell residence time calculations. For

more information on these types of simulations and the methods required to determine the parameters of these relationships, the reader is referred to Harris *et al*, 2002.

A simplification to these more complex models can be used to assess the separability of a particular ore in a particular flow sheet. The effect of the cell operating variables and residence time can be lumped into a single parameter, the cell operating constant,  $\theta$  (Loveday, 1966). Flotation recovery of a component is a function of only this parameter and its particular batch flotation test rate constant (Equation 7).

$$R = \frac{k_{batch}\theta}{1 + k_{batch}\theta} \tag{7}$$

Multiple simulations are performed for a particular flow sheet, with the cell operating constants,  $\theta$ , randomised in each stage. This randomisation is a representation of the range of different cell volumes/cell operating conditions which could be used to achieve flotation separation. It is equivalent to the flotation operator slowing or speeding up the process to achieve the desired concentrate grade and recovery at each stage.

The resulting final concentrate grade/recovery numbers from these simulations can be plotted. Figure 15 shows examples of the type of curves generated using this type of analysis. These curves were generated using ore floatability constants derived from batch laboratory experiments applied to a three stage flotation circuit. The result is not a single grade versus recovery relationship, as changes in the cell operating constant in one stage result in both a change in recovery but also a change in the separation efficiency of the circuit.

These curves can be generated to compare the floatability of different ore types (Figure 15b) or to compare the ability of different flow sheets to separate the minerals in a particular ore sample (Figure 16).

Simulations required to create these curves can be performed on an Excel spreadsheet. Alternatively, packages such as JKSimFloat and Limn<sup>®</sup> have been designed to enable these types of simulations to be performed rapidly in a user friendly environment.

**Estimation of full-scale residence time requirements**

The time it takes for a mineral to be recovered in a batch laboratory flotation test can be used to estimate the cell volume and the number of cells at full scale required to achieve this same recovery. Recovery rates in the batch cell environment are usually

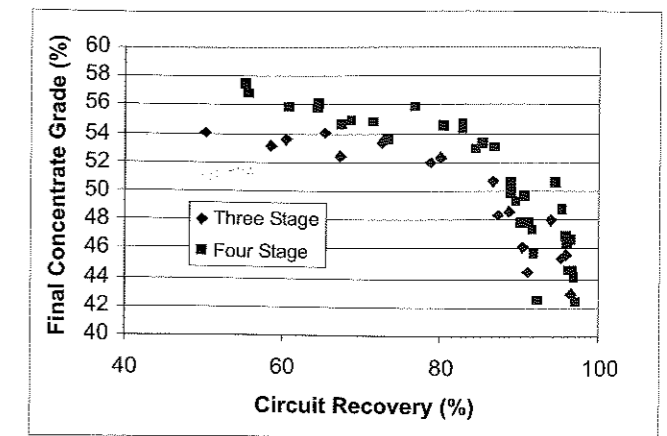
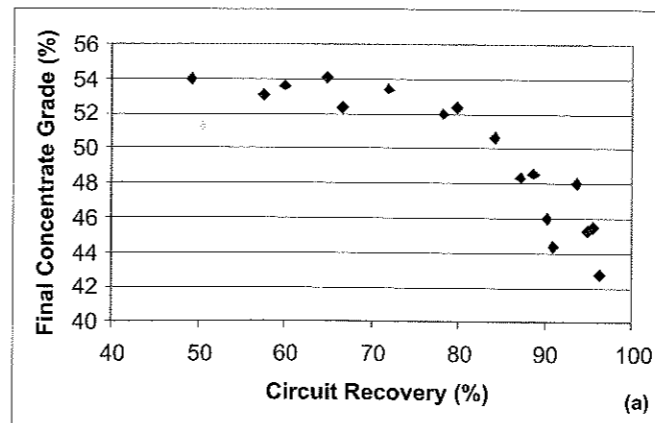

Fig 16 - Circuit grade and recovery simulated for the same ore processed in a three and four stage flotation circuit.

significantly higher than those measured at full scale due to the higher degree of turbulence and the higher froth recoveries achievable at small scale. A scale-up factor ( $C$ ) can be introduced to the full-scale recovery equation to account for these differences and relate full-scale recovery to the rate measured in a batch laboratory flotation test ( $k_{batch}$ ) (Equation 8).

$$R = \frac{Ck_{batch}\tau}{1 + Ck_{batch}\tau} \tag{8}$$

The cell scale-up factor is a complex function of the operating conditions at full scale and those used in the batch laboratory flotation test. It will also be strongly dependent on the ore and its effect on the full-scale froth characteristics. It is the author's recommendation that this scale-up factor be determined by comparing batch and full-scale kinetics in an existing concentrator processing a similar ore. The use of globally quoted scale-up factors (eg batch test rate is twice the rate at full scale) is not recommended as this factor changes significantly with the operating conditions used in both the batch test and full-scale cells.

Once the batch test ore floatability parameters and the scale-up factor have been established, simulations can be performed to determine the number of cells at a particular volume that are required to achieve the desired bank recovery. Additional capacity is usually factored into this analysis to account for any error and the usual increase in capacity (over design) often demanded from a flotation circuit over time.

Fig 15 - Circuit grade and recovery simulated in a three stage flotation circuit. (a) For a particular ore type, (b) for the same ore subject to different reagent/regrinding schemes.

**AREAS OF APPLICATION**

Laboratory batch flotation testing can be used as a diagnostic tool throughout the development and life of a flotation circuit.

Even before a project has commenced, batch laboratory flotation of drill core samples provide the information required to make decisions regarding a project's viability. Throughout the development of a flotation circuit flow sheet, batch tests are used to screen and determine the appropriate reagent suite and dosage rates, the target grind size and an estimate of the circuit residence time requirements.

From the day a flotation circuit is commissioned, the metallurgist strives to better understand the process and implement changes which will improve or optimise operation. Batch laboratory flotation testing is one of a suite of tools used in this process. New reagents are almost always screened first in these small tests before implementation at full scale.

After implementation of a change in grind size, reagent or circuit change at industrial scale, batch flotation tests can be used to assess the effect of the change on mineral recovery rates and selectivity.

The ore feeding a flotation circuit is continually changing as rock is extracted from different areas of the mine. Batch testing is a valuable tool for comparing the floatability of different ores or predicting the metallurgical performance that will be achieved when a particular ore is processed.

Flotation modelling techniques published in the literature (Harris *et al*, 2002; Runge *et al*, 2001; Coleman, Urtubia and Alexander, 2006) are using batch testing to determine ore characterisation properties. These models can be used for flotation circuit design, flotation circuit diagnosis and simulation of alternative operating strategies. They enable an estimation of the overall change in grade and recovery achievable in a particular process fed an ore with a particular mineral selectivity.

In summary, laboratory batch flotation testing is an essential tool, which when used appropriately, helps a metallurgist to design new flotation processes, develop strategies for improving a flotation circuit and ultimately assess the effectiveness of these strategies.

**ADVANTAGES AND LIMITATIONS OF USING BATCH FLOTATION TESTING FOR CIRCUIT DIAGNOSIS**

Small-scale batch laboratory tests are relatively cheap and easy to perform. Almost all concentrator laboratories are equipped with laboratory flotation cells and the associated equipment required to prepare and process the samples produced from a test. They also have the advantage that, to a significant degree, they replicate the flotation process that occurs at full scale.

Batch tests also have the advantage that they enable the ore floatability to be analysed in isolation to those effects related to circuit operation. Poor flotation recovery measured in a circuit survey can be due to a number of different effects: poor ore floatability, insufficient residence time, use of overly deep froth depths, to name a few. Batch laboratory tests are usually performed using the same operating conditions and thus any change between tests can be attributed solely to a difference in ore floatability. Batch tests performed in conjunction with circuit surveys can help decouple ore floatability and circuit operation effects and highlight the cause of flotation recovery loss.

What is often forgotten when analysing batch flotation test results, however, is that they are a good measure of pulp floatability but sometimes a poor indicator of full-scale froth phase performance. The froth in a small-scale laboratory test is only a couple of centimetres in depth and is continually removed.

In a full-scale cell the froth can be ten to 50 cm in depth and there are usually significant transportation distances between a point on the surface of the froth and the nearest launder. The froth produced in a small-scale cell is often very different in bubble size, texture and viscosity to that observed when the same ore is processed at full scale. This can result in a particular reagent suite, producing a superior pulp floatability (and thus batch test result) but poor recovery in a full-scale cell because of its effect on movement of the froth phase.

The primary assumption associated with batch laboratory test analysis is that pulp selectivity in the small scale is similar to what would be achieved in the full-scale flotation machine. It's likely this is a valid assumption in mechanical cells but less likely in alternative flotation technologies. The low degree of turbulence in a column, for instance, usually results in the poor recovery of coarse particles which are recovered quickly in a batch flotation test.

Another risk during batch laboratory flotation testing is the removal of loosely deposited surface coatings. The higher agitation energies which exist in a small-scale cell can sometimes remove molecules which would remain *in situ* in the full-scale flotation environment.

These limitations, as with most diagnostic techniques, mean that those conclusions drawn from batch laboratory testing should be verified through full-scale trials.

Much can be gained by performing batch laboratory flotation tests in conjunction with other measurements. Batch laboratory flotation tests indicate the overall result of a change. Sizing, mineralogical and chemical analysis tools can be used to determine the reason for a particular result, often suggesting alternative batch laboratory experiments to trial.

**CONCLUDING REMARKS**

In this chapter, batch laboratory testing procedures and the modelling and graphical techniques that can be used to analyse the results of these tests have been reviewed.

It has been demonstrated that batch laboratory flotation tests have a role to play throughout the lifetime of a particular flotation circuit operation. They can be used during the design of new flotation processes to develop strategies for improving a flotation circuit and, ultimately, to assess the effectiveness of these strategies.

They have the advantage that they are relatively cheap and easy to perform and to an extent, replicate the full-scale flotation process. They enable an assessment of ore floatability without the complication of changing cell operating variable effects. Effects, due to differences between the small-scale and full-scale cell, should be kept in mind when interpreting results.

The value of laboratory batch flotation testing is greatly enhanced when performed in parallel with other techniques that can assist with data interpretation.

**REFERENCES**

Chander, S and Polat, M, 1994. In quest of a more realistic flotation kinetics model, in *Proceedings IV Meeting of the Southern Hemisphere on Mineral Technology and III Latin American Congress on Froth Flotation* (eds: S Castro and J Alvarez), pp 481-500.

Coleman, R G, Urtubia, H E and Alexander, D J, 2006. A comparison of BHP Billiton's Minera Escondida flotation concentrators, in *Proceedings 38th Annual Meeting of the Canadian Mineral Processors*, pp 349-370 (Canadian Institute of Mining, Metallurgy and Petroleum: Montreal).

Harris, M C, 1998. The use of flotation plant data to simulate flotation circuits, in *Proceedings SAIMM Mineral Processing Design School* (Southern African Institute of Mining and Metallurgy: Johannesburg).

Harris, M C, Runge, K C, Whiten, W J and Morrison, R D, 2002. JKSimFloat as a practical tool for flotation process design and optimization, in *Mineral Processing Plant Design, Practice and Control*, vol 1, pp 461-478 (Society for Mining, Metallurgy, and Exploration: Littleton).

Hay, M P and Rule, C M, 2003. Supasim: A flotation plant design and analysis methodology, *Minerals Engineering*, 16(11):1103-1109.

Johnson, N W, 2005. A review of the entrainment mechanism and its modelling in industrial flotation processes, in *Proceedings Centenary of Flotation Symposium* (ed: G J Jameson), pp 487-496 (The Australasian Institute of Mining and Metallurgy: Melbourne).

Klimpel, R R, 1980. Selection of chemical reagents for flotation, in *Mineral Processing Plant Design*, Ch 45, pp 907-934 (The American Institute of Mining, Metallurgical, and Petroleum Engineers: Littleton).

Loveday, B K, 1966. Analysis of froth flotation kinetics, *Trans IMM*, 75:C219-C225.

Runge, K C, Dunglison, M E, Manlapig, E V and Franzidis, J-P, 2001. Floatability component modelling – A powerful tool for flotation circuit diagnosis, in *Proceedings Fourth International Symposium on Fundamentals of Minerals Processing*, pp 93-107 (Canadian Institute of Mining, Metallurgy and Petroleum: Montreal).

Runge, K C, Franzidis, J P and Manlapig, E V, 2004. Optimisation of flotation pulp selectivity utilising nodal analysis, in *Proceedings 36th Annual Meeting of the Canadian Mineral Processors*, pp 575-597 (Canadian Institute of Mining, Metallurgy and Petroleum: Montreal).

Runge, K C, Harris, M C, Franzidis, J P and Manlapig, E V, 2006. Conservation of floatability across processes in industrial flotation circuits, in *Proceedings XXIII International Mineral Processing Congress* (eds: G Onal, N Acarkan, *et al*), vol 3, pp 1909-1914 (Promed Advertising Agency).

Runge, K C, Harris, M C, Frew, J A and Manlapig, E V, 1997. Floatability of streams around the Comino Red Dog lead cleaning circuit, in *Proceedings Sixth Annual Mill Operators' Conference*, pp 157-163 (The Australasian Institute of Mining and Metallurgy: Melbourne).

**APPENDIX WORKED EXAMPLES**

**Example 1 – regrind evaluation**

A tower mill has been incorporated into the Eureka lead circuit to regrind lead rougher concentrate in an effort to improve liberation and thus the grade achievable in the lead flotation circuit concentrate.

Batch laboratory flotation tests were performed on the rougher concentrate and the reground rougher concentrate (after reagent addition) to assess whether this unit is having the desired effect.

Six timed concentrates and a tailing sample were produced from each test. Table A1 outlines the mineral grade measured in each of these samples.

This data was then used to calculate the cumulative grade and recovery achieved as a function of time in these tests. Figure A1 shows the grade versus recovery curve and Figure A2 shows the galena gangue selectivity curves.

**TABLE A1**  
Mineral grade of samples produced from batch flotation testing of a lead concentrate before and after grinding.

Sample	Time (min)	Before regrinding				After regrinding			
		Galena	Sphalerite	Pyrite	NSG	Galena	Sphalerite	Pyrite	NSG
Concentrate 1	0 - 0.5	76.71	14.08	4.02	5.20	72.80	14.86	6.77	5.58
Concentrate 2	0.5 - 1.5	68.66	20.80	5.73	4.81	68.54	17.67	7.66	6.13
Concentrate 3	1.5 - 4	48.42	31.44	9.12	11.03	57.27	25.34	9.52	7.87
Concentrate 4	4 - 8	25.88	45.83	16.35	11.95	28.29	44.10	15.60	12.00
Concentrate 5	8 - 12	18.17	50.83	21.40	9.60	15.99	50.99	19.02	14.01
Concentrate 6	12 - 20	12.54	51.77	23.49	12.21	12.19	50.05	20.80	16.96
Tailing		4.72	53.02	21.25	21.01	5.75	45.20	22.84	26.21

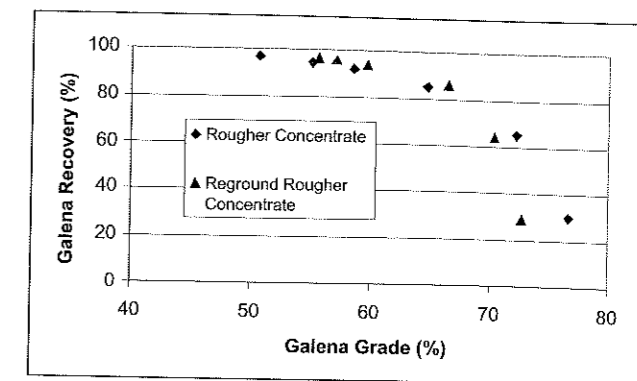

FIG A1 - Galena grade versus recovery achieved in batch flotation tests of the lead rougher concentrate before and after regrinding.

In contrary to what was expected, regrinding has not resulted in an improvement in the floatability of the ore. At low galena recoveries, the grade recovery relationship is significantly poorer in the 'after regrinding' batch test. At high galena recoveries, the relationship in the two tests is very similar.

This result is primarily due to deterioration in the pyrite-galena selectivity. Galena recovery rate has changed very little by the regrinding process, whereas there has been a significant increase in pyrite recovery (Figure A3). There is very little difference in the galena-sphalerite selectivity and a marginal improvement in galena-gangue selectivity.

The grinding environment often results in changes in the condition of particle surfaces – iron hydroxide coatings, for instance, can deposit on all surfaces during grinding with mild steel balls. Some change is occurring to the pyrite particles in this grinding system, resulting in an increased recovery rate. Surface chemical speciation of particle surfaces before and after grinding would almost certainly explain the reason for this observed result and maybe suggest strategies to reverse the effect.

Under the current chemical conditions, however, regrinding of lead concentrate should be discontinued.

**Example 2 – circuit survey comparison using nodal analysis**

Lime is used periodically in the zinc cleaner scavenger flow sheet (Figure A4) of the Eureka concentrate to depress pyrite. Debate reigns as to whether this lime results in an improvement in performance. To try and resolve the dispute between those advocating lime addition and those against it, two circuit surveys of the zinc cleaner scavenger flow sheet were performed – one with lime on and one with lime off. Batch laboratory tests were performed to measure the floatability of the feed, concentrate and

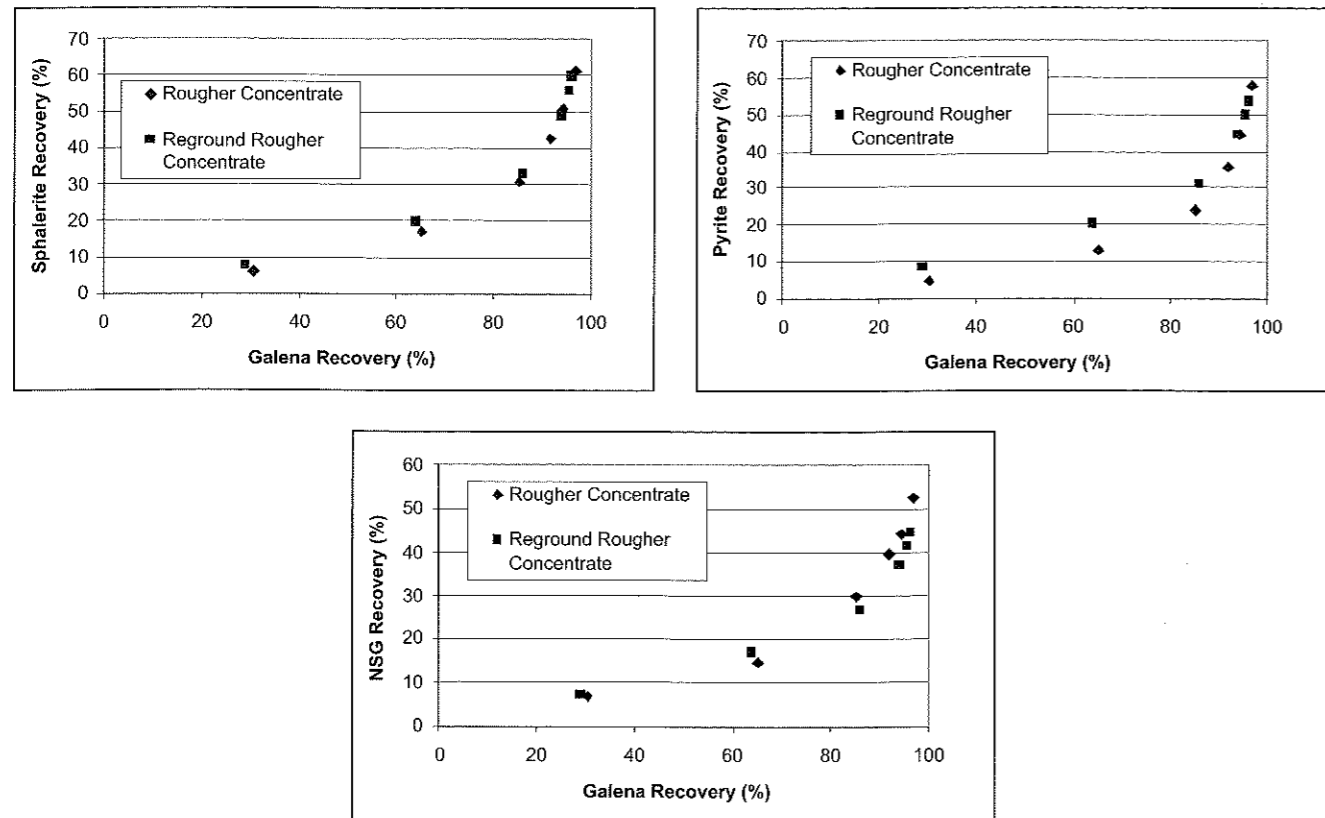

FIG A2 - Galena versus gangue mineral selectivity before and after regrinding of the lead rougher concentrate.

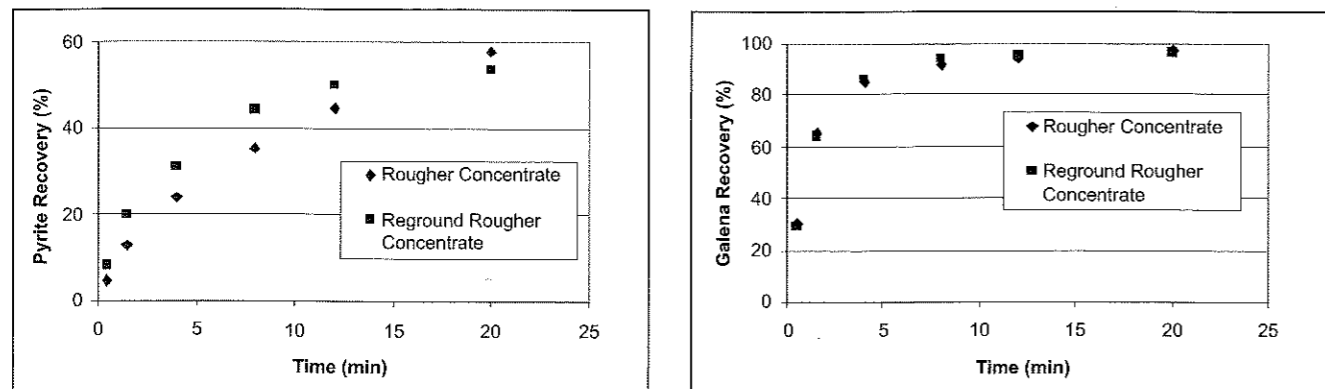

FIG A3 - Mineral recovery versus time before and after regrinding of the lead rougher concentrate.

final tailing of the circuit. Regrinding and staged reagent addition is also used within this section to optimise the zinc gangue selectivity in the circuit.

Results from the survey indicate that, although similar grade is achieved, zinc recovery is significantly lower in the survey performed when lime is added to the circuit (Table A2). This survey information alone fails to resolve the dispute. Those advocating lime addition suggest that the feed floatability and how the circuit was operated was probably very different during the two surveys.

Table A3 shows the cumulative mineral recovery data generated from the feed, concentrate and tailing sample batch laboratory flotation tests.

The feed mineral recovery rate curves of the various minerals can be compared to assess whether feed floatability is different between the two surveys. A review of Table A3 shows that the

sphalerite, galena and non-sulfide mineral recovery rates are very similar in the feed batch flotation tests. The pyrite recovery rate is low and thus sphalerite/pyrite selectivity of the feed is superior in the lime survey (Figure A5). It can therefore be concluded that the low recoveries in the lime survey are not due to poorer feed ore floatability.

Lime is supposed to improve sphalerite/pyrite selectivity by depressing pyrite in preference to sphalerite. The change in sphalerite/pyrite selectivity in the two circuit surveys can be assessed using nodal analysis techniques. The circuit is a node with a single feed and two product streams. The two product stream results can be combined using Equation A1 to create an estimate of the combined product floatability.

$$R_{\text{Mineral } j}^{\text{Combined Product, } t} = \frac{R_{\text{Mineral } j}^{\text{Concentrate}} \times R_{\text{Mineral } j}^{\text{Concentrate, } t} + R_{\text{Mineral } j}^{\text{Tail}} \times R_{\text{Mineral } j}^{\text{Tail, } t}}{100} \quad (\text{A1})$$

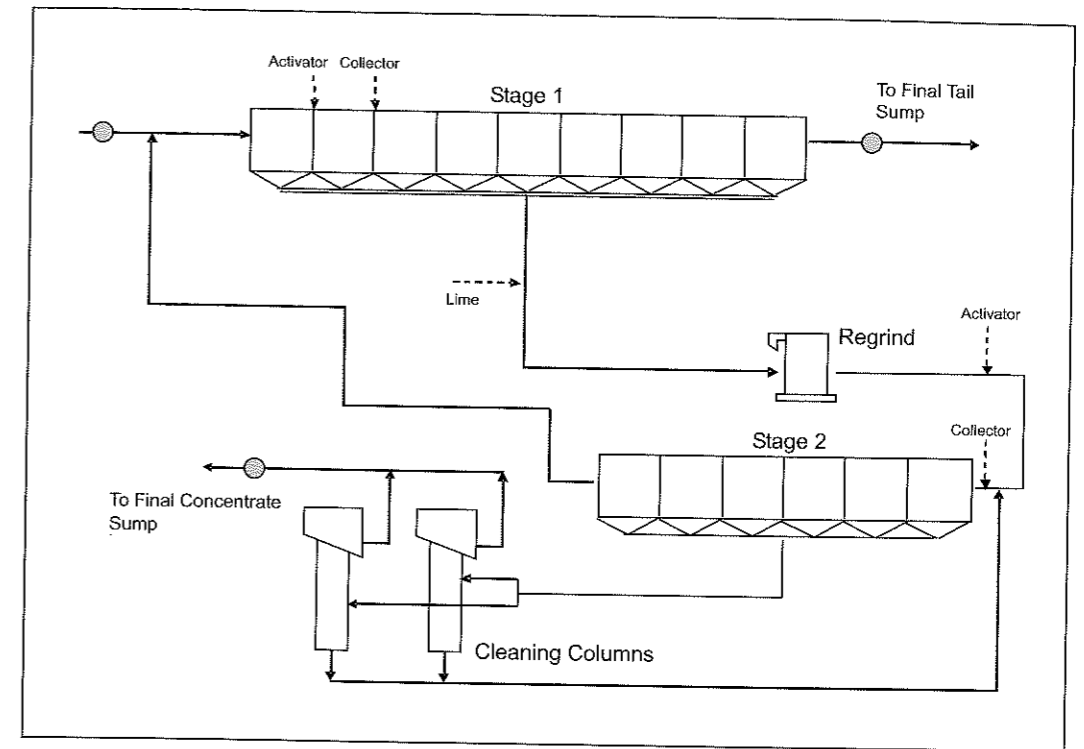

FIG A4 - Eureka zinc cleaner scavenging circuit.

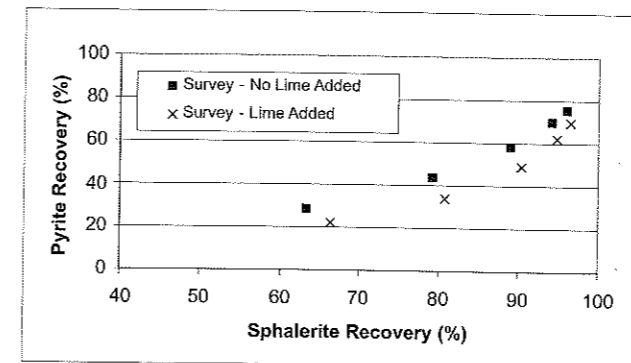

FIG A5 - Sphalerite/pyrite selectivity measured in the feed batch tests performed during the two circuit surveys.

the sphalerite/pyrite selectivity in the feed and product streams of this particular circuit. Sphalerite/pyrite selectivity in the survey when lime is not added, improves dramatically across the circuit. It can therefore be concluded that regrinding and the reagent addition during this survey have had a positive effect on the ability to separate sphalerite and pyrite. In contrast, sphalerite, pyrite selectivity deteriorates in the survey in which lime is added.

This deterioration in sphalerite/pyrite selectivity is due to a decrease in the sphalerite recovery rate (in contrast to an increase when lime is not added to the circuit) and a small but similar decrease in the recovery of pyrite (Figure A7).

Use of nodal analysis in this example has shown that lime addition in the circuit does not result in appreciable improvements in sphalerite/pyrite selectivity. The deterioration in valuable to gangue mineral selectivity will have had a significant impact on the ability to separate minerals in this circuit. Adjustments in circuit operation would have occurred to maintain grade but at a cost of losing zinc recovery.

As a confirmation of this conclusion, nodal analysis was also performed before and after lime addition in this circuit (Runge *et al.*, 2004). These tests show that lime addition dramatically decreases the floatability of all minerals, but sphalerite in particular.

It thus can be concluded that lime addition is clearly not the solution to improving pyrite/selectivity in this circuit. Batch laboratory testing performed in conjunction with survey work enabled a more definitive analysis of circuit operation.

where:

- $R_{\text{Mineral } j}^{\text{Concentrate}}$  is the recovery of mineral  $j$  to concentrate
- $R_{\text{Mineral } j}^{\text{Tail}}$  is the recovery to tailing of mineral  $j$
- $R_{\text{Mineral } j}^{\text{Combined Product, } t}$  is the cumulative recovery of mineral  $j$  in the combined product after  $t$  minutes of flotation

The results of this calculation are shown in Table A4.

Once the combined product floatability has been calculated, feed and product mineral recoveries can be compared. Figure A6 shows

TABLE A2  
Metallurgical performance achieved during each survey.

Details of survey	Concentrate grade (%)				Recovery to concentrate (%)			
	Galena	Sphalerite	Pyrite	NSG	Galena	Sphalerite	Pyrite	NSG
No lime added	6.2	79.7	7.0	7.2	57.8	86.2	11.4	5.5
Lime added	5.0	79.0	8.0	8.0	33.0	61.5	8.4	4.2

**TABLE A3**

Cumulative mineral recovery achieved in the feed, concentrate and tailing batch tests performed during the two circuit surveys.

Cumulative time (min)	Mineral cumulative recovery in feed batch test							
	No lime addition				Lime addition			
	Galena	Sphalerite	Pyrite	NSG	Galena	Sphalerite	Pyrite	NSG
0.33	22.5	33.3	10.8	7.5	23.2	36.4	9.7	10.3
1	49.9	63.4	28.2	19.8	49.0	66.6	22.2	21.8
2	66.8	79.1	43.3	29.9	65.7	80.7	33.5	31.8
4	82.4	89.2	58.0	40.9	79.3	90.4	48.3	42.0
8	89.5	94.3	69.6	51.1	87.7	94.8	62.1	52.2
12	92.4	96.1	75.5	57.6	91.2	96.5	69.7	58.9

Cumulative time (min)	Mineral cumulative recovery in concentrate batch test							
	No lime addition				Lime addition			
	Galena	Sphalerite	Pyrite	NSG	Galena	Sphalerite	Pyrite	NSG
0.33	32.2	37.5	18.9	16.6	19.3	22.9	15.0	16.6
1	68.6	74.9	42.1	38.2	46.8	53.8	37.7	36.9
2	86.0	90.4	59.3	52.7	65.2	73.2	52.5	52.3
4	94.7	97.3	76.2	68.7	80.4	87.8	67.6	67.7
8	98.0	99.1	89.0	81.1	91.1	96.0	81.5	83.0
12	98.7	99.5	91.8	83.8	94.6	98.0	87.4	88.5

Cumulative time (min)	Mineral cumulative recovery in tailing batch test							
	No lime addition				Lime addition			
	Galena	Sphalerite	Pyrite	NSG	Galena	Sphalerite	Pyrite	NSG
0.33	13.5	24.2	8.4	6.2	13.8	18.7	7.6	5.9
1	31.7	53.0	23.0	11.6	33.9	41.2	19.0	13.8
2	46.8	68.4	35.9	17.5	49.5	56.0	29.9	20.0
4	61.0	77.1	48.1	25.7	62.9	67.0	40.7	25.7
8	73.0	84.1	62.6	35.0	75.2	75.9	53.8	34.2
12	77.4	86.0	67.2	40.1	80.2	79.3	60.6	39.7

**TABLE A4**

Cumulative mineral recovery of the combined product streams from the two circuit surveys.

Cumulative time (min)	Mineral cumulative recovery in combined product							
	No lime addition				Lime addition			
	Galena	Sphalerite	Pyrite	NSG	Galena	Sphalerite	Pyrite	NSG
0.33	24.3	35.7	9.6	6.8	15.6	21.2	8.2	6.3
1	53.0	71.9	25.2	13.1	38.2	49.0	20.6	14.7
2	69.5	87.4	38.6	19.4	54.7	66.6	31.8	21.4
4	80.5	94.5	51.3	28.1	68.7	79.8	43.0	27.5
8	87.4	97.0	65.6	37.5	80.4	88.2	56.2	36.3
12	89.7	97.6	70.0	42.5	85.0	90.8	62.9	41.8

**Example 3 – ore floatability parameter modelling of laboratory batch test data**

There is a concern that a future ore to be fed to the Eureka concentrator will be more difficult to treat in the lead circuit than the current ore. Liberation analysis has indicated it has a more complex lead mineralogy.

A multiple stage batch laboratory flotation test was performed using the future ore to enable its ore floatability parameters to be determined and compared to those of the current ore. Grind size and reagent dosage rates were similar to those used in the plant. The test involved floating a sample of the future ore for eight

minutes with two samples of concentrate collected – one from the first two minutes (denoted rougher concentrate) and one from the two to eight minute time period (denoted scavenger concentrate). The rougher concentrate was then refloatated in a cleaner stage where concentrates were collected from zero to 20 seconds, 20 to 40 seconds, 40 to 60 seconds and from one to two minutes. The scavenger concentrate was then combined with the tailing from the cleaner stage and refloatated in a cleaner scavenger stage for six minutes. Concentrates were collected from zero to 0.5 minutes, 0.5 to one minute, one to two minutes and two to six minutes. A diagram depicting the stages of the test and samples produced is shown in Figure A8.

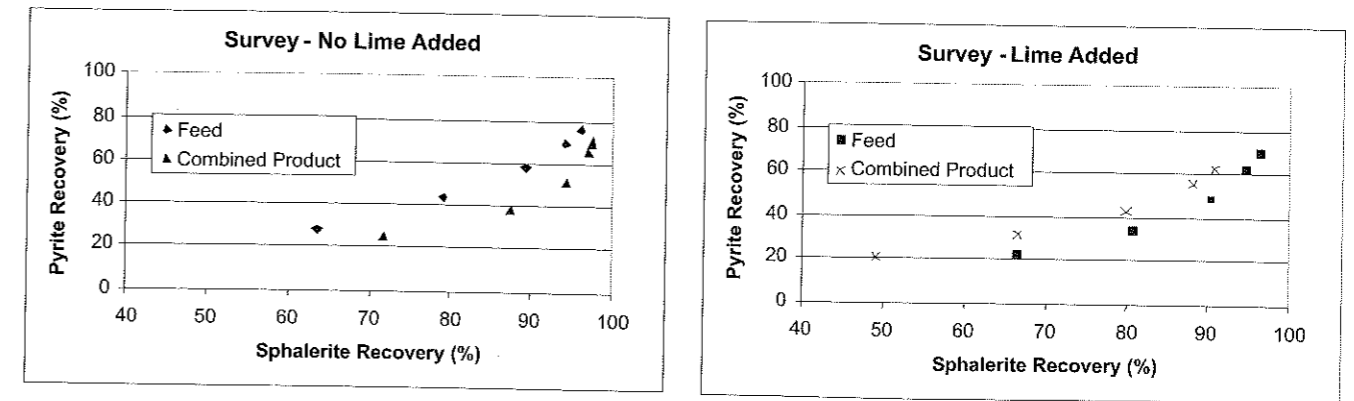

FIG A6 - Sphalerite/pyrite selectivity measured in the feed and product of the two circuit surveys.

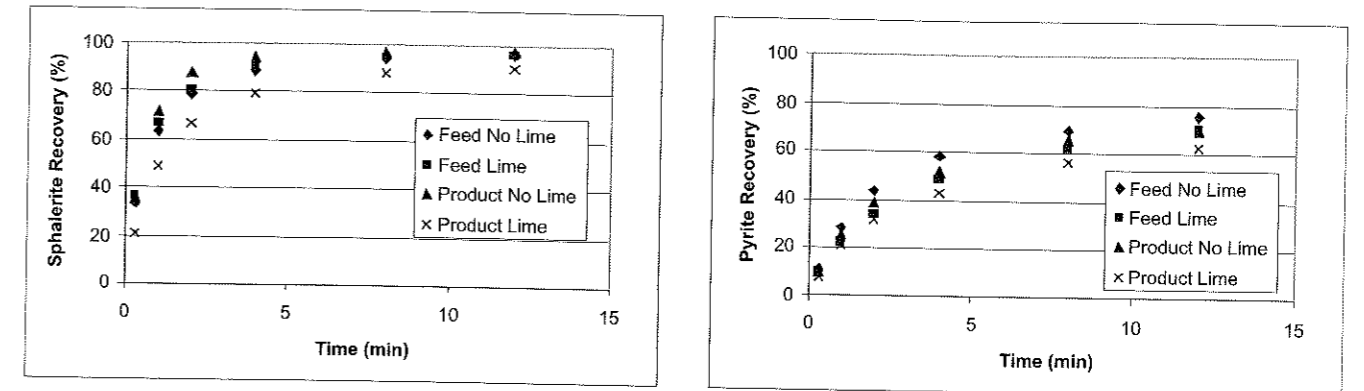

FIG A7 - Sphalerite and pyrite recovery rates measured in the feed and product of the two circuit surveys.

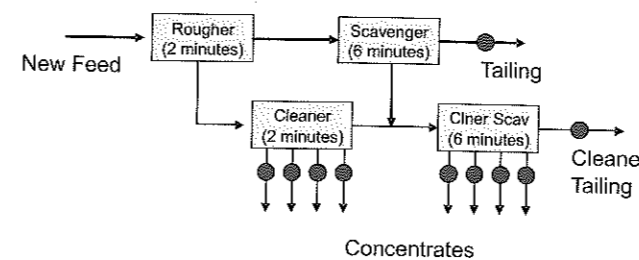

FIG A8 - Representation of multiple stage batch laboratory flotation test – samples produced denoted by a red circle.

The samples produced from the test were dried and weighed and analysed for lead content – the results of which are shown in Table A5.

It is decided to represent the ore floatability of the system by three lead components (fast, slow and non-floating lead) and three gangue components (fast, slow and non-floating gangue). Three components are the maximum number that could be derived with confidence from the experimental data available. Gangue is a term to refer to the weight in each sample that is 'not lead'. To determine the flotation rate and proportion of lead and gangue in each of the floatability components, an Excel spreadsheet was set up to calculate the weight and assay of the experimental samples based on a flotation model. Solver, an add-in tool to Excel, was then used to determine the ore floatability parameters that minimise the difference between the measured and calculated sample information.

Table A6, Table A7 and Table A8 show the calculation tables that were set up in Excel to perform the calculations.

Table A9 shows the calculation of the weight of lead in each batch test sample based on any set of lead floatability parameters.

**TABLE A5**  
Multiple stage batch test results.

Sample	Solids (g)	% Lead	% Gangue
Cleaner concentrate 1	13.4	75.9	24.1
Cleaner concentrate 2	10.0	74.0	26.0
Cleaner concentrate 3	7.5	71.9	28.1
Cleaner concentrate 4	13.5	67.3	32.7
Cleaner scavenger concentrate 1	9.2	55.8	44.2
Cleaner scavenger concentrate 2	6.7	50.5	49.5
Cleaner scavenger concentrate 3	8.9	42.8	57.2
Cleaner scavenger concentrate 4	14.5	25.7	74.3
Cleaner scavenger tailing	19.6	7.2	92.8
Tailing	2096.7	0.9	99.1
Recalculated feed	2200.0	3.1	96.9

The calculation is performed in three tables. The first table contains the parameters to be derived from the fitting exercise. The values first input into the table are an estimate. Note that the rate and mass fraction of the non-floating component are not fitted parameters. The rate of the non-floating component is zero and the proportion of material in the non-floating component is one minus the fraction in the other components.

The second table calculates the recovery of each component in each stage of the batch test ( $R_c$ ). Recovery is a function of the flotation rate of the component ( $k_c$ ) and the time of flotation ( $t$ ) (Equation A2).

$$R_c = 1 - \exp(-k_c t) \tag{A2}$$



**TABLE A6**  
Lead flotation model Excel spreadsheet.

Parameter table	Fast	Slow	Non
Lead flotation rates (min <sup>-1</sup> )	0.932	0.201	0.000
Proportion of lead in feed in each component	0.642	0.099	0.258

Stage recovery matrix	Time (min)	Calculated recovery in stage		
		Fast	Slow	Non
Rougher	2	84.5%	33.1%	0.0%
Scavenger	6	99.6%	70.1%	0.0%
Cleaner 1	0.333	26.7%	6.5%	0.0%
Cleaner 2	0.333	26.7%	6.5%	0.0%
Cleaner 3	0.333	26.7%	6.5%	0.0%
Cleaner 4	1	60.6%	18.2%	0.0%
Cleaner scavenger 1	0.5	37.3%	9.6%	0.0%
Cleaner scavenger 2	0.5	37.3%	9.6%	0.0%
Cleaner scavenger 3	1	60.6%	18.2%	0.0%
Cleaner scavenger 4	4	97.6%	55.3%	0.0%

Component distribution matrix	Weight of component in sample			
	Fast	Slow	Non	Total
<b>Batch test sample</b>				
Feed	43.84	6.78	17.64	68.26
Rougher concentrate	37.05	2.25	0.00	39.29
Scavenger concentrate	6.77	3.18	0.00	9.95
Tailing	0.03	1.35	17.64	19.02
Cleaner feed (rougher concentrate)	37.05	2.25	0.00	39.29
Cleaner concentrate 1	9.89	0.15	0.00	10.03
Cleaner concentrate 2	7.25	0.14	0.00	7.39
Cleaner concentrate 3	5.31	0.13	0.00	5.44
Cleaner concentrate 4	8.85	0.34	0.00	9.19
Cleaner tail	5.75	1.50	0.00	7.25
Cleaner scavenger feed (SC + CT)	12.51	4.68	0.00	17.19
Cleaner scavenger concentrate 1	4.66	0.45	0.00	5.11
Cleaner scavenger concentrate 2	2.93	0.41	0.00	3.33
Cleaner scavenger concentrate 3	2.99	0.70	0.00	3.68
Cleaner scavenger concentrate 4	1.89	1.73	0.00	3.62
Cleaner scavenger tailing	0.05	1.40	0.00	1.44
Combined cleaner concentrate	31.30	0.74	0.00	32.05
Combined cleaner scavenger concentrate	12.47	3.28	0.00	15.75
Total concentrate	43.77	4.03	0.00	47.79
Total tailings	0.07	2.75	17.64	20.47

In the final table, the weight of each component in each batch test sample throughout the duration of the test is calculated. The weight in each component in the test feed is established by multiplying the total weight of lead in the feed (an input) by the proportion of lead in each component as specified in the first table. The weight in the concentrate of each stage is determined by multiplying the weight in the feed to the stage by the stage recovery (R<sub>s</sub>). The weight in the tail of each stage is the feed minus the concentrate weight. These calculations are performed

in sequence, with either the concentrate or tailing (or both in the case of the cleaner scavenger feed) of previous stages becoming the feed to subsequent stages.

The total weight of lead reporting to each concentrate or tailing stream in the batch test is then calculated by summing the weights of its floatability components.

The identical calculation sequence is performed to determine the mass of gangue in each of the batch test samples according to a set of gangue specific floatability components (Table A7).

**TABLE A7**  
Gangue flotation model Excel spreadsheet.

Parameter table	Fast	Slow	Non
Gangue flotation rates	0.654	0.099	0.000
Proportion of gangue in feed in each component	0.009	0.030	0.961

Stage recovery matrix	Time (min)	Calculated recovery in stage		
		Fast	Slow	Non
Rougher	2	73.0%	17.9%	0.0%
Scavenger	6	98.0%	44.7%	0.0%
Cleaner 1	0.333	19.6%	3.2%	0.0%
Cleaner 2	0.333	19.6%	3.2%	0.0%
Cleaner 3	0.333	19.6%	3.2%	0.0%
Cleaner 4	1	48.0%	9.4%	0.0%
Cleaner scavenger 1	0.5	27.9%	4.8%	0.0%
Cleaner scavenger 2	0.5	27.9%	4.8%	0.0%
Cleaner scavenger 3	1	48.0%	9.4%	0.0%
Cleaner scavenger 4	4	92.7%	32.6%	0.0%

Component distribution matrix	Weight of component in sample			
	Fast	Slow	Non	Total
<b>Batch test sample</b>				
Feed	19.70	63.15	2050.89	2133.74
Rougher concentrate	14.37	11.32	0.00	25.70
Scavenger concentrate	5.22	23.18	0.00	28.40
Tailing	0.11	28.65	2050.89	2079.65
Cleaner feed (rougher concentrate)	14.37	11.32	0.00	25.70
Cleaner concentrate 1	2.81	0.37	0.00	3.18
Cleaner concentrate 2	2.26	0.35	0.00	2.62
Cleaner concentrate 3	1.82	0.34	0.00	2.16
Cleaner concentrate 4	3.59	0.96	0.00	4.55
Cleaner tail	3.89	9.29	0.00	13.18
Cleaner scavenger feed (SC + CT)	9.11	32.47	0.00	41.58
Cleaner scavenger concentrate 1	2.54	1.56	0.00	4.11
Cleaner scavenger concentrate 2	1.83	1.49	0.00	3.32
Cleaner scavenger concentrate 3	2.27	2.77	0.00	5.04
Cleaner scavenger concentrate 4	2.28	8.70	0.00	10.98
Cleaner scavenger tailing	0.18	17.95	0.00	18.13
Combined cleaner concentrate	10.49	2.03	0.00	12.51
Combined cleaner scavenger concentrate	8.93	14.52	0.00	23.45
Total concentrate	19.42	16.55	0.00	35.96
Total tailings	0.29	46.60	2050.89	2097.78

The weight of lead and gangue calculated in each stream can be used to calculate the total weight of solids and the lead and gangue assay of each batch test sample. This calculated assay is then compared to the actual assay measured during the test (Table A8).

To calculate the total sum of squares error associated with the system, the error of each experimental datapoint must be estimated. For this exercise, the Whiten function is used to estimate the standard deviation of the assays (Equation A3) and a relative error of 2.5 per cent is used as the error of the solid weights.

$$SD = 1 \text{ if assay} > 9\% \\ SD = \text{assay} / 10 + 0.1 \text{ if assay} < 9\% \quad (A3)$$

The squared error associated with each experimental datapoint is calculated using Equation (A4). The total sum of squares error is the sum of the squared errors.

$$SE = \frac{(d_{\text{calculated}} - d_{\text{experimental}})^2}{SD_{\text{experimental}}^2} \quad (A4)$$

**TABLE A8**

Calculation of the sum of squares error associated with the model fit.

Batch test sample	Calculated data			Experimental data			Standard deviation			Squared error			
	Assay		Solids (g)	Assay		Solids (g)	Assay		Solids (g)	Assay		Solids (g)	
	Lead	Gangue		Lead	Gangue		Lead	Gangue		Lead	Gangue		
Feed	3.10	96.90	2202.00										
Rougher concentrate	60.46	39.54	64.99										
Scavenger concentrate	25.94	74.06	38.34										
Tailing	0.91	99.09	2098.67	0.85	99.13	2096.7	0.19	1.00	52.4	0.09	0.00	0.00	
Cleaner feed (rougher concentrate)	60.46	39.54	64.99										
Cleaner concentrate 1	75.94	24.06	13.21	76.7	24.09	13.4	1.00	1.00	0.3	0.58	0.00	0.22	
Cleaner concentrate 2	73.84	26.16	10.00	73.1	25.97	10.0	1.00	1.00	0.3	0.54	0.04	0.00	
Cleaner concentrate 3	71.56	28.44	7.60	71.0	28.09	7.5	1.00	1.00	0.2	0.31	0.13	0.10	
Cleaner concentrate 4	66.85	33.15	13.74	65.0	32.67	13.5	1.00	1.00	0.3	3.43	0.23	0.36	
Cleaner tail	35.48	64.52	20.43										
Cleaner scavenger feed (SC + CT)	29.25	70.75	58.77										
Cleaner scavenger concentrate 1	55.45	44.55	9.22	58.3	44.16	9.2	1.00	1.00	0.2	8.10	0.15	0.03	
Cleaner scavenger concentrate 2	50.07	49.93	6.65	48.2	49.51	6.7	1.00	1.00	0.2	3.49	0.18	0.02	
Cleaner scavenger concentrate 3	42.23	57.77	8.72	41.1	57.17	8.9	1.00	1.00	0.2	1.28	0.36	0.39	
Cleaner scavenger concentrate 4	24.81	75.19	14.60	24.0	74.35	14.5	1.00	1.00	0.4	0.65	0.71	0.06	
Cleaner scavenger tailing	7.38	92.62	19.57	7.5	92.79	19.6	0.82	1.00	0.5	0.02	0.03	0.00	
Combined cleaner concentrate	71.92	28.08	44.56										
Combined cleaner scavenger concentrate	40.18	59.82	39.20										
Total concentrate	57.06	42.94	83.76										
Total tailings	0.97	99.03	2118.24										
												Sum of squares error	21.52

**TABLE A9**

Stage batch test ore floatability results.

Parameter	Future ore			Current ore		
	Fast	Slow	Non	Fast	Slow	Non
Lead flotation rates	0.93	0.20	0.0	0.99	0.16	0.0
Proportion of lead in each component in feed	0.64	0.10	0.26	0.71	0.08	0.21
Gangue flotation rates	0.65	0.10	0.0	0.62	0.07	0.0
Proportion of gangue in each component in feed	0.009	0.03	0.96	0.007	0.02	0.97

Once the spreadsheet has been set up in the way described above, Solver (an add-in tool in Excel) can be used to determine the lead and gangue parameters which minimise the total sum of squares error. For this example, Solver is able to find a set of parameters which result in a good fit to the experimental data.

In Table A9, the parameters derived from the analysis above are compared to those derived from a similar test performed using the ore currently processed by the plant.

The flotation rates of the different components in the two different ores are similar. The ore does have poorer floating characteristics than the current ore. The proportion of floatable lead is significantly lower and the proportion of floatable gangue has increased. This is an indication that the future ore is less liberated at the grind size tested.

The flotation model that was developed to determine the ore parameters can also be used to simulate various different batch test configurations – predicting the change in grade and recovery that would be produced if the test was run in a different way.

To use the model, the parameters of the ore are input into the parameter table and the time of each stage is input into the stage recovery matrix. The lead grade and lead recovery of the combined concentrate (cleaner and cleaner scavenger concentrate) is calculated by the model. Using the parameters derived for the current ore and the future ore, the model was used to predict the combined concentrate lead grade and recoveries that would be achieved if different times were used in the various stages of the batch test. Table A10 show the different simulations that were performed and the results. Figure A9 shows a graphical comparison of the results derived for the two ores.

**TABLE A10**

Multiple stage batch test simulation results.

Model simulation	Batch test stage time				Future ore		Current ore	
	Rougher	Scavenger	Cleaner	Cleaner scavenger	Lead grade	Lead recovery	Lead grade	Lead recovery
Base case	2.00	6.00	2.00	6.00	57.06	70.02	70.44	74.72
Simulation 1	2.00	6.00	0.50	1.50	66.69	55.63	77.69	61.67
Simulation 2	4.00	12.00	2.00	6.00	52.54	71.41	66.97	75.92
Simulation 3	6.00	18.00	2.00	6.00	50.52	71.78	65.05	76.32
Simulation 4	12.00	24.00	2.00	6.00	48.91	72.04	63.26	76.61
Simulation 5	12.00	24.00	4.00	12.00	43.01	73.71	57.32	78.28
Simulation 6	12.00	24.00	1.00	3.00	55.64	68.08	69.04	73.31
Simulation 7	6.00	18.00	1.00	3.00	57.03	67.83	70.34	73.08
Simulation 8	2.00	6.00	1.00	3.00	62.21	66.21	74.16	71.71
Simulation 9	2.00	6.00	0.50	1.50	66.69	55.63	77.69	61.67
Simulation 10	1.00	3.00	0.50	1.50	69.76	52.34	79.80	58.69
Simulation 11	1.00	3.00	1.00	3.00	66.11	62.97	76.87	69.06
Simulation 12	1.00	3.00	2.00	6.00	62.02	66.60	73.98	72.02

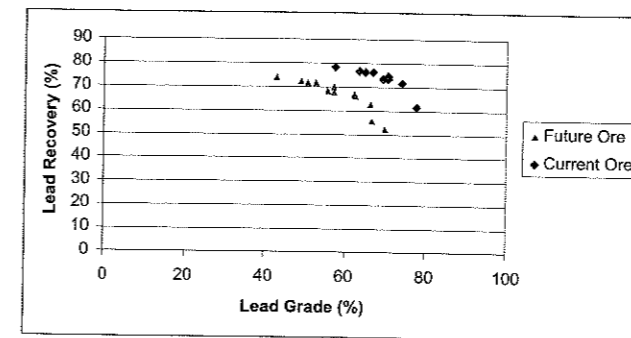

FIG A9 - Simulated batch test lead grade and recovery of the future and current ore.

The ore floatability of the future ore, as measured in the batch flotation test, is clearly poorer than that currently treated. The lead recovery achievable at a particular grade is ten per cent lower in the future ore simulations than in the current ore simulations. Increased recoveries may be possible at a finer grind. Additional test work would be required to substantiate this hypothesis.